



Boring



Reaming



Burnishing



Threading



Specials



T-A Pro®

▶ **DRILLING**

High Penetration Replaceable Insert Drilling System

SECTION

A25

T-A Pro®

T-A Pro[®]

High Penetration Replaceable Insert Drilling System

► Diameter Range: 11.10mm - 47.80mm (0.437" - 1.882")



The best just got *better*.

After 35 years of spade drilling success with our iconic T-A[®] (Throw Away) insert, the best just got better. Our team of engineers developed technology that takes THE "go-to" solution for general purpose holemaking to a performance level previously unachievable by a spade insert.

The T-A Pro combines material-specific insert geometries, a redesigned drill body, and a proprietary trough coolant system to allow penetration rates, which run at speeds faster than other high performance drills.

Excellent chip control	Improves hole quality and surface finish	Provides maximum durability and stability
------------------------	--	---

Applicable Industries

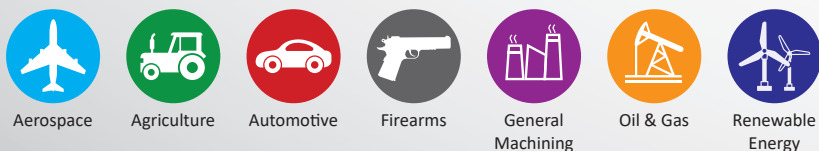

Your safety and the safety of others is very important. This catalog contains important safety messages. Always read and follow all safety precautions.



This triangle is a safety hazard symbol. It alerts you to potential safety hazards that can cause tool failure and serious injury.

When you see this symbol in the catalog, look for a related safety message that may be near this triangle or referred to in the nearby text.

There are safety signal words also used in the catalog. Safety messages follow these words.

⚠ WARNING

WARNING (shown above) means that failure to follow the precautions in this message could result in tool failure and serious injury.

NOTICE means that failure to follow the precautions in this message could result in damage to the tool or machine but not result in personal injury.

NOTE and **IMPORTANT** are also used. These are important that you read and follow but are not safety-related.

Visit www.alliedmachine.com for the most up-to-date information and procedures.

T-A Pro Drilling System Contents

Reference Icons

The following icons will appear throughout the catalog to help you navigate between products.

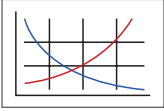

Recommended Cutting Data
Speed and feed recommendations for optimum and safe boring

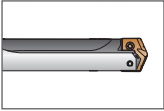

T-A Pro Holders
Refers to the range of holders that connect with the corresponding inserts

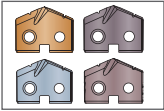

T-A Pro Carbide Inserts
Refers to ISO-material special coated carbide inserts that connect with the corresponding holders

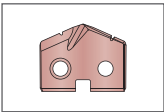

T-A Pro High-Speed Steel Inserts
Refers to HSS inserts that connect with the corresponding holders



Through coolant Option
Indicates that the product is coolant through

Series	Diameter Range	
	Metric (mm)	Imperial (inch)
Z	11.10mm - 12.69mm	0.437" - 0.499"
0	12.70mm - 17.64mm	0.500" - 0.694"
1	17.65mm - 24.37mm	0.695" - 0.959"
2	24.38mm - 35.04mm	0.960" - 1.379"
3	35.05mm - 47.80mm	1.380" - 1.882"

Introduction Information

Competitive Test Results	3
Case Studies	4 - 5
Insert Comparison and Assembly Information	6
T-A Pro Drilling System Information	7
Product Nomenclature	8 - 9

Z Series

Carbide Inserts	10
High-Speed Steel Inserts	11
Drill Holders	12 - 13

0 Series

Carbide Inserts	14 - 15
High-Speed Steel Inserts	16 - 17
Drill Holders	18 - 21

1 Series

Carbide Inserts	22 - 25
High-Speed Steel Inserts	26 - 29
Drill Holders	30 - 33

2 Series

Carbide Inserts	34 - 37
High-Speed Steel Inserts	38 - 41
Drill Holders	42 - 45

3 Series

Carbide Inserts	46 - 49
High-Speed Steel Inserts	50 - 53
Drill Holders	54 - 57

Recommended Cutting Data

Metric (mm)	Carbide	58 - 59
	High-Speed Steel	60 - 61
Imperial (inch)	Carbide	62 - 63
	High-Speed Steel	64 - 65

Tap Drill Information and Formulas

Metric (mm)	66
Imperial (inch)	67

Deep Hole Drilling Guidelines 68

Troubleshooting Guide 69

T-A Pro[®]

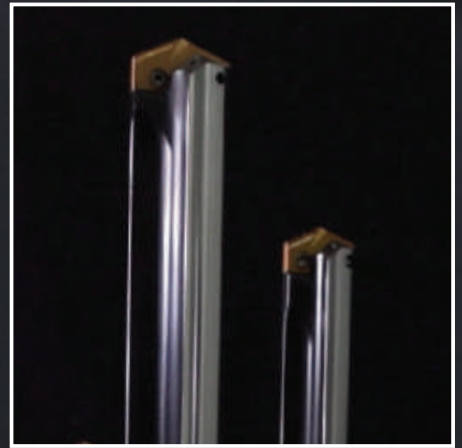

NEW HOLDER DESIGN

Optimized flute design for **increased** chip evacuation



NEW INSERT DESIGN

ISO-specific geometries with a new point design to **simplify** your insert choices



NEW COOLANT DESIGN

Proprietary coolant outlet configuration provides **superior** performance even in low coolant applications (15 BAR)

Competitive Test Results

T-A Pro®

TEST RESULTS



Average Tool Life
Test Results Drilling in 4340 Steel

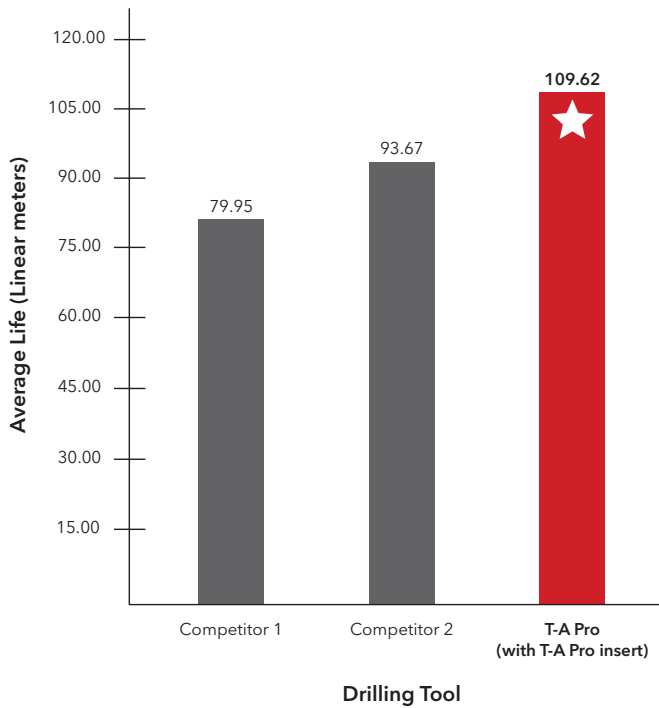

Project Profile: Competitive Testing in 4340 Steel
Tooling Solution: T-A Pro: Steel (P) Geometry with T-A Pro Holder

- The Parameters:**
- Hole Diameter = 14.30mm (0.5625")
 - Depth of Cut = 50.80mm (2")
 - Coolant = 300 PSI
 - Speed = 2546 RPM
 - Feed = 420 mm/min (16.55 inch/min)

The Results:
 When run at the listed parameters, here is how the 3 different tooling solutions performed:

Competitor 1 = 79.95 total linear meters
Competitor 2 = 93.67 total linear meters
T-A Pro = **109.62** total linear meters



Case Study

A
DRILLING

B
BORING

C
REAMING

D
URNISHING

E
HREADING

X
PECIALS

The Gift that Keeps Giving.

Not everything in life has to be a give and take. Our customer who machines fluid end frac blocks was previously having to reduce cutting parameters to achieve good chip formation and produce a successful part.



Needing better chip formation with a reduced cycle time, the customer tested Allied's **T-A Pro drill**. Using the "M" ISO-specific stainless steel insert geometry—developed for improved chip formation while minimizing exit burr—they were able to increase their speed and feed while maintaining ideal chip formation.

On top of the reduced cycle time, the T-A Pro had a increase tool life lowering the cost per hole by 58.82%. The success of the T-A Pro in this application is just another example of why the T-A Pro is more than just a good drill.

If you are looking for a solution that just keeps giving, **give us a call, and we will help you find the right solution.**

Product:	T-A Pro drill	Measure	Competitor Drill	T-A Pro Drill
Objective:	Reduce cycle time	RPM	480	545
Industry:	Oil & gas/ Petrochemical	Speed Rate	67.06 M/min (220 SFM)	76.20 M/min (250 SFM)
Part:	Fluid end frac block	Feed Rate	0.13 mm/rev (0.005 IPR)	0.20 mm/rev (0.008 IPR)
Material:	15-5 PH Stainless Steel	Penetration Rate	60.96 mm/min (2.4 IPM)	111.76 mm/min (4.4 IPM)
Hole Ø:	44.45 mm (1.75")	Total Part Cycle Time	500 sec	272 sec
Hole Depth:	508.00 mm (520.00")	Tool Life	30 holes	60 holes
Tolerance:	+/- 0.127 mm (0.005")	T-A Pro offered 58.82% cost per hole savings over the competitor tooling.		
Required Surface Finish:	3.2 µm (125 Ra µin)			

▶ T-A Pro holder
Item No. **HTA3D15-40FM**

▶ T-A Pro insert
M geometry (stainless steel)
Item No. **TAM3-44.45**

*45.60%
cycle time decrease*



The ISO-specific AM460 coated T-A Pro insert provided:

- ✓ Increased tool life
- ✓ Decreased cycle time
- ✓ Decreased cost per hole
- ✓ Increased penetration rate

Case Study

Need a solution with better tool life?

Our customer was machining engine block parts from ductile cast iron in a production cell. The replaceable tip drill they were using wasn't providing the results they needed, so they began searching for a tooling solution that would decrease machine downtime and increase productivity.

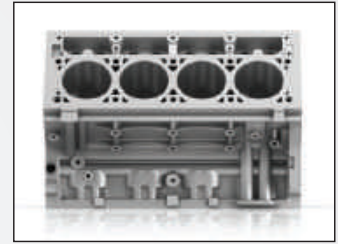

The customer tested the **T-A Pro® high penetration replaceable insert drill** using the "K" (cast iron) geometry insert with Allied's multilayer TiAlN coating that provides increased abrasion resistance and tool life. The T-A Pro performed better than the customer had hoped.

Using the T-A Pro not only provided substantial tool life improvements, but it also improved the penetration rate. The previous tooling had a tool life of 1700 holes, but the T-A Pro increased that life to 3400 holes. The T-A Pro also increased penetration rates by 30%. This allowed the customer to increase their productivity.

The bottom line: Our customer was able to achieve \$60k in tool savings per year with massive improvements in throughput. The advantage of the T-A Pro allowed our customer to achieve their tooling goals.

	Measure	Competitor Replaceable Insert Drill	T-A Pro Drill
Product: T-A Pro	RPM	1819 RPM	2092 RPM
Objectives: (1) Decrease machine downtime (2) Increase productivity	Speed	91 M/min (300 SFM)	105 M/min (345 SFM)
Industry: Automotive	Feed Rate	0.20 mm/rev (0.008 IPR)	0.23 mm/rev (0.0092 IPR)
Part: Engine block	Penetration Rate	369.57 mm/Min (14.55 IPM)	488.95 mm/Min (19.25 IPM)
Material: Ductile Cast Iron	Cycle Time	39 seconds	29 seconds
Hole Ø: 0.6299" (16.00mm)	Tool Life	1700 holes	3400 holes
Hole Depth: 9.50" (241.00mm)			

- ▶ T-A Pro Drill holder
15xD length
Item No. HTA0C15-20FM
- ▶ T-A Pro Drill inserts
K geometry
(cast iron)
Item No. TAK0-16.00

increased tool life by 100%









The cast iron TiAlN coated T-A Pro insert provided:

- ✓ **Doubled tool life**
- ✓ **Decreased machine downtime**
- ✓ **Increased productivity**
- ✓ **30% increased penetration rate**
- ✓ **Increased tool savings per year**

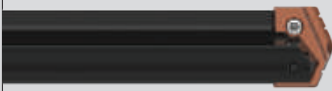

Insert Comparison and Assembly Information

				
		T-A Pro Inserts	T-A GEN2 Inserts	T-A Inserts
A				
DRILLING				
	Recommended for increased productivity		<input checked="" type="checkbox"/>	
B				
BORING				
	ISO-specific geometry/coating combination		<input checked="" type="checkbox"/>	
	Connects with T-A Pro holders		<input checked="" type="checkbox"/>	<input checked="" type="checkbox"/>
C				
REAMING				
	Connects with T-A holders		<input checked="" type="checkbox"/>	<input checked="" type="checkbox"/>

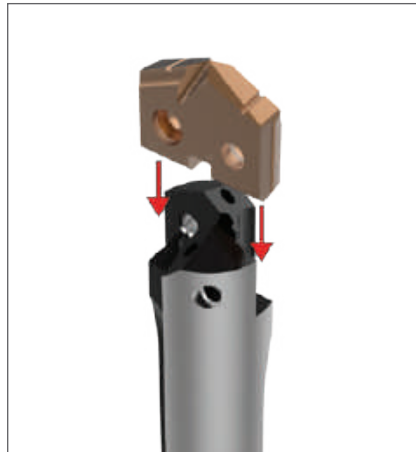

Step 1:
Align the flats on the T-A Pro insert with the flats on the ears of the holder.



Step 2:
Slide the insert into the precision ground locating pocket on the holder. The insert should not be turned, rotated, or twisted for locking purposes. The holder pocket and locating pads on the insert assure optimum fit and repeatability.

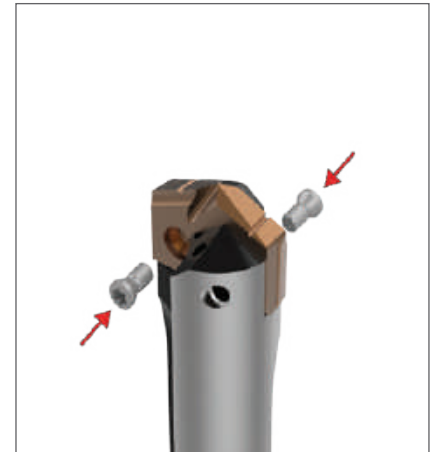

Step 3:
Apply a generous amount of E-Z Break® (provided in the packaging) onto the supplied TORX® Plus screws.

Tighten the TORX Plus screws to the recommended torque value specified in the catalog by series. A preset torx driver is available to assure that the proper torque is applied.

A
DRILLING
B
BORING
C
REAMING
D
BURNISHING
E
THREADING
X
SPECIALS

T-A Pro Drilling System Information



Advanced Design Capabilities

The advanced T-A Pro insert combines a coating and geometry specifically designed to achieve optimal results in ISO material drilling applications. With quick connectivity to existing T-A drill insert holders, the T-A Pro insert can be interchanged with previous T-A inserts with ease, resulting in minimal setup times so you can immediately increase your productivity.

T-A Pro Inserts Connect with:



T-A Pro holders

T-A holders

P - Steels

- Designed to provide increased penetration rates and tool life in steel applications
- Superior geometry and edge provides excellent chip control
- Allied's multilayer AM300 coating increases heat resistance and improves tool life

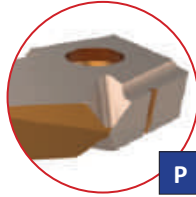

M - Stainless Steel

- Designed for all stainless steels and heat-resistant super alloys
- Geometry optimized for improved chip formation while minimizing exit burr
- Allied's new AM460 coating provides industry leading tool life in stainless and HRSA materials



K - Cast Irons

- Uniquely designed for cast/ductile iron applications
- Geometry developed for maximum tool life, reduced exit burr, and improved hole finish
- Allied's multilayer TiAlN coating provides increased abrasion resistance and tool life



X - High-Speed Steel Materials

- Improved chip geometry for excellent chip control in all materials
- Long tool life and high-process security for the most challenging applications
- Allied's multilayer AM200 coating combines excellent heat resistance and high lubricity for wide application use



N - Non-ferrous Materials

- Designed for applications in aluminum, brass, and copper
- The geometry yields excellent chip control in these softer materials
- TiCN coating gives the versatility to run in a variety of materials while reducing buildup

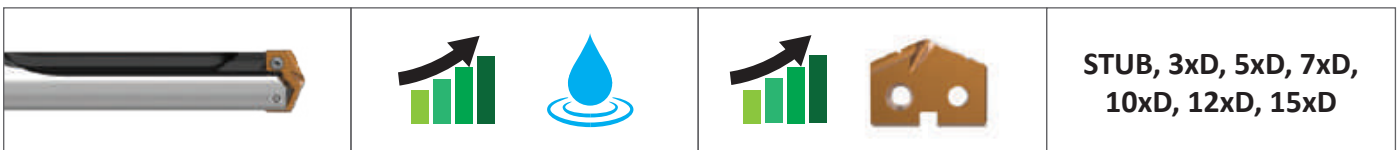
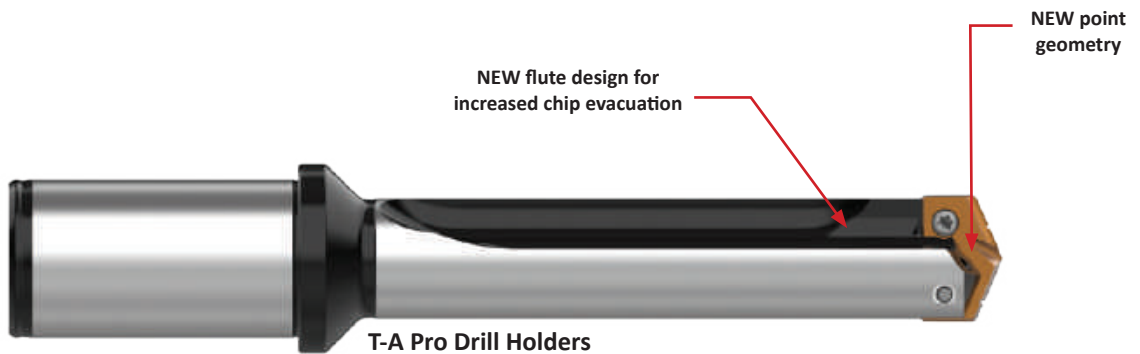

Straight flutes



Proprietary coolant outlets improve coolant flow



Provides increased insert life

**STUB, 3xD, 5xD, 7xD,
10xD, 12xD, 15xD**

Available in STUB, 3xD, 5xD, 7xD,
10xD, 12xD, and 15xD



Product Nomenclature

A
DRILLING
B
BORING
C
REAMING
D
BURNISHING
E
THREADING
X
SPECIALS

T-A Pro Drill Inserts

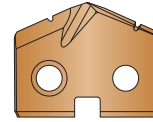

TA	P	0	-	15.00
1	2	3		4

1. T-A Pro Drill Insert	2. ISO Material / Geometry	3. Series	4. Diameter (mm)
TA = TA Pro insert	P = Steel K = Cast iron N = Non-ferrous M = Stainless Steel X = HSS	Z = Z series 0 = 0 series 1 = 1 series 2 = 2 series 3 = 3 series	For complete list of diameter ranges by series, see contents page.

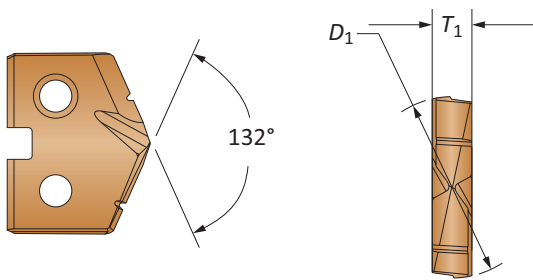

Reference Key

Symbol	Attribute
D_1	Insert diameter
T_1	Insert thickness

Product Nomenclature

T-A Pro Drill Holders

HTA	1	A	05	-	100	C
1	2	3	4		5	6

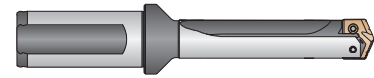

1. Holder HTA = TA Pro holder		2. Series Z = Z Series 0 = 0 Series 1 = 1 Series 2 = 2 Series 3 = 3 Series		3. Body Diameter A = A body diameter B = B body diameter C = C body diameter D = D body diameter		4. Length 01 = Stub Length 03 = 3x Diameter 05 = 5x Diameter 07 = 7x Diameter 10 = 10x Diameter 12 = 12x Diameter 15 = 15x Diameter	
5. Shank Diameter				6. Shank Style			
Metric (mm) 20 = 20mm 25 = 25mm 32 = 32mm 40 = 40mm		Imperial (inch) 075 = 3/4" 100 = 1" 125 = 1-1/4" 150 = 1-1/2"		F = Flanged with flat FM = Flanged metric with flat C = Cylindrical (no flat) CM = Cylindrical metric (no flat)			

Holder Ordering Information

The series designator (Z series, 0 series, etc.) in the top corner of each page is for your reference when ordering. Please refer to these series designators when placing an order. For example, a Z series drill insert only fits into a Z series holder.

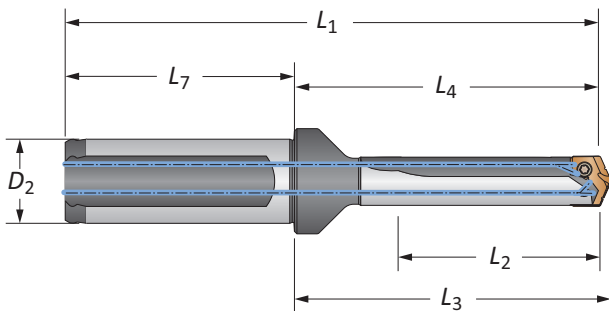

Reference Key





Symbol	Attribute
D_2	Shank diameter
L_1	Overall length
L_2	Drill depth
L_3	Holder reference length
L_4	Holder body length
L_7	Shank length

A
DRILLING
B
BORING
C
REAMING
D
BURNISHING
E
THREADING
X
SPECIALS

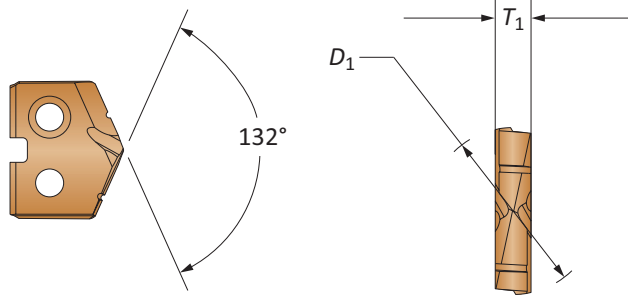
T-A Pro Carbide Drill Inserts

Z Series | Diameter Range: 11.10mm - 12.69mm (0.437" - 0.499")



Insert								
Series	D_1 mm	D_1 inch	Fractional Equivalent	T_1	Part No. P	Part No. K	Part No. N	Part No. M
Z-A	11.11	0.4374	7/16	3/32	TAPZ-11.11	TAKZ-11.11	TANZ-11.11	TAMZ-11.11
Z-A	11.20	0.4409		3/32	TAPZ-11.20	TAKZ-11.20	TANZ-11.20	TAMZ-11.20
Z-A	11.30	0.4449		3/32	TAPZ-11.30	TAKZ-11.30	TANZ-11.30	TAMZ-11.30
Z-A	11.40	0.4488		3/32	TAPZ-11.40	TAKZ-11.40	TANZ-11.40	TAMZ-11.40
Z-A	11.50	0.4528		3/32	TAPZ-11.50	TAKZ-11.50	TANZ-11.50	TAMZ-11.50
Z-A	11.51	0.4531	29/64	3/32	TAPZ-11.51	TAKZ-11.51	TANZ-11.51	TAMZ-11.51
Z-A	11.60	0.4567		3/32	TAPZ-11.60	TAKZ-11.60	TANZ-11.60	TAMZ-11.60
Z-A	11.70	0.4606		3/32	TAPZ-11.70	TAKZ-11.70	TANZ-11.70	TAMZ-11.70
Z-A	11.80	0.4646		3/32	TAPZ-11.80	TAKZ-11.80	TANZ-11.80	TAMZ-11.80
Z-A	11.91	0.4689	15/32	3/32	TAPZ-11.91	TAKZ-11.91	TANZ-11.91	TAMZ-11.91
Z-A	12.00	0.4724		3/32	TAPZ-12.00	TAKZ-12.00	TANZ-12.00	TAMZ-12.00
Z-A	12.10	0.4764		3/32	TAPZ-12.10	TAKZ-12.10	TANZ-12.10	TAMZ-12.10
Z-B	12.20	0.4803		3/32	TAPZ-12.20	TAKZ-12.20	TANZ-12.20	TAMZ-12.20
Z-B	12.30	0.4843	31/64	3/32	TAPZ-12.30	TAKZ-12.30	TANZ-12.30	TAMZ-12.30
Z-B	12.40	0.4882		3/32	TAPZ-12.40	TAKZ-12.40	TANZ-12.40	TAMZ-12.40
Z-B	12.50	0.4921		3/32	TAPZ-12.50	TAKZ-12.50	TANZ-12.50	TAMZ-12.50
Z-B	12.60	0.4961		3/32	TAPZ-12.60	TAKZ-12.60	TANZ-12.60	TAMZ-12.60

Inserts sold in multiples of 2

Sub Series Holders (A, B, C, D)

Sub series holders are recommended when running carbide inserts toward the upper end of the series drill range, as well as in tougher applications requiring more insert support and holder strength. **NOTE:** Only specified sub series inserts should be used with equivalent or smaller sub series holders.



A Series Insert +
A Series Holder



C Series Insert +
A Series Holder



C Series Insert +
C Series Holder



A Series Insert +
C Series Holder

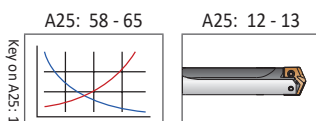

Sizes not shown are available upon request.

When ordering, please follow the example below:

Metric:	13.16mm, Steel, 0 series = use Part No. TAP0-13.16
Imperial:	0.5180", Steel, 0 series = use Part No. TAP0-13.16

T-A Pro HSS Drill Inserts

Z Series | Diameter Range: 11.10mm - 12.69mm (0.437" - 0.499")

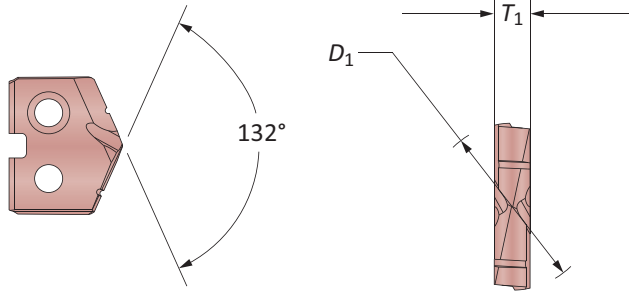

Insert					
Series	D ₁ mm	D ₁ inch	Fractional Equivalent	T ₁	Part No.
Z-A	11.11	0.4374	7/16	3/32	TAXZ-11.11
Z-A	11.20	0.4409		3/32	TAXZ-11.20
Z-A	11.30	0.4449		3/32	TAXZ-11.30
Z-A	11.40	0.4488		3/32	TAXZ-11.40
Z-A	11.50	0.4528		3/32	TAXZ-11.50
Z-A	11.51	0.4531	29/64	3/32	TAXZ-11.51
Z-A	11.60	0.4567		3/32	TAXZ-11.60
Z-A	11.70	0.4606		3/32	TAXZ-11.70
Z-A	11.80	0.4646		3/32	TAXZ-11.80
Z-A	11.91	0.4689	15/32	3/32	TAXZ-11.91
Z-A	12.00	0.4724		3/32	TAXZ-12.00
Z-A	12.10	0.4764		3/32	TAXZ-12.10
Z-B	12.20	0.4803		3/32	TAXZ-12.20
Z-B	12.30	0.4843	31/64	3/32	TAXZ-12.30
Z-B	12.40	0.4882		3/32	TAXZ-12.40
Z-B	12.50	0.4921		3/32	TAXZ-12.50
Z-B	12.60	0.4961		3/32	TAXZ-12.60

Inserts sold in multiples of 2

A

DRILLING

B

BORING

C

REAMING

D

BURNISHING

F

THREADING

X

SPECIALS

Sub Series Holders (A, B, C, D)

Sub series holders are recommended when running carbide inserts toward the upper end of the series drill range, as well as in tougher applications requiring more insert support and holder strength. **NOTE:** Only specified sub series inserts should be used with equivalent or smaller sub series holders.



A Series Insert +
A Series Holder



C Series Insert +
A Series Holder



C Series Insert +
C Series Holder



A Series Insert +
C Series Holder

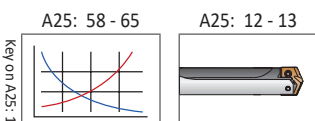

Sizes not shown are available upon request. When ordering, please follow the example below:	
Metric:	13.16mm, Steel, 0 series = use Part No. TAP0-13.16
Imperial:	0.5180", Steel, 0 series = use Part No. TAP0-13.16

T-A Pro Drill Holders

Z Series Metric | Diameter Range: 11.10mm - 12.69mm

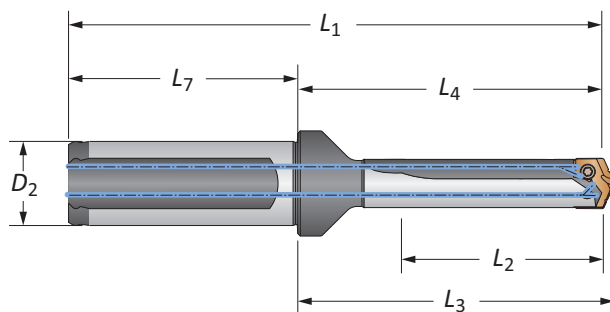

		Body				Shank				
Length	Sub Series	L ₂	L ₄	L ₃	L ₁	L ₇	D ₂	Flat	Part No	
STUB	A	12.8	40.7	43.4	90.7	50	20	Yes	HTAZA01-20FM	
STUB	A	12.8	40.7	43.4	90.7	50	20	No	HTAZA01-20CM	
STUB	B	12.8	40.7	43.4	90.7	50	20	Yes	HTAZB01-20FM	
STUB	B	12.8	40.7	43.4	90.7	50	20	No	HTAZB01-20CM	
3xD	A	36.9	68.4	71.2	118.4	50	20	Yes	HTAZA03-20FM	
3xD	A	36.9	68.4	71.2	118.4	50	20	No	HTAZA03-20CM	
3xD	B	36.9	68.4	71.2	118.4	50	20	Yes	HTAZB03-20FM	
3xD	B	36.9	68.4	71.2	118.4	50	20	No	HTAZB03-20CM	
5xD	A	61.0	92.5	95.3	142.5	50	20	Yes	HTAZA05-20FM	
5xD	A	61.0	92.5	95.3	142.5	50	20	No	HTAZA05-20CM	
5xD	B	61.0	92.5	95.3	142.5	50	20	Yes	HTAZB05-20FM	
5xD	B	61.0	92.5	95.3	142.5	50	20	No	HTAZB05-20CM	
7xD	A	85.0	116.5	119.3	166.6	50	20	Yes	HTAZA07-20FM	
7xD	A	85.0	116.5	119.3	166.6	50	20	No	HTAZA07-20CM	
7xD	B	85.0	116.5	119.3	166.6	50	20	Yes	HTAZB07-20FM	
7xD	B	85.0	116.5	119.3	166.6	50	20	No	HTAZB07-20CM	
10xD	A	121.2	152.7	155.5	202.7	50	20	Yes	HTAZA10-20FM	
10xD	A	121.2	152.7	155.5	202.7	50	20	No	HTAZA10-20CM	
10xD	B	121.2	152.7	155.5	202.7	50	20	Yes	HTAZB10-20FM	
10xD	B	121.2	152.7	155.5	202.7	50	20	No	HTAZB10-20CM	
12xD	A	145.2	176.7	179.5	226.8	50	20	Yes	HTAZA12-20FM	
12xD	A	145.2	176.7	179.5	226.8	50	20	No	HTAZA12-20CM	
12xD	B	145.2	176.7	179.5	226.8	50	20	Yes	HTAZB12-20FM	
12xD	B	145.2	176.7	179.5	226.8	50	20	No	HTAZB12-20CM	
15xD	A	181.4	212.9	215.7	262.9	50	20	Yes	HTAZA15-20FM	
15xD	A	181.4	212.9	215.7	262.9	50	20	No	HTAZA15-20CM	
15xD	B	181.4	212.9	215.7	262.9	50	20	Yes	HTAZB15-20FM	
15xD	B	181.4	212.9	215.7	262.9	50	20	No	HTAZB15-20CM	

Connection Accessories

Insert Screws	Nylon Locking Screws	Insert Driver	Preset Torque Hand Driver	Replacement Tips	Admissible Tightening Torque*
7247-IP7-1	7247N-IP7-1	8IP-7	8IP-7TL	8IP-7B	84 N-cm (7.4 in-lbs)

*Tightening torques are calculated with a friction coefficient of $\mu = 0.14$ and develop 90% of ultimate yield strength

WARNING Refer to Speed and Feed charts for recommended adjustments to speeds and feeds. Refer to page A25: 68 for deep hole drilling guidelines in this section of the catalog. Visit www.alliedmachine.com/DeepHoleGuidelines for the most up-to-date information and procedures. Factory technical assistance is available for your specific applications through our Application Engineering department.
email: engineering.eu@alliedmachine.com

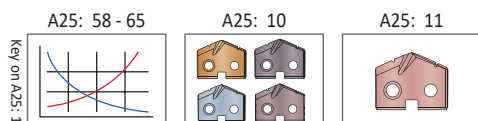









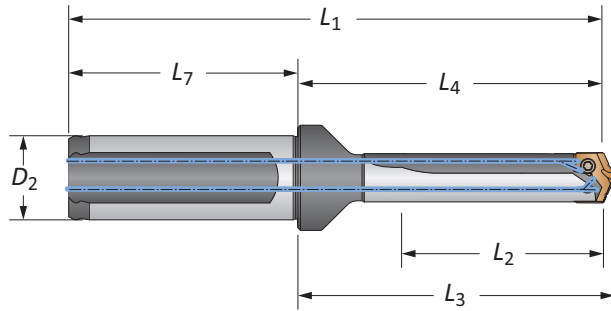



mm = Metric (mm)
 in = Imperial (in)

Screws sold in multiples of 10





T-A Pro Drill Holders

Z Series Imperial | Diameter Range: 0.437" - 0.499"

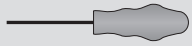

		Body				Shank				
Length	Sub Series	L ₂	L ₄	L ₃	L ₁	L ₇	D ₂	Flat	Part No	
STUB	A	0.504	1.600	1.710	3.630	2.03	3/4	Yes	HTAZA01-075F	
STUB	A	0.504	1.600	1.710	3.630	2.03	3/4	No	HTAZA01-075C	
STUB	B	0.504	1.600	1.710	3.630	2.03	3/4	Yes	HTAZB01-075F	
STUB	B	0.504	1.600	1.710	3.630	2.03	3/4	No	HTAZB01-075C	
3xD	A	1.452	2.693	2.803	4.723	2.03	3/4	Yes	HTAZA03-075F	
3xD	A	1.452	2.693	2.803	4.723	2.03	3/4	No	HTAZA03-075C	
3xD	B	1.452	2.693	2.803	4.723	2.03	3/4	Yes	HTAZB03-075F	
3xD	B	1.452	2.693	2.803	4.723	2.03	3/4	No	HTAZB03-075C	
5xD	A	2.400	3.641	3.751	5.671	2.03	3/4	Yes	HTAZA05-075F	
5xD	A	2.400	3.641	3.751	5.671	2.03	3/4	No	HTAZA05-075C	
5xD	B	2.400	3.641	3.751	5.671	2.03	3/4	Yes	HTAZB05-075F	
5xD	B	2.400	3.641	3.751	5.671	2.03	3/4	No	HTAZB05-075C	
7xD	A	3.348	4.589	4.699	6.619	2.03	3/4	Yes	HTAZA07-075F	
7xD	A	3.348	4.589	4.699	6.619	2.03	3/4	No	HTAZA07-075C	
7xD	B	3.348	4.589	4.699	6.619	2.03	3/4	Yes	HTAZB07-075F	
7xD	B	3.348	4.589	4.699	6.619	2.03	3/4	No	HTAZB07-075C	
10xD	A	4.770	6.011	6.121	8.041	2.03	3/4	Yes	 HTAZA10-075F	
10xD	A	4.770	6.011	6.121	8.041	2.03	3/4	No	 HTAZA10-075C	
10xD	B	4.770	6.011	6.121	8.041	2.03	3/4	Yes	 HTAZB10-075F	
10xD	B	4.770	6.011	6.121	8.041	2.03	3/4	No	 HTAZB10-075C	
12xD	A	5.718	6.959	7.069	8.989	2.03	3/4	Yes	 HTAZA12-075F	
12xD	A	5.718	6.959	7.069	8.989	2.03	3/4	No	 HTAZA12-075C	
12xD	B	5.718	6.959	7.069	8.989	2.03	3/4	Yes	 HTAZB12-075F	
12xD	B	5.718	6.959	7.069	8.989	2.03	3/4	No	 HTAZB12-075C	
15xD	A	7.140	8.381	8.491	10.411	2.03	3/4	Yes	 HTAZA15-075F	
15xD	A	7.140	8.381	8.491	10.411	2.03	3/4	No	 HTAZA15-075C	
15xD	B	7.140	8.381	8.491	10.411	2.03	3/4	Yes	 HTAZB15-075F	
15xD	B	7.140	8.381	8.491	10.411	2.03	3/4	No	 HTAZB15-075C	

Connection Accessories

 Insert Screws	 Nylon Locking Screws	 Insert Driver	 Preset Torque Hand Driver	 Replacement Tips	Admissible Tightening Torque*
7247-IP7-1	7247N-IP7-1	8IP-7	8IP-7TL	8IP-7B	84 N-cm (7.4 in-lbs)

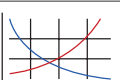

*Tightening torques are calculated with a friction coefficient of $\mu = 0.14$ and develop 90% of ultimate yield strength

1. WARNING Refer to Speed and Feed charts for recommended adjustments to speeds and feeds. Refer to page A25: 68 for deep hole drilling guidelines in this section of the catalog. Visit www.alliedmachine.com/DeepHoleGuidelines for the most up-to-date information and procedures. Factory technical assistance is available for your specific applications through our Application Engineering department.
email: engineering.eu@alliedmachine.com

A25: 58 - 65  Key on A25: 1

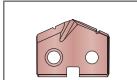
A25: 10 

A25: 11 





 = Metric (mm)
 = Imperial (in)
 Screws sold in multiples of 10

Z
A DRILLING
B BORING
C REAMING
D BURNISHING
E THREADING
X SPECIALS

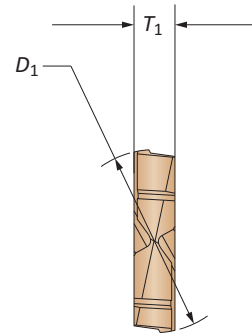
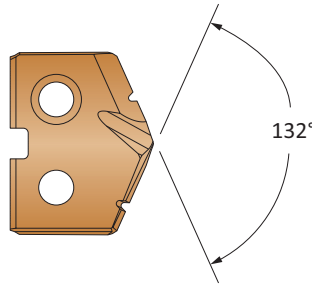
T-A Pro Carbide Drill Inserts

0 Series | Diameter Range: 12.70mm - 17.64mm (0.500" - 0.694")



Insert								
Series	D ₁ mm	D ₁ inch	Fractional Equivalent	T ₁	Part No. P	Part No. K	Part No. N	Part No. M
0-A	12.70	0.5000	1/2	1/8	TAP0-12.70	TAK0-12.70	TAN0-12.70	TAM0-12.70
0-A	12.80	0.5039		1/8	TAP0-12.80	TAK0-12.80	TAN0-12.80	TAM0-12.80
0-A	12.90	0.5079		1/8	TAP0-12.90	TAK0-12.90	TAN0-12.90	TAM0-12.90
0-A	13.00	0.5118		1/8	TAP0-13.00	TAK0-13.00	TAN0-13.00	TAM0-13.00
0-A	13.10	0.5157	33/64	1/8	TAP0-13.10	TAK0-13.10	TAN0-13.10	TAM0-13.10
0-A	13.20	0.5197		1/8	TAP0-13.20	TAK0-13.20	TAN0-13.20	TAM0-13.20
0-A	13.30	0.5236		1/8	TAP0-13.30	TAK0-13.30	TAN0-13.30	TAM0-13.30
0-A	13.40	0.5276		1/8	TAP0-13.40	TAK0-13.40	TAN0-13.40	TAM0-13.40
0-A	13.49	0.5311	17/32	1/8	TAP0-13.49	TAK0-13.49	TAN0-13.49	TAM0-13.49
0-A	13.50	0.5315		1/8	TAP0-13.50	TAK0-13.50	TAN0-13.50	TAM0-13.50
0-A	13.60	0.5354		1/8	TAP0-13.60	TAK0-13.60	TAN0-13.60	TAM0-13.60
0-A	13.70	0.5394		1/8	TAP0-13.70	TAK0-13.70	TAN0-13.70	TAM0-13.70
0-A	13.80	0.5433		1/8	TAP0-13.80	TAK0-13.80	TAN0-13.80	TAM0-13.80
0-A	13.89	0.5469	35/64	1/8	TAP0-13.89	TAK0-13.89	TAN0-13.89	TAM0-13.89
0-B	14.00	0.5512		1/8	TAP0-14.00	TAK0-14.00	TAN0-14.00	TAM0-14.00
0-B	14.10	0.5551		1/8	TAP0-14.10	TAK0-14.10	TAN0-14.10	TAM0-14.10
0-B	14.20	0.5591		1/8	TAP0-14.20	TAK0-14.20	TAN0-14.20	TAM0-14.20
0-B	14.29	0.5626	9/16	1/8	TAP0-14.29	TAK0-14.29	TAN0-14.29	TAM0-14.29
0-B	14.40	0.5669		1/8	TAP0-14.40	TAK0-14.40	TAN0-14.40	TAM0-14.40
0-B	14.50	0.5709		1/8	TAP0-14.50	TAK0-14.50	TAN0-14.50	TAM0-14.50
0-B	14.60	0.5748		1/8	TAP0-14.60	TAK0-14.60	TAN0-14.60	TAM0-14.60
0-B	14.68	0.5780	37/64	1/8	TAP0-14.68	TAK0-14.68	TAN0-14.68	TAM0-14.68
0-B	14.80	0.5827		1/8	TAP0-14.80	TAK0-14.80	TAN0-14.80	TAM0-14.80
0-B	14.90	0.5866		1/8	TAP0-14.90	TAK0-14.90	TAN0-14.90	TAM0-14.90
0-B	15.00	0.5906		1/8	TAP0-15.00	TAK0-15.00	TAN0-15.00	TAM0-15.00

Inserts sold in multiples of 2

Sub Series Holders (A, B, C, D)

Sub series holders are recommended when running carbide inserts toward the upper end of the series drill range, as well as in tougher applications requiring more insert support and holder strength. **NOTE:** Only specified sub series inserts should be used with equivalent or smaller sub series holders.



A Series Insert +
A Series Holder



C Series Insert +
A Series Holder



C Series Insert +
C Series Holder



A Series Insert +
C Series Holder

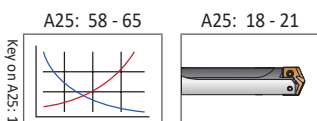



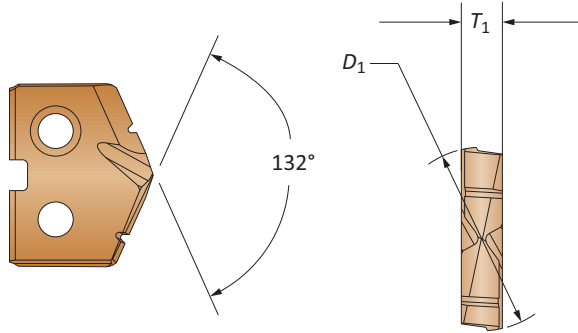

Sizes not shown are available upon request.	
When ordering, please follow the example below:	
Metric:	13.16mm, Steel, 0 series = use Part No. TAP0-13.16
Imperial:	0.5180", Steel, 0 series = use Part No. TAP0-13.16

T-A Pro Carbide Drill Inserts

0 Series | Diameter Range: 12.70mm - 17.64mm (0.500" - 0.694")



Insert								
Series	D ₁ mm	D ₁ inch	Fractional Equivalent	T ₁	Part No. P	Part No. K	Part No. N	Part No. M
0-C	15.08	0.5937	19/32	1/8	TAP0-15.08	TAK0-15.08	TAN0-15.08	TAM0-15.08
0-C	15.20	0.5984		1/8	TAP0-15.20	TAK0-15.20	TAN0-15.20	TAM0-15.20
0-C	15.25	0.6004		1/8	TAP0-15.25	TAK0-15.25	TAN0-15.25	TAM0-15.25
0-C	15.30	0.6024		1/8	TAP0-15.30	TAK0-15.30	TAN0-15.30	TAM0-15.30
0-C	15.40	0.6063		1/8	TAP0-15.40	TAK0-15.40	TAN0-15.40	TAM0-15.40
0-C	15.48	0.6094	39/64	1/8	TAP0-15.48	TAK0-15.48	TAN0-15.48	TAM0-15.48
0-C	15.50	0.6102		1/8	TAP0-15.50	TAK0-15.50	TAN0-15.50	TAM0-15.50
0-C	15.60	0.6142		1/8	TAP0-15.60	TAK0-15.60	TAN0-15.60	TAM0-15.60
0-C	15.70	0.6181		1/8	TAP0-15.70	TAK0-15.70	TAN0-15.70	TAM0-15.70
0-C	15.80	0.6220		1/8	TAP0-15.80	TAK0-15.80	TAN0-15.80	TAM0-15.80
0-C	15.88	0.6252	5/8	1/8	TAP0-15.88	TAK0-15.88	TAN0-15.88	TAM0-15.88
0-C	16.00	0.6299		1/8	TAP0-16.00	TAK0-16.00	TAN0-16.00	TAM0-16.00
0-C	16.08	0.6331		1/8	TAP0-16.08	TAK0-16.08	TAN0-16.08	TAM0-16.08
0-C	16.20	0.6378		1/8	TAP0-16.20	TAK0-16.20	TAN0-16.20	TAM0-16.20
0-C	16.27	0.6406	41/64	1/8	TAP0-16.27	TAK0-16.27	TAN0-16.27	TAM0-16.27
0-C	16.40	0.6457		1/8	TAP0-16.40	TAK0-16.40	TAN0-16.40	TAM0-16.40
0-D	16.50	0.6496		1/8	TAP0-16.50	TAK0-16.50	TAN0-16.50	TAM0-16.50
0-D	16.60	0.6535		1/8	TAP0-16.60	TAK0-16.60	TAN0-16.60	TAM0-16.60
0-D	16.67	0.6563	21/32	1/8	TAP0-16.67	TAK0-16.67	TAN0-16.67	TAM0-16.67
0-D	16.80	0.6614		1/8	TAP0-16.80	TAK0-16.80	TAN0-16.80	TAM0-16.80
0-D	16.90	0.6654		1/8	TAP0-16.90	TAK0-16.90	TAN0-16.90	TAM0-16.90
0-D	17.00	0.6693		1/8	TAP0-17.00	TAK0-17.00	TAN0-17.00	TAM0-17.00
0-D	17.07	0.6720	43/64	1/8	TAP0-17.07	TAK0-17.07	TAN0-17.07	TAM0-17.07
0-D	17.10	0.6732		1/8	TAP0-17.10	TAK0-17.10	TAN0-17.10	TAM0-17.10
0-D	17.20	0.6772		1/8	TAP0-17.20	TAK0-17.20	TAN0-17.20	TAM0-17.20
0-D	17.30	0.6811		1/8	TAP0-17.30	TAK0-17.30	TAN0-17.30	TAM0-17.30
0-D	17.40	0.6850		1/8	TAP0-17.40	TAK0-17.40	TAN0-17.40	TAM0-17.40
0-D	17.46	0.6874	11/16	1/8	TAP0-17.46	TAK0-17.46	TAN0-17.46	TAM0-17.46
0-D	17.50	0.6890		1/8	TAP0-17.50	TAK0-17.50	TAN0-17.50	TAM0-17.50
0-D	17.60	0.6929		1/8	TAP0-17.60	TAK0-17.60	TAN0-17.60	TAM0-17.60

Inserts sold in multiples of 2

Sub Series Holders (A, B, C, D)

Sub series holders are recommended when running carbide inserts toward the upper end of the series drill range, as well as in tougher applications requiring more insert support and holder strength. **NOTE:** Only specified sub series inserts should be used with equivalent or smaller sub series holders.



A Series Insert +
A Series Holder



C Series Insert +
A Series Holder



C Series Insert +
C Series Holder



A Series Insert +
C Series Holder

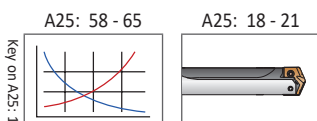

Sizes not shown are available upon request. When ordering, please follow the example below:	
Metric:	13.16mm, Steel, 0 series = use Part No. TAP0-13.16
Imperial:	0.5180", Steel, 0 series = use Part No. TAP0-13.16

T-A Pro HSS Drill Inserts

0 Series | Diameter Range: 12.70mm - 17.64mm (0.500" - 0.694")

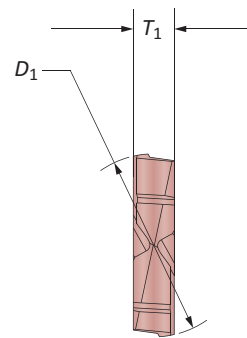
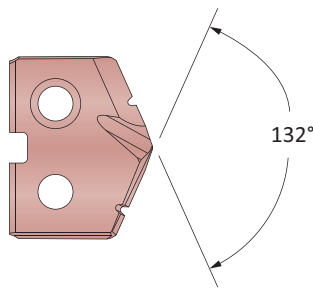

Series	D ₁ mm	D ₁ inch	Fractional Equivalent	T ₁	Insert
					Part No.
0-A	12.70	0.5000	1/2	1/8	TAX0-12.70
0-A	12.80	0.5039		1/8	TAX0-12.80
0-A	12.90	0.5079		1/8	TAX0-12.90
0-A	13.00	0.5118		1/8	TAX0-13.00
0-A	13.10	0.5157	33/64	1/8	TAX0-13.10
0-A	13.20	0.5197		1/8	TAX0-13.20
0-A	13.30	0.5236		1/8	TAX0-13.30
0-A	13.40	0.5276		1/8	TAX0-13.40
0-A	13.49	0.5311	17/32	1/8	TAX0-13.49
0-A	13.50	0.5315		1/8	TAX0-13.50
0-A	13.60	0.5354		1/8	TAX0-13.60
0-A	13.70	0.5394		1/8	TAX0-13.70
0-A	13.80	0.5433		1/8	TAX0-13.80
0-A	13.89	0.5469	35/64	1/8	TAX0-13.89
0-B	14.00	0.5512		1/8	TAX0-14.00
0-B	14.10	0.5551		1/8	TAX0-14.10
0-B	14.20	0.5591		1/8	TAX0-14.20
0-B	14.29	0.5626	9/16	1/8	TAX0-14.29
0-B	14.40	0.5669		1/8	TAX0-14.40
0-B	14.50	0.5709		1/8	TAX0-14.50
0-B	14.60	0.5748		1/8	TAX0-14.60
0-B	14.68	0.5780	37/64	1/8	TAX0-14.68
0-B	14.80	0.5827		1/8	TAX0-14.80
0-B	14.90	0.5866		1/8	TAX0-14.90
0-B	15.00	0.5906		1/8	TAX0-15.00

Inserts sold in multiples of 2

Sub Series Holders (A, B, C, D)

Sub series holders are recommended when running carbide inserts toward the upper end of the series drill range, as well as in tougher applications requiring more insert support and holder strength. **NOTE:** Only specified sub series inserts should be used with equivalent or smaller sub series holders.



A Series Insert +
A Series Holder



C Series Insert +
A Series Holder



C Series Insert +
C Series Holder



A Series Insert +
C Series Holder

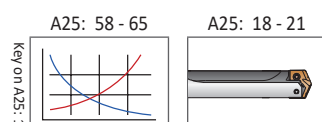



Sizes not shown are available upon request.
When ordering, please follow the example below:

Metric:	13.16mm, Steel, 0 series = use Part No. TAP0-13.16
Imperial:	0.5180", Steel, 0 series = use Part No. TAP0-13.16

T-A Pro HSS Drill Inserts

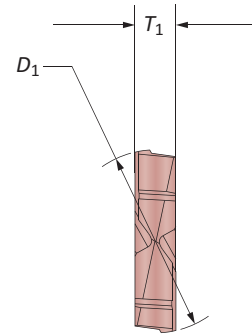
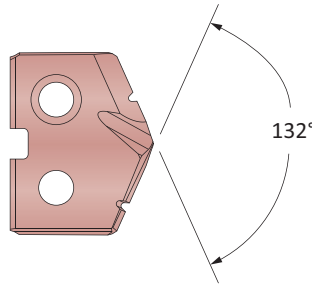
0 Series | Diameter Range: 12.70mm - 17.64mm (0.500" - 0.694")



Series	D ₁ mm	D ₁ inch	Fractional Equivalent	T ₁	
					Part No.
0-C	15.08	0.5937	19/32	1/8	TAX0-15.08
0-C	15.20	0.5984		1/8	TAX0-15.20
0-C	15.25	0.6004		1/8	TAX0-15.25
0-C	15.30	0.6024		1/8	TAX0-15.30
0-C	15.40	0.6063		1/8	TAX0-15.40
0-C	15.48	0.6094	39/64	1/8	TAX0-15.48
0-C	15.50	0.6102		1/8	TAX0-15.50
0-C	15.60	0.6142		1/8	TAX0-15.60
0-C	15.70	0.6181		1/8	TAX0-15.70
0-C	15.80	0.6220		1/8	TAX0-15.80
0-C	15.88	0.6252	5/8	1/8	TAX0-15.88
0-C	16.00	0.6299		1/8	TAX0-16.00
0-C	16.08	0.6331		1/8	TAX0-16.08
0-C	16.20	0.6378		1/8	TAX0-16.20
0-C	16.27	0.6406	41/64	1/8	TAX0-16.27
0-C	16.40	0.6457		1/8	TAX0-16.40
0-D	16.50	0.6496		1/8	TAX0-16.50
0-D	16.60	0.6535		1/8	TAX0-16.60
0-D	16.67	0.6563	21/32	1/8	TAX0-16.67
0-D	16.80	0.6614		1/8	TAX0-16.80
0-D	16.90	0.6654		1/8	TAX0-16.90
0-D	17.00	0.6693		1/8	TAX0-17.00
0-D	17.07	0.6720	43/64	1/8	TAX0-17.07
0-D	17.10	0.6732		1/8	TAX0-17.10
0-D	17.20	0.6772		1/8	TAX0-17.20
0-D	17.30	0.6811		1/8	TAX0-17.30
0-D	17.40	0.6850		1/8	TAX0-17.40
0-D	17.46	0.6874	11/16	1/8	TAX0-17.46
0-D	17.50	0.6890		1/8	TAX0-17.50
0-D	17.60	0.6929		1/8	TAX0-17.60

Inserts sold in multiples of 2

Sub Series Holders (A, B, C, D)

Sub series holders are recommended when running carbide inserts toward the upper end of the series drill range, as well as in tougher applications requiring more insert support and holder strength. **NOTE:** Only specified sub series inserts should be used with equivalent or smaller sub series holders.



A Series Insert +
A Series Holder



C Series Insert +
A Series Holder



C Series Insert +
C Series Holder



A Series Insert +
C Series Holder

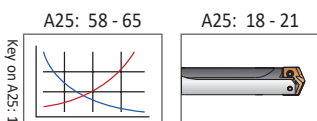

Sizes not shown are available upon request.	
When ordering, please follow the example below:	
Metric:	13.16mm, Steel, 0 series = use Part No. TAP0-13.16
Imperial:	0.5180", Steel, 0 series = use Part No. TAP0-13.16

A
DRILLING
B
BORING
C
REAMING
D
BURISHING
E
THREADING
X
SPECIALS

T-A Pro Drill Holders

0 Series Metric | Diameter Range: 12.70mm - 17.64mm

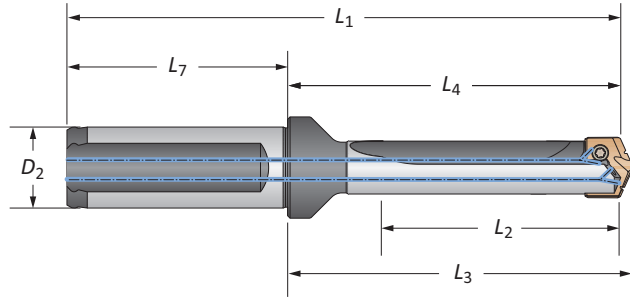

		Body				Shank				
Length	Sub Series	L ₂	L ₄	L ₃	L ₁	L ₇	D ₂	Flat	Part No	
STUB	A	15.3	44.0	46.7	95.5	51.6	20	Yes	HTA0A01-20FM	
STUB	A	15.3	44.0	46.7	95.5	51.6	20	No	HTA0A01-20CM	
STUB	B	15.3	44.0	46.7	95.5	51.6	20	Yes	HTA0B01-20FM	
STUB	B	15.3	44.0	46.7	95.5	51.6	20	No	HTA0B01-20CM	
STUB	C	15.3	44.0	46.7	95.5	51.6	20	Yes	HTA0C01-20FM	
STUB	C	15.3	44.0	46.7	95.5	51.6	20	No	HTA0C01-20CM	
STUB	D	15.3	44.0	46.7	95.5	51.6	20	Yes	HTA0D01-20FM	
STUB	D	15.3	44.0	46.7	95.5	51.6	20	No	HTA0D01-20CM	
3xD	A	45.9	77.8	80.5	129.4	51.6	20	Yes	HTA0A03-20FM	
3xD	A	45.9	77.8	80.5	129.4	51.6	20	No	HTA0A03-20CM	
3xD	B	45.9	77.8	80.5	129.4	51.6	20	Yes	HTA0B03-20FM	
3xD	B	45.9	77.8	80.5	129.4	51.6	20	No	HTA0B03-20CM	
3xD	C	45.9	77.8	80.5	129.4	51.6	20	Yes	HTA0C03-20FM	
3xD	C	45.9	77.8	80.5	129.4	51.6	20	No	HTA0C03-20CM	
3xD	D	45.9	77.8	80.5	129.4	51.6	20	Yes	HTA0D03-20FM	
3xD	D	45.9	77.8	80.5	129.4	51.6	20	No	HTA0D03-20CM	
5xD	A	76.6	108.5	111.2	160.0	51.6	20	Yes	HTA0A05-20FM	
5xD	A	76.6	108.5	111.2	160.0	51.6	20	No	HTA0A05-20CM	
5xD	B	76.6	108.5	111.2	160.0	51.6	20	Yes	HTA0B05-20FM	
5xD	B	76.6	108.5	111.2	160.0	51.6	20	No	HTA0B05-20CM	
5xD	C	76.6	108.5	111.2	160.0	51.6	20	Yes	HTA0C05-20FM	
5xD	C	76.6	108.5	111.2	160.0	51.6	20	No	HTA0C05-20CM	
5xD	D	76.6	108.5	111.2	160.0	51.6	20	Yes	HTA0D05-20FM	
5xD	D	76.6	108.5	111.2	160.0	51.6	20	No	HTA0D05-20CM	
7xD	A	107.2	139.1	141.8	190.7	51.6	20	Yes	HTA0A07-20FM	
7xD	A	107.2	139.1	141.8	190.7	51.6	20	No	HTA0A07-20CM	
7xD	B	107.2	139.1	141.8	190.7	51.6	20	Yes	HTA0B07-20FM	
7xD	B	107.2	139.1	141.8	190.7	51.6	20	No	HTA0B07-20CM	
7xD	C	107.2	139.1	141.8	190.7	51.6	20	Yes	HTA0C07-20FM	
7xD	C	107.2	139.1	141.8	190.7	51.6	20	No	HTA0C07-20CM	
7xD	D	107.2	139.1	141.8	190.7	51.6	20	Yes	HTA0D07-20FM	
7xD	D	107.2	139.1	141.8	190.7	51.6	20	No	HTA0D07-20CM	

Connection Accessories

	Insert Screws	Nylon Locking Screws	Insert Driver	Preset Torque Hand Driver	Replacement Tips	Admissible Tightening Torque*
A/B	72556-IP8-1	72556N-IP8-1	8IP-8	8IP-8TL	8IP-8B	175 N-cm (15.5 in-lbs)
C/D	72567-IP8-1	72567N-IP8-1	8IP-8	8IP-8TL	8IP-8B	175 N-cm (15.5 in-lbs)

*Tightening torques are calculated with a friction coefficient of $\mu = 0.14$ and develop 90% of ultimate yield strength

1. WARNING Refer to Speed and Feed charts for recommended adjustments to speeds and feeds. Refer to page A25: 68 for deep hole drilling guidelines in this section of the catalog. Visit www.alliedmachine.com/DeepHoleGuidelines for the most up-to-date information and procedures. Factory technical assistance is available for your specific applications through our Application Engineering department.
email: engineering.eu@alliedmachine.com

A25: 58 - 65 Key on A25: 1

A25: 14 - 15

A25: 16 - 17









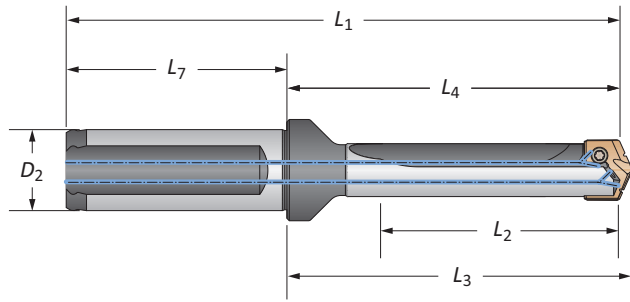















Ⓜ = Metric (mm)
Ⓜ = Imperial (in)

Screws sold in multiples of 10





T-A Pro Drill Holders

0 Series Metric | Diameter Range: 12.70mm - 17.64mm



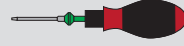

Length	Sub Series	Body				Shank				Part No
		L ₂	L ₄	L ₃	L ₁	L ₇	D ₂	Flat		
10xD	A	153.2	185.0	187.8	236.6	51.6	20	Yes	 HTA0A10-20FM	
10xD	A	153.2	185.0	187.8	236.6	51.6	20	No	 HTA0A10-20CM	
10xD	B	153.2	185.0	187.8	236.6	51.6	20	Yes	 HTA0B10-20FM	
10xD	B	153.2	185.0	187.8	236.6	51.6	20	No	 HTA0B10-20CM	
10xD	C	153.2	185.0	187.8	236.6	51.6	20	Yes	 HTA0C10-20FM	
10xD	C	153.2	185.0	187.8	236.6	51.6	20	No	 HTA0C10-20CM	
10xD	D	153.2	185.0	187.8	236.6	51.6	20	Yes	 HTA0D10-20FM	
10xD	D	153.2	185.0	187.8	236.6	51.6	20	No	 HTA0D10-20CM	
12xD	A	183.8	215.7	218.4	267.2	51.6	20	Yes	 HTA0A12-20FM	
12xD	A	183.8	215.7	218.4	267.2	51.6	20	No	 HTA0A12-20CM	
12xD	B	183.8	215.7	218.4	267.2	51.6	20	Yes	 HTA0B12-20FM	
12xD	B	183.8	215.7	218.4	267.2	51.6	20	No	 HTA0B12-20CM	
12xD	C	183.8	215.7	218.4	267.2	51.6	20	Yes	 HTA0C12-20FM	
12xD	C	183.8	215.7	218.4	267.2	51.6	20	No	 HTA0C12-20CM	
12xD	D	183.8	215.7	218.4	267.2	51.6	20	Yes	 HTA0D12-20FM	
12xD	D	183.8	215.7	218.4	267.2	51.6	20	No	 HTA0D12-20CM	
15xD	A	229.7	261.6	264.3	313.2	51.6	20	Yes	 HTA0A15-20FM	
15xD	A	229.7	261.6	264.3	313.2	51.6	20	No	 HTA0A15-20CM	
15xD	B	229.7	261.6	264.3	313.2	51.6	20	Yes	 HTA0B15-20FM	
15xD	B	229.7	261.6	264.3	313.2	51.6	20	No	 HTA0B15-20CM	
15xD	C	229.7	261.6	264.3	313.2	51.6	20	Yes	 HTA0C15-20FM	
15xD	C	229.7	261.6	264.3	313.2	51.6	20	No	 HTA0C15-20CM	
15xD	D	229.7	261.6	264.3	313.2	51.6	20	Yes	 HTA0D15-20FM	
15xD	D	229.7	261.6	264.3	313.2	51.6	20	No	 HTA0D15-20CM	

Connection Accessories

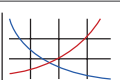

	 Insert Screws	 Nylon Locking Screws	 Insert Driver	 Preset Torque Hand Driver	 Replacement Tips	Admissible Tightening Torque*
A/B	72556-IP8-1	72556N-IP8-1	8IP-8	8IP-8TL	8IP-8B	175 N-cm (15.5 in-lbs)
C/D	72567-IP8-1	72567N-IP8-1	8IP-8	8IP-8TL	8IP-8B	175 N-cm (15.5 in-lbs)

*Tightening torques are calculated with a friction coefficient of $\mu = 0.14$ and develop 90% of ultimate yield strength

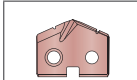
⚠ WARNING Refer to Speed and Feed charts for recommended adjustments to speeds and feeds. Refer to page A25: 68 for deep hole drilling guidelines in this section of the catalog. Visit www.alliedmachine.com/DeepHoleGuidelines for the most up-to-date information and procedures. Factory technical assistance is available for your specific applications through our Application Engineering department.
email: engineering.eu@alliedmachine.com

A25: 58 - 65  A25: 14 - 15  A25: 16 - 17 

Key on A25: 1

 = Metric (mm)
 = Imperial (in)
Screws sold in multiples of 10

A
DRILLING
B
BORING
C
REAMING
D
BURNISHING
E
THREADING
X
SPECIALS

T-A Pro Drill Holders

0 Series Imperial | Diameter Range: 0.500" - 0.694"

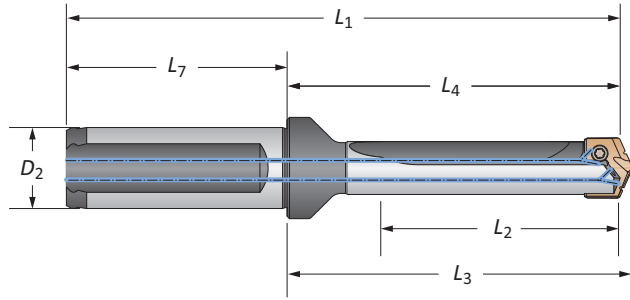

		Body				Shank				
Length	Sub Series	L ₂	L ₄	L ₃	L ₁	L ₇	D ₂	Flat	Part No	
STUB	A	0.603	1.731	1.838	3.761	2.03	3/4	Yes	HTA0A01-075F	
STUB	A	0.603	1.731	1.838	3.761	2.03	3/4	No	HTA0A01-075C	
STUB	B	0.603	1.731	1.838	3.761	2.03	3/4	Yes	HTA0B01-075F	
STUB	B	0.603	1.731	1.838	3.761	2.03	3/4	No	HTA0B01-075C	
STUB	C	0.603	1.731	1.838	3.761	2.03	3/4	Yes	HTA0C01-075F	
STUB	C	0.603	1.731	1.838	3.761	2.03	3/4	No	HTA0C01-075C	
STUB	D	0.603	1.731	1.838	3.761	2.03	3/4	Yes	HTA0D01-075F	
STUB	D	0.603	1.731	1.838	3.761	2.03	3/4	No	HTA0D01-075C	
3xD	A	1.809	3.064	3.171	5.094	2.03	3/4	Yes	HTA0A03-075F	
3xD	A	1.809	3.064	3.171	5.094	2.03	3/4	No	HTA0A03-075C	
3xD	B	1.809	3.064	3.171	5.094	2.03	3/4	Yes	HTA0B03-075F	
3xD	B	1.809	3.064	3.171	5.094	2.03	3/4	No	HTA0B03-075C	
3xD	C	1.809	3.064	3.171	5.094	2.03	3/4	Yes	HTA0C03-075F	
3xD	C	1.809	3.064	3.171	5.094	2.03	3/4	No	HTA0C03-075C	
3xD	D	1.809	3.064	3.171	5.094	2.03	3/4	Yes	HTA0D03-075F	
3xD	D	1.809	3.064	3.171	5.094	2.03	3/4	No	HTA0D03-075C	
5xD	A	3.015	4.270	4.377	6.300	2.03	3/4	Yes	HTA0A05-075F	
5xD	A	3.015	4.270	4.377	6.300	2.03	3/4	No	HTA0A05-075C	
5xD	B	3.015	4.270	4.377	6.300	2.03	3/4	Yes	HTA0B05-075F	
5xD	B	3.015	4.270	4.377	6.300	2.03	3/4	No	HTA0B05-075C	
5xD	C	3.015	4.270	4.377	6.300	2.03	3/4	Yes	HTA0C05-075F	
5xD	C	3.015	4.270	4.377	6.300	2.03	3/4	No	HTA0C05-075C	
5xD	D	3.015	4.270	4.377	6.300	2.03	3/4	Yes	HTA0D05-075F	
5xD	D	3.015	4.270	4.377	6.300	2.03	3/4	No	HTA0D05-075C	
7xD	A	4.221	5.476	5.583	7.506	2.03	3/4	Yes	HTA0A07-075F	
7xD	A	4.221	5.476	5.583	7.506	2.03	3/4	No	HTA0A07-075C	
7xD	B	4.221	5.476	5.583	7.506	2.03	3/4	Yes	HTA0B07-075F	
7xD	B	4.221	5.476	5.583	7.506	2.03	3/4	No	HTA0B07-075C	
7xD	C	4.221	5.476	5.583	7.506	2.03	3/4	Yes	HTA0C07-075F	
7xD	C	4.221	5.476	5.583	7.506	2.03	3/4	No	HTA0C07-075C	
7xD	D	4.221	5.476	5.583	7.506	2.03	3/4	Yes	HTA0D07-075F	
7xD	D	4.221	5.476	5.583	7.506	2.03	3/4	No	HTA0D07-075C	

Connection Accessories

	Insert Screws	Nylon Locking Screws	Insert Driver	Preset Torque Hand Driver	Replacement Tips	Admissible Tightening Torque*
A/B	72556-IP8-1	72556N-IP8-1	8IP-8	8IP-8TL	8IP-8B	175 N-cm (15.5 in-lbs)
C/D	72567-IP8-1	72567N-IP8-1	8IP-8	8IP-8TL	8IP-8B	175 N-cm (15.5 in-lbs)

*Tightening torques are calculated with a friction coefficient of $\mu = 0.14$ and develop 90% of ultimate yield strength

⚠ WARNING Refer to Speed and Feed charts for recommended adjustments to speeds and feeds. Refer to page A25: 68 for deep hole drilling guidelines in this section of the catalog. Visit www.alliedmachine.com/DeepHoleGuidelines for the most up-to-date information and procedures. Factory technical assistance is available for your specific applications through our Application Engineering department. email: engineering.eu@alliedmachine.com

A25: 58 - 65 A25: 14 - 15 A25: 16 - 17

Ⓜ = Metric (mm)
Ⓢ = Imperial (in)

Screws sold in multiples of 10



T-A Pro Drill Holders

0 Series Imperial | Diameter Range: 0.500" - 0.694"

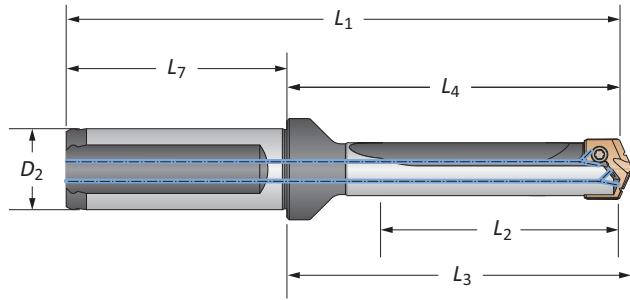

		Body				Shank				
Length	Sub Series	L ₂	L ₄	L ₃	L ₁	L ₇	D ₂	Flat	Part No	
10xD	A	6.030	7.285	7.392	9.315	2.03	3/4	Yes	⚠ HTA0A10-075F	
10xD	A	6.030	7.285	7.392	9.315	2.03	3/4	No	⚠ HTA0A10-075C	
10xD	B	6.030	7.285	7.392	9.315	2.03	3/4	Yes	⚠ HTA0B10-075F	
10xD	B	6.030	7.285	7.392	9.315	2.03	3/4	No	⚠ HTA0B10-075C	
10xD	C	6.030	7.285	7.392	9.315	2.03	3/4	Yes	⚠ HTA0C10-075F	
10xD	C	6.030	7.285	7.392	9.315	2.03	3/4	No	⚠ HTA0C10-075C	
10xD	D	6.030	7.285	7.392	9.315	2.03	3/4	Yes	⚠ HTA0D10-075F	
10xD	D	6.030	7.285	7.392	9.315	2.03	3/4	No	⚠ HTA0D10-075C	
12xD	A	7.236	8.491	8.598	10.521	2.03	3/4	Yes	⚠ HTA0A12-075F	
12xD	A	7.236	8.491	8.598	10.521	2.03	3/4	No	⚠ HTA0A12-075C	
12xD	B	7.236	8.491	8.598	10.521	2.03	3/4	Yes	⚠ HTA0B12-075F	
12xD	B	7.236	8.491	8.598	10.521	2.03	3/4	No	⚠ HTA0B12-075C	
12xD	C	7.236	8.491	8.598	10.521	2.03	3/4	Yes	⚠ HTA0C12-075F	
12xD	C	7.236	8.491	8.598	10.521	2.03	3/4	No	⚠ HTA0C12-075C	
12xD	D	7.236	8.491	8.598	10.521	2.03	3/4	Yes	⚠ HTA0D12-075F	
12xD	D	7.236	8.491	8.598	10.521	2.03	3/4	No	⚠ HTA0D12-075C	
15xD	A	9.045	10.300	10.407	12.330	2.03	3/4	Yes	⚠ HTA0A15-075F	
15xD	A	9.045	10.300	10.407	12.330	2.03	3/4	No	⚠ HTA0A15-075C	
15xD	B	9.045	10.300	10.407	12.330	2.03	3/4	Yes	⚠ HTA0B15-075F	
15xD	B	9.045	10.300	10.407	12.330	2.03	3/4	No	⚠ HTA0B15-075C	
15xD	C	9.045	10.300	10.407	12.330	2.03	3/4	Yes	⚠ HTA0C15-075F	
15xD	C	9.045	10.300	10.407	12.330	2.03	3/4	No	⚠ HTA0C15-075C	
15xD	D	9.045	10.300	10.407	12.330	2.03	3/4	Yes	⚠ HTA0D15-075F	
15xD	D	9.045	10.300	10.407	12.330	2.03	3/4	No	⚠ HTA0D15-075C	

Connection Accessories

	Insert Screws	Nylon Locking Screws	Insert Driver	Preset Torque Hand Driver	Replacement Tips	Admissible Tightening Torque*
A/B	72556-IP8-1	72556N-IP8-1	8IP-8	8IP-8TL	8IP-8B	175 N-cm (15.5 in-lbs)
C/D	72567-IP8-1	72567N-IP8-1	8IP-8	8IP-8TL	8IP-8B	175 N-cm (15.5 in-lbs)

*Tightening torques are calculated with a friction coefficient of $\mu = 0.14$ and develop 90% of ultimate yield strength

⚠ WARNING Refer to Speed and Feed charts for recommended adjustments to speeds and feeds. Refer to page A25: 68 for deep hole drilling guidelines in this section of the catalog. Visit www.alliedmachine.com/DeepHoleGuidelines for the most up-to-date information and procedures. Factory technical assistance is available for your specific applications through our Application Engineering department.
email: engineering.eu@alliedmachine.com

A25: 58 - 65 | A25: 14 - 15 | A25: 16 - 17

Ⓜ = Metric (mm)
Ⓜ = Imperial (in)





Screws sold in multiples of 10

A DRILLING
B BORING
C REAMING
D BURNISHING
E THREADING
X SPECIALS

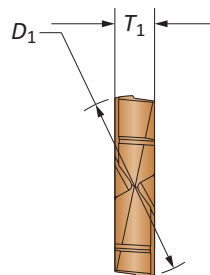
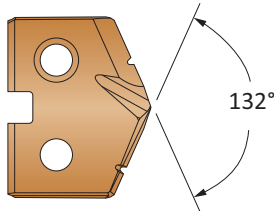
T-A Pro Carbide Drill Inserts

1 Series | Diameter Range: 17.65mm - 24.37mm (0.695" - 0.959")



Series	Insert		Fractional Equivalent	T ₁				
	D ₁ mm	D ₁ inch			Part No.	Part No.	Part No.	Part No.
1-A	17.70	0.6969		5/32	TAP1-17.70	TAK1-17.70	TAN1-17.70	TAM1-17.70
1-A	17.80	0.7008		5/32	TAP1-17.80	TAK1-17.80	TAN1-17.80	TAM1-17.80
1-A	17.86	0.7031	45/64	5/32	TAP1-17.86	TAK1-17.86	TAN1-17.86	TAM1-17.86
1-A	17.90	0.7047		5/32	TAP1-17.90	TAK1-17.90	TAN1-17.90	TAM1-17.90
1-A	18.00	0.7087		5/32	TAP1-18.00	TAK1-18.00	TAN1-18.00	TAM1-18.00
1-A	18.10	0.7126		5/32	TAP1-18.10	TAK1-18.10	TAN1-18.10	TAM1-18.10
1-A	18.20	0.7165		5/32	TAP1-18.20	TAK1-18.20	TAN1-18.20	TAM1-18.20
1-A	18.26	0.7189	23/32	5/32	TAP1-18.26	TAK1-18.26	TAN1-18.26	TAM1-18.26
1-A	18.30	0.7205		5/32	TAP1-18.30	TAK1-18.30	TAN1-18.30	TAM1-18.30
1-A	18.40	0.7244		5/32	TAP1-18.40	TAK1-18.40	TAN1-18.40	TAM1-18.40
1-A	18.50	0.7283		5/32	TAP1-18.50	TAK1-18.50	TAN1-18.50	TAM1-18.50
1-A	18.60	0.7323		5/32	TAP1-18.60	TAK1-18.60	TAN1-18.60	TAM1-18.60
1-A	18.65	0.7343	47/64	5/32	TAP1-18.65	TAK1-18.65	TAN1-18.65	TAM1-18.65
1-A	18.70	0.7362		5/32	TAP1-18.70	TAK1-18.70	TAN1-18.70	TAM1-18.70
1-A	18.80	0.7402		5/32	TAP1-18.80	TAK1-18.80	TAN1-18.80	TAM1-18.80
1-A	18.90	0.7441		5/32	TAP1-18.90	TAK1-18.90	TAN1-18.90	TAM1-18.90
1-A	19.00	0.7480		5/32	TAP1-19.00	TAK1-19.00	TAN1-19.00	TAM1-19.00

Inserts sold in multiples of 2

Sub Series Holders (A, B, C, D)

Sub series holders are recommended when running carbide inserts toward the upper end of the series drill range, as well as in tougher applications requiring more insert support and holder strength. **NOTE:** Only specified sub series inserts should be used with equivalent or smaller sub series holders.



A Series Insert + A Series Holder



C Series Insert + A Series Holder



C Series Insert + C Series Holder



A Series Insert + C Series Holder

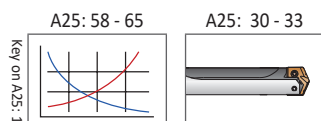



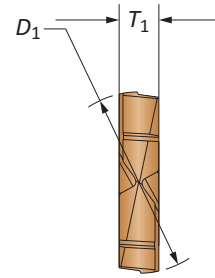
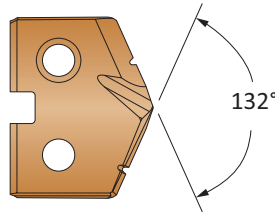

Sizes not shown are available upon request.	
When ordering, please follow the example below:	
Metric:	13.16mm, Steel, 0 series = use Part No. TAP0-13.16
Imperial:	0.5180", Steel, 0 series = use Part No. TAP0-13.16

T-A Pro Carbide Drill Inserts

1 Series | Diameter Range: 17.65mm - 24.37mm (0.695" - 0.959")



Series	Insert							
	D_1 mm	D_1 inch	Fractional Equivalent	T_1	Part No. P	Part No. K	Part No. N	Part No. M
1-B	19.05	0.7500	3/4	5/32	TAP1-19.05	TAK1-19.05	TAN1-19.05	TAM1-19.05
1-B	19.10	0.7520		5/32	TAP1-19.10	TAK1-19.10	TAN1-19.10	TAM1-19.10
1-B	19.20	0.7559		5/32	TAP1-19.20	TAK1-19.20	TAN1-19.20	TAM1-19.20
1-B	19.25	0.7579		5/32	TAP1-19.25	TAK1-19.25	TAN1-19.25	TAM1-19.25
1-B	19.30	0.7598		5/32	TAP1-19.30	TAK1-19.30	TAN1-19.30	TAM1-19.30
1-B	19.40	0.7638		5/32	TAP1-19.40	TAK1-19.40	TAN1-19.40	TAM1-19.40
1-B	19.45	0.7657	49/64	5/32	TAP1-19.45	TAK1-19.45	TAN1-19.45	TAM1-19.45
1-B	19.50	0.7677		5/32	TAP1-19.50	TAK1-19.50	TAN1-19.50	TAM1-19.50
1-B	19.60	0.7717		5/32	TAP1-19.60	TAK1-19.60	TAN1-19.60	TAM1-19.60
1-B	19.70	0.7756		5/32	TAP1-19.70	TAK1-19.70	TAN1-19.70	TAM1-19.70
1-B	19.80	0.7795		5/32	TAP1-19.80	TAK1-19.80	TAN1-19.80	TAM1-19.80
1-B	19.84	0.7811	25/32	5/32	TAP1-19.84	TAK1-19.84	TAN1-19.84	TAM1-19.84
1-B	19.90	0.7835		5/32	TAP1-19.90	TAK1-19.90	TAN1-19.90	TAM1-19.90
1-B	20.00	0.7874		5/32	TAP1-20.00	TAK1-20.00	TAN1-20.00	TAM1-20.00
1-B	20.10	0.7913		5/32	TAP1-20.10	TAK1-20.10	TAN1-20.10	TAM1-20.10
1-B	20.20	0.7953		5/32	TAP1-20.20	TAK1-20.20	TAN1-20.20	TAM1-20.20
1-B	20.24	0.7969	51/64	5/32	TAP1-20.24	TAK1-20.24	TAN1-20.24	TAM1-20.24
1-B	20.30	0.7992		5/32	TAP1-20.30	TAK1-20.30	TAN1-20.30	TAM1-20.30
1-B	20.40	0.8031		5/32	TAP1-20.40	TAK1-20.40	TAN1-20.40	TAM1-20.40
1-B	20.50	0.8071		5/32	TAP1-20.50	TAK1-20.50	TAN1-20.50	TAM1-20.50

Inserts sold in multiples of 2

Sub Series Holders (A, B, C, D)

Sub series holders are recommended when running carbide inserts toward the upper end of the series drill range, as well as in tougher applications requiring more insert support and holder strength. **NOTE:** Only specified sub series inserts should be used with equivalent or smaller sub series holders.



A Series Insert +
A Series Holder



C Series Insert +
A Series Holder



C Series Insert +
C Series Holder



A Series Insert +
C Series Holder

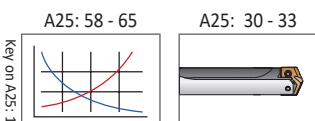



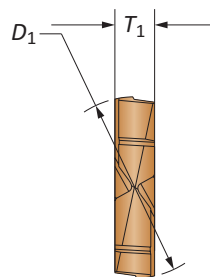
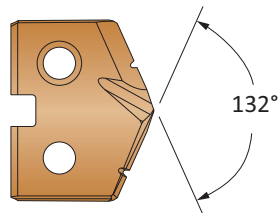

Sizes not shown are available upon request.	
When ordering, please follow the example below:	
Metric:	13.16mm, Steel, 0 series = use Part No. TAP0-13.16
Imperial:	0.5180", Steel, 0 series = use Part No. TAP0-13.16

T-A Pro Carbide Drill Inserts

1 Series | Diameter Range: 17.65mm - 24.37mm (0.695" - 0.959")



Series	Insert				 Part No.	 Part No.	 Part No.	 Part No.
	D_1 mm	D_1 inch	Fractional Equivalent	T_1	P	K	N	M
1-C	20.60	0.8110		5/32	TAP1-20.60	TAK1-20.60	TAN1-20.60	TAM1-20.60
1-C	20.64	0.8126	13/16	5/32	TAP1-20.64	TAK1-20.64	TAN1-20.64	TAM1-20.64
1-C	20.70	0.8150		5/32	TAP1-20.70	TAK1-20.70	TAN1-20.70	TAM1-20.70
1-C	20.80	0.8189		5/32	TAP1-20.80	TAK1-20.80	TAN1-20.80	TAM1-20.80
1-C	20.90	0.8228		5/32	TAP1-20.90	TAK1-20.90	TAN1-20.90	TAM1-20.90
1-C	21.00	0.8268		5/32	TAP1-21.00	TAK1-21.00	TAN1-21.00	TAM1-21.00
1-C	21.10	0.8307		5/32	TAP1-21.10	TAK1-21.10	TAN1-21.10	TAM1-21.10
1-C	21.20	0.8346		5/32	TAP1-21.20	TAK1-21.20	TAN1-21.20	TAM1-21.20
1-C	21.30	0.8386		5/32	TAP1-21.30	TAK1-21.30	TAN1-21.30	TAM1-21.30
1-C	21.40	0.8425		5/32	TAP1-21.40	TAK1-21.40	TAN1-21.40	TAM1-21.40
1-C	21.43	0.8437	27/32	5/32	TAP1-21.43	TAK1-21.43	TAN1-21.43	TAM1-21.43
1-C	21.50	0.8465		5/32	TAP1-21.50	TAK1-21.50	TAN1-21.50	TAM1-21.50
1-C	21.60	0.8504		5/32	TAP1-21.60	TAK1-21.60	TAN1-21.60	TAM1-21.60
1-C	21.70	0.8543		5/32	TAP1-21.70	TAK1-21.70	TAN1-21.70	TAM1-21.70
1-C	21.80	0.8583		5/32	TAP1-21.80	TAK1-21.80	TAN1-21.80	TAM1-21.80
1-C	21.83	0.8594	55/64	5/32	TAP1-21.83	TAK1-21.83	TAN1-21.83	TAM1-21.83
1-C	21.90	0.8622		5/32	TAP1-21.90	TAK1-21.90	TAN1-21.90	TAM1-21.90
1-C	22.00	0.8661		5/32	TAP1-22.00	TAK1-22.00	TAN1-22.00	TAM1-22.00
1-C	22.10	0.8701		5/32	TAP1-22.10	TAK1-22.10	TAN1-22.10	TAM1-22.10
1-C	22.20	0.8740		5/32	TAP1-22.20	TAK1-22.20	TAN1-22.20	TAM1-22.20
1-C	22.23	0.8752	7/8	5/32	TAP1-22.23	TAK1-22.23	TAN1-22.23	TAM1-22.23
1-C	22.30	0.8780		5/32	TAP1-22.30	TAK1-22.30	TAN1-22.30	TAM1-22.30
1-C	22.40	0.8819		5/32	TAP1-22.40	TAK1-22.40	TAN1-22.40	TAM1-22.40
1-C	22.50	0.8858		5/32	TAP1-22.50	TAK1-22.50	TAN1-22.50	TAM1-22.50
1-C	22.62	0.8906	57/64	5/32	TAP1-22.62	TAK1-22.62	TAN1-22.62	TAM1-22.62
1-C	22.70	0.8937		5/32	TAP1-22.70	TAK1-22.70	TAN1-22.70	TAM1-22.70
1-C	22.80	0.8976		5/32	TAP1-22.80	TAK1-22.80	TAN1-22.80	TAM1-22.80

Inserts sold in multiples of 2

Sub Series Holders (A, B, C, D)

Sub series holders are recommended when running carbide inserts toward the upper end of the series drill range, as well as in tougher applications requiring more insert support and holder strength. **NOTE:** Only specified sub series inserts should be used with equivalent or smaller sub series holders.



A Series Insert +
A Series Holder



C Series Insert +
A Series Holder



C Series Insert +
C Series Holder



A Series Insert +
C Series Holder

A25: 58 - 65

A25: 30 - 33

Key on A25: 1

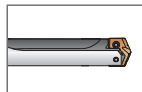
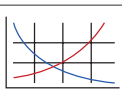

Sizes not shown are available upon request.





When ordering, please follow the example below:

Metric:	13.16mm, Steel, 0 series = use Part No. TAP0-13.16
Imperial:	0.5180", Steel, 0 series = use Part No. TAP0-13.16

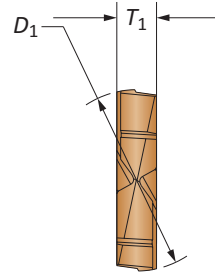
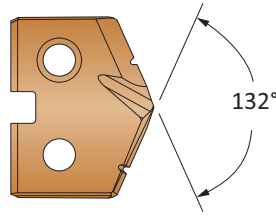
T-A Pro Carbide Drill Inserts

1 Series | Diameter Range: 17.65mm - 24.37mm (0.695" - 0.959")



Series	Insert							
	D_1 mm	D_1 inch	Fractional Equivalent	T_1	Part No.	Part No.	Part No.	Part No.
					P	K	N	M
1-D	22.90	0.9016		5/32	TAP1-22.90	TAK1-22.90	TAN1-22.90	TAM1-22.90
1-D	23.00	0.9055		5/32	TAP1-23.00	TAK1-23.00	TAN1-23.00	TAM1-23.00
1-D	23.02	0.9063	29/32	5/32	TAP1-23.02	TAK1-23.02	TAN1-23.02	TAM1-23.02
1-D	23.10	0.9094		5/32	TAP1-23.10	TAK1-23.10	TAN1-23.10	TAM1-23.10
1-D	23.20	0.9134		5/32	TAP1-23.20	TAK1-23.20	TAN1-23.20	TAM1-23.20
1-D	23.30	0.9173		5/32	TAP1-23.30	TAK1-23.30	TAN1-23.30	TAM1-23.30
1-D	23.42	0.9220	59/64	5/32	TAP1-23.42	TAK1-23.42	TAN1-23.42	TAM1-23.42
1-D	23.50	0.9252		5/32	TAP1-23.50	TAK1-23.50	TAN1-23.50	TAM1-23.50
1-D	23.60	0.9291		5/32	TAP1-23.60	TAK1-23.60	TAN1-23.60	TAM1-23.60
1-D	23.70	0.9331		5/32	TAP1-23.70	TAK1-23.70	TAN1-23.70	TAM1-23.70
1-D	23.81	0.9374	15/16	5/32	TAP1-23.81	TAK1-23.81	TAN1-23.81	TAM1-23.81
1-D	23.90	0.9409		5/32	TAP1-23.90	TAK1-23.90	TAN1-23.90	TAM1-23.90
1-D	24.00	0.9449		5/32	TAP1-24.00	TAK1-24.00	TAN1-24.00	TAM1-24.00
1-D	24.10	0.9488		5/32	TAP1-24.10	TAK1-24.10	TAN1-24.10	TAM1-24.10
1-D	24.20	0.9528		5/32	TAP1-24.20	TAK1-24.20	TAN1-24.20	TAM1-24.20
1-D	24.30	0.9567		5/32	TAP1-24.30	TAK1-24.30	TAN1-24.30	TAM1-24.30

Inserts sold in multiples of 2

A DRILLING
B BORING
C REAMING
D BURNISHING
E THREADING
X SPECIALS

Sub Series Holders (A, B, C, D)

Sub series holders are recommended when running carbide inserts toward the upper end of the series drill range, as well as in tougher applications requiring more insert support and holder strength. **NOTE:** Only specified sub series inserts should be used with equivalent or smaller sub series holders.



A Series Insert +
A Series Holder



C Series Insert +
A Series Holder



C Series Insert +
C Series Holder



A Series Insert +
C Series Holder

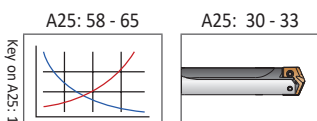

Sizes not shown are available upon request.	
When ordering, please follow the example below:	
Metric:	13.16mm, Steel, 0 series = use Part No. TAP0-13.16
Imperial:	0.5180", Steel, 0 series = use Part No. TAP0-13.16

T-A Pro HSS Drill Inserts

1 Series | Diameter Range: 17.65mm - 24.37mm (0.695" - 0.959")

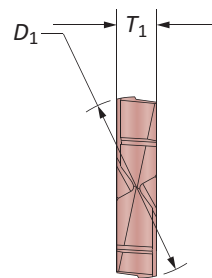
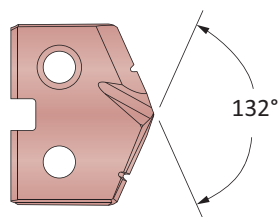
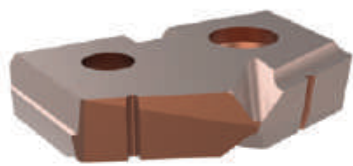

Series	D ₁ mm	D ₁ inch	Fractional Equivalent	T ₁	Insert
					Part No.
1-A	17.70	0.6969		5/32	TAX1-17.70
1-A	17.80	0.7008		5/32	TAX1-17.80
1-A	17.86	0.7031	45/64	5/32	TAX1-17.86
1-A	17.90	0.7047		5/32	TAX1-17.90
1-A	18.00	0.7087		5/32	TAX1-18.00
1-A	18.10	0.7126		5/32	TAX1-18.10
1-A	18.20	0.7165		5/32	TAX1-18.20
1-A	18.26	0.7189	23/32	5/32	TAX1-18.26
1-A	18.30	0.7205		5/32	TAX1-18.30
1-A	18.40	0.7244		5/32	TAX1-18.40
1-A	18.50	0.7283		5/32	TAX1-18.50
1-A	18.60	0.7323		5/32	TAX1-18.60
1-A	18.65	0.7343	47/64	5/32	TAX1-18.65
1-A	18.70	0.7362		5/32	TAX1-18.70
1-A	18.80	0.7402		5/32	TAX1-18.80
1-A	18.90	0.7441		5/32	TAX1-18.90
1-A	19.00	0.7480		5/32	TAX1-19.00

Inserts sold in multiples of 2

Sub Series Holders (A, B, C, D)

Sub series holders are recommended when running carbide inserts toward the upper end of the series drill range, as well as in tougher applications requiring more insert support and holder strength. **NOTE:** Only specified sub series inserts should be used with equivalent or smaller sub series holders.



A Series Insert +
A Series Holder



C Series Insert +
A Series Holder



C Series Insert +
C Series Holder



A Series Insert +
C Series Holder

A25: 58 - 65

A25: 30 - 33

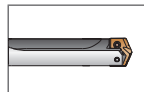
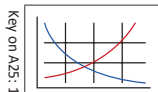

Sizes not shown are available upon request.

When ordering, please follow the example below:

Metric:	13.16mm, Steel, 0 series = use Part No. TAP0-13.16
Imperial:	0.5180", Steel, 0 series = use Part No. TAP0-13.16

T-A Pro HSS Drill Inserts

1 Series | Diameter Range: 17.65mm - 24.37mm (0.695" - 0.959")

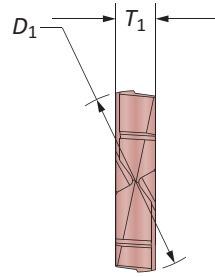
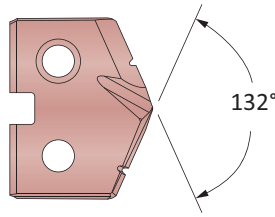

Series	D ₁ mm	D ₁ inch	Fractional Equivalent	T ₁	
					Part No.
1-B	19.05	0.7500	3/4	5/32	TAX1-19.05
1-B	19.10	0.7520		5/32	TAX1-19.10
1-B	19.20	0.7559		5/32	TAX1-19.20
1-B	19.25	0.7579		5/32	TAX1-19.25
1-B	19.30	0.7598		5/32	TAX1-19.30
1-B	19.40	0.7638		5/32	TAX1-19.40
1-B	19.45	0.7657	49/64	5/32	TAX1-19.45
1-B	19.50	0.7677		5/32	TAX1-19.50
1-B	19.60	0.7717		5/32	TAX1-19.60
1-B	19.70	0.7756		5/32	TAX1-19.70
1-B	19.80	0.7795		5/32	TAX1-19.80
1-B	19.84	0.7811	25/32	5/32	TAX1-19.84
1-B	19.90	0.7835		5/32	TAX1-19.90
1-B	20.00	0.7874		5/32	TAX1-20.00
1-B	20.10	0.7913		5/32	TAX1-20.10
1-B	20.20	0.7953		5/32	TAX1-20.20
1-B	20.24	0.7969	51/64	5/32	TAX1-20.24
1-B	20.30	0.7992		5/32	TAX1-20.30
1-B	20.40	0.8031		5/32	TAX1-20.40
1-B	20.50	0.8071		5/32	TAX1-20.50

Inserts sold in multiples of 2

A
DRILLING
B
BORING
C
REAMING
D
BURNISHING
E
THREADING
X
SPECIALS

Sub Series Holders (A, B, C, D)

Sub series holders are recommended when running carbide inserts toward the upper end of the series drill range, as well as in tougher applications requiring more insert support and holder strength. **NOTE:** Only specified sub series inserts should be used with equivalent or smaller sub series holders.



A Series Insert +
A Series Holder



C Series Insert +
A Series Holder



C Series Insert +
C Series Holder



A Series Insert +
C Series Holder

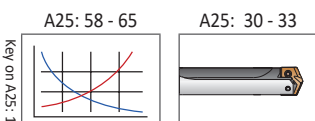

Sizes not shown are available upon request.	
When ordering, please follow the example below:	
Metric:	13.16mm, Steel, 0 series = use Part No. TAP0-13.16
Imperial:	0.5180", Steel, 0 series = use Part No. TAP0-13.16

T-A Pro HSS Drill Inserts

1 Series | Diameter Range: 17.65mm - 24.37mm (0.695" - 0.959")

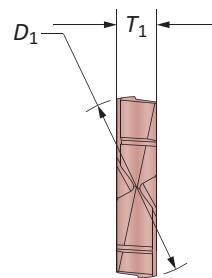
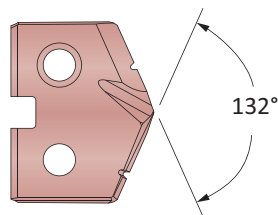

Series	D ₁ mm	D ₁ inch	Fractional Equivalent	T ₁	 Part No.
					X
1-C	20.60	0.8110		5/32	TAX1-20.60
1-C	20.64	0.8126	13/16	5/32	TAX1-20.64
1-C	20.70	0.8150		5/32	TAX1-20.70
1-C	20.80	0.8189		5/32	TAX1-20.80
1-C	20.90	0.8228		5/32	TAX1-20.90
1-C	21.00	0.8268		5/32	TAX1-21.00
1-C	21.10	0.8307		5/32	TAX1-21.10
1-C	21.20	0.8346		5/32	TAX1-21.20
1-C	21.30	0.8386		5/32	TAX1-21.30
1-C	21.40	0.8425		5/32	TAX1-21.40
1-C	21.43	0.8437	27/32	5/32	TAX1-21.43
1-C	21.50	0.8465		5/32	TAX1-21.50
1-C	21.60	0.8504		5/32	TAX1-21.60
1-C	21.70	0.8543		5/32	TAX1-21.70
1-C	21.80	0.8583		5/32	TAX1-21.80
1-C	21.83	0.8594	55/64	5/32	TAX1-21.83
1-C	21.90	0.8622		5/32	TAX1-21.90
1-C	22.00	0.8661		5/32	TAX1-22.00
1-C	22.10	0.8701		5/32	TAX1-22.10
1-C	22.20	0.8740		5/32	TAX1-22.20
1-C	22.23	0.8752	7/8	5/32	TAX1-22.23
1-C	22.30	0.8780		5/32	TAX1-22.30
1-C	22.40	0.8819		5/32	TAX1-22.40
1-C	22.50	0.8858		5/32	TAX1-22.50
1-C	22.62	0.8906	57/34	5/32	TAX1-22.62
1-C	22.70	0.8937		5/32	TAX1-22.70
1-C	22.80	0.8976		5/32	TAX1-22.80

Inserts sold in multiples of 2

Sub Series Holders (A, B, C, D)

Sub series holders are recommended when running carbide inserts toward the upper end of the series drill range, as well as in tougher applications requiring more insert support and holder strength. **NOTE:** Only specified sub series inserts should be used with equivalent or smaller sub series holders.



A Series Insert +
A Series Holder



C Series Insert +
A Series Holder



C Series Insert +
C Series Holder



A Series Insert +
C Series Holder

A25: 58 - 65

A25: 30 - 33

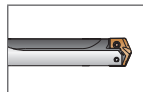
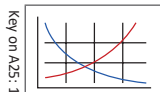



Sizes not shown are available upon request.
When ordering, please follow the example below:

Metric:	13.16mm, Steel, 0 series = use Part No. TAP0-13.16
Imperial:	0.5180", Steel, 0 series = use Part No. TAP0-13.16

T-A Pro HSS Drill Inserts

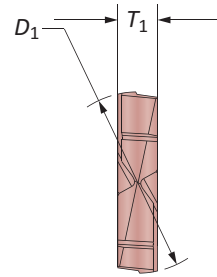
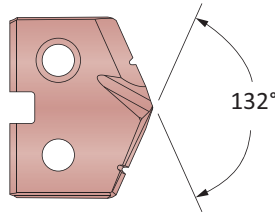
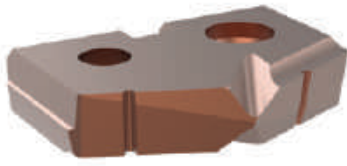
1 Series | Diameter Range: 17.65mm - 24.37mm (0.695" - 0.959")



Series	D ₁ mm	D ₁ inch	Fractional Equivalent	T ₁	
					Part No.
1-D	22.90	0.9016		5/32	TAX1-22.90
1-D	23.00	0.9055		5/32	TAX1-23.00
1-D	23.02	0.9063	29/32	5/32	TAX1-23.02
1-D	23.10	0.9094		5/32	TAX1-23.10
1-D	23.20	0.9134		5/32	TAX1-23.20
1-D	23.30	0.9173		5/32	TAX1-23.30
1-D	23.42	0.9220	59/64	5/32	TAX1-23.42
1-D	23.50	0.9252		5/32	TAX1-23.50
1-D	23.60	0.9291		5/32	TAX1-23.60
1-D	23.70	0.9331		5/32	TAX1-23.70
1-D	23.81	0.9374	15/16	5/32	TAX1-23.81
1-D	23.90	0.9409		5/32	TAX1-23.90
1-D	24.00	0.9449		5/32	TAX1-24.00
1-D	24.10	0.9488		5/32	TAX1-24.10
1-D	24.20	0.9528		5/32	TAX1-24.20
1-D	24.30	0.9567		5/32	TAX1-24.30

Inserts sold in multiples of 2

A

DRILLING

B

BORING

C

REAMING

D

BURNISHING

F

THREADING

X

SPECIALS

Sub Series Holders (A, B, C, D)

Sub series holders are recommended when running carbide inserts toward the upper end of the series drill range, as well as in tougher applications requiring more insert support and holder strength. **NOTE:** Only specified sub series inserts should be used with equivalent or smaller sub series holders.



A Series Insert +
A Series Holder



C Series Insert +
A Series Holder



C Series Insert +
C Series Holder



A Series Insert +
C Series Holder

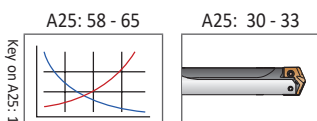

Sizes not shown are available upon request.	
When ordering, please follow the example below:	
Metric:	13.16mm, Steel, 0 series = use Part No. TAP0-13.16
Imperial:	0.5180", Steel, 0 series = use Part No. TAP0-13.16

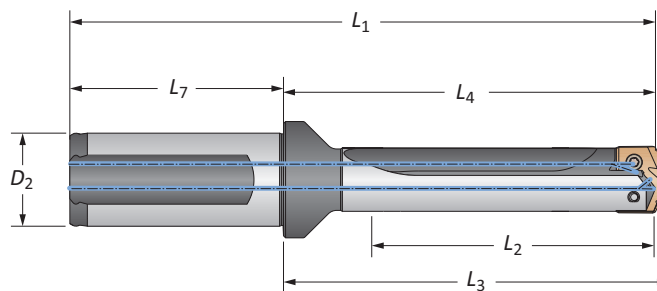

T-A Pro Drill Holders

1 Series Metric | Diameter Range: 17.65mm - 24.37mm



		Body				Shank				
Length	Sub Series	L ₂	L ₄	L ₃	L ₁	L ₇	D ₂	Flat	Part No	
STUB	A	21.0	56.5	60.0	114.4	57.9	25	Yes	HTA1A01-25FM	
STUB	A	21.0	56.5	60.0	114.4	57.9	25	No	HTA1A01-25CM	
STUB	B	21.0	56.5	60.0	114.4	57.9	25	Yes	HTA1B01-25FM	
STUB	B	21.0	56.5	60.0	114.4	57.9	25	No	HTA1B01-25CM	
STUB	C	21.0	56.5	60.0	114.4	57.9	25	Yes	HTA1C01-25FM	
STUB	C	21.0	56.5	60.0	114.4	57.9	25	No	HTA1C01-25CM	
STUB	D	21.0	56.5	60.0	114.4	57.9	25	Yes	HTA1D01-25FM	
STUB	D	21.0	56.5	60.0	114.4	57.9	25	No	HTA1D01-25CM	
3xD	A	62.9	100.9	104.5	158.8	57.9	25	Yes	HTA1A03-25FM	
3xD	A	62.9	100.9	104.5	158.8	57.9	25	No	HTA1A03-25CM	
3xD	B	62.9	100.9	104.5	158.8	57.9	25	Yes	HTA1B03-25FM	
3xD	B	62.9	100.9	104.5	158.8	57.9	25	No	HTA1B03-25CM	
3xD	C	62.9	100.9	104.5	158.8	57.9	25	Yes	HTA1C03-25FM	
3xD	C	62.9	100.9	104.5	158.8	57.9	25	No	HTA1C03-25CM	
3xD	D	62.9	100.9	104.5	158.8	57.9	25	Yes	HTA1D03-25FM	
3xD	D	62.9	100.9	104.5	158.8	57.9	25	No	HTA1D03-25CM	
5xD	A	104.8	142.8	146.4	200.7	57.9	25	Yes	HTA1A05-25FM	
5xD	A	104.8	142.8	146.4	200.7	57.9	25	No	HTA1A05-25CM	
5xD	B	104.8	142.8	146.4	200.7	57.9	25	Yes	HTA1B05-25FM	
5xD	B	104.8	142.8	146.4	200.7	57.9	25	No	HTA1B05-25CM	
5xD	C	104.8	142.8	146.4	200.7	57.9	25	Yes	HTA1C05-25FM	
5xD	C	104.8	142.8	146.4	200.7	57.9	25	No	HTA1C05-25CM	
5xD	D	104.8	142.8	146.4	200.7	57.9	25	Yes	HTA1D05-25FM	
5xD	D	104.8	142.8	146.4	200.7	57.9	25	No	HTA1D05-25CM	
7xD	A	146.7	184.7	188.3	242.7	57.9	25	Yes	HTA1A07-25FM	
7xD	A	146.7	184.7	188.3	242.7	57.9	25	No	HTA1A07-25CM	
7xD	B	146.7	184.7	188.3	242.7	57.9	25	Yes	HTA1B07-25FM	
7xD	B	146.7	184.7	188.3	242.7	57.9	25	No	HTA1B07-25CM	
7xD	C	146.7	184.7	188.3	242.7	57.9	25	Yes	HTA1C07-25FM	
7xD	C	146.7	184.7	188.3	242.7	57.9	25	No	HTA1C07-25CM	
7xD	D	146.7	184.7	188.3	242.7	57.9	25	Yes	HTA1D07-25FM	
7xD	D	146.7	184.7	188.3	242.7	57.9	25	No	HTA1D07-25CM	

Connection Accessories

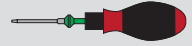
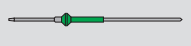
	 Insert Screws	 Nylon Locking Screws	 Insert Driver	 Preset Torque Hand Driver	 Replacement Tips	Admissible Tightening Torque*
A/B	7375-IP9-1	7375N-IP9-1	8IP-9	8IP-9TL	8IP-9B	305 N-cm (27.0 in-lbs)
C/D	739-IP9-1	739N-IP9-1	8IP-9	8IP-9TL	8IP-9B	305 N-cm (27.0 in-lbs)

*Tightening torques are calculated with a friction coefficient of $\mu = 0.14$ and develop 90% of ultimate yield strength

1. WARNING Refer to Speed and Feed charts for recommended adjustments to speeds and feeds. Refer to page A25: 68 for deep hole drilling guidelines in this section of the catalog. Visit www.alliedmachine.com/DeepHoleGuidelines for the most up-to-date information and procedures. Factory technical assistance is available for your specific applications through our Application Engineering department.
email: engineering.eu@alliedmachine.com

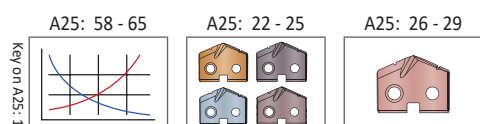

 = Metric (mm)
 = Imperial (in)

Screws sold in multiples of 10



T-A Pro Drill Holders

1 Series Metric | Diameter Range: 17.65mm - 24.37mm

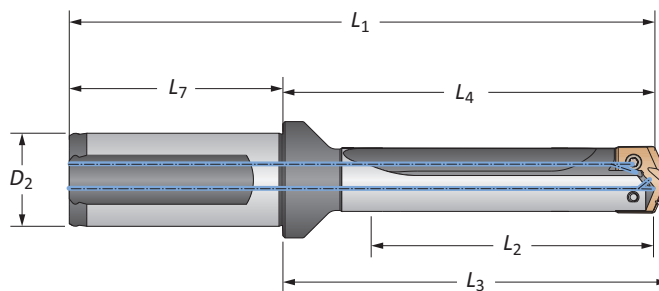

Length	Sub Series	Body				Shank				Part No
		L ₂	L ₄	L ₃	L ₁	L ₇	D ₂	Flat		
10xD	A	209.6	247.6	251.2	305.5	57.9	25	Yes	HTA1A10-25FM	
10xD	A	209.6	247.6	251.2	305.5	57.9	25	No	HTA1A10-25CM	
10xD	B	209.6	247.6	251.2	305.5	57.9	25	Yes	HTA1B10-25FM	
10xD	B	209.6	247.6	251.2	305.5	57.9	25	No	HTA1B10-25CM	
10xD	C	209.6	247.6	251.2	305.5	57.9	25	Yes	HTA1C10-25FM	
10xD	C	209.6	247.6	251.2	305.5	57.9	25	No	HTA1C10-25CM	
10xD	D	209.6	247.6	251.2	305.5	57.9	25	Yes	HTA1D10-25FM	
10xD	D	209.6	247.6	251.2	305.5	57.9	25	No	HTA1D10-25CM	
12xD	A	251.5	289.5	293.1	347.4	57.9	25	Yes	HTA1A12-25FM	
12xD	A	251.5	289.5	293.1	347.4	57.9	25	No	HTA1A12-25CM	
12xD	B	251.5	289.5	293.1	347.4	57.9	25	Yes	HTA1B12-25FM	
12xD	B	251.5	289.5	293.1	347.4	57.9	25	No	HTA1B12-25CM	
12xD	C	251.5	289.5	293.1	347.4	57.9	25	Yes	HTA1C12-25FM	
12xD	C	251.5	289.5	293.1	347.4	57.9	25	No	HTA1C12-25CM	
12xD	D	251.5	289.5	293.1	347.4	57.9	25	Yes	HTA1D12-25FM	
12xD	D	251.5	289.5	293.1	347.4	57.9	25	No	HTA1D12-25CM	
15xD	A	314.3	352.4	355.9	410.3	57.9	25	Yes	HTA1A15-25FM	
15xD	A	314.3	352.4	355.9	410.3	57.9	25	No	HTA1A15-25CM	
15xD	B	314.3	352.4	355.9	410.3	57.9	25	Yes	HTA1B15-25FM	
15xD	B	314.3	352.4	355.9	410.3	57.9	25	No	HTA1B15-25CM	
15xD	C	314.3	352.4	355.9	410.3	57.9	25	Yes	HTA1C15-25FM	
15xD	C	314.3	352.4	355.9	410.3	57.9	25	No	HTA1C15-25CM	
15xD	D	314.3	352.4	355.9	410.3	57.9	25	Yes	HTA1D15-25FM	
15xD	D	314.3	352.4	355.9	410.3	57.9	25	No	HTA1D15-25CM	

Connection Accessories

	Insert Screws	Nylon Locking Screws	Insert Driver	Preset Torque Hand Driver	Replacement Tips	Admissible Tightening Torque*
A/B	7375-IP9-1	7375N-IP9-1	8IP-9	8IP-9TL	8IP-9B	305 N-cm (27.0 in-lbs)
C/D	739-IP9-1	739N-IP9-1	8IP-9	8IP-9TL	8IP-9B	305 N-cm (27.0 in-lbs)

*Tightening torques are calculated with a friction coefficient of $\mu = 0.14$ and develop 90% of ultimate yield strength

WARNING Refer to Speed and Feed charts for recommended adjustments to speeds and feeds. Refer to page A25: 68 for deep hole drilling guidelines in this section of the catalog. Visit www.alliedmachine.com/DeepHoleGuidelines for the most up-to-date information and procedures. Factory technical assistance is available for your specific applications through our Application Engineering department. email: engineering.eu@alliedmachine.com

A25: 58 - 65 A25: 22 - 25 A25: 26 - 29

Ⓜ = Metric (mm)
Ⓢ = Imperial (in)

Screws sold in multiples of 10

A DRILLING
B BORING
C REAMING
D BURNISHING
E THREADING
X SPECIALS



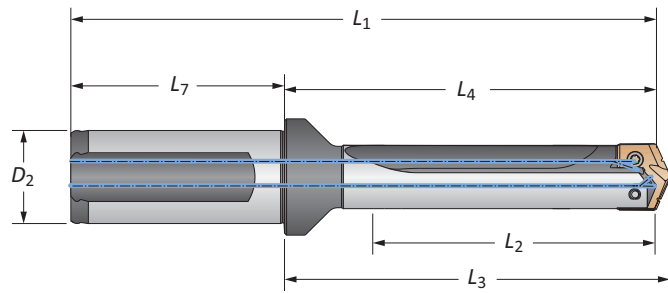

T-A Pro Drill Holders

1 Series Imperial | Diameter Range: 0.695" - 0.959"

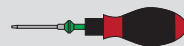

		Body				Shank				
Length	Sub Series	L ₂	L ₄	L ₃	L ₁	L ₇	D ₂	Flat	Part No	
STUB	A	0.825	2.224	2.364	4.504	2.280	1.00	Yes	HTA1A01-100F	
STUB	A	0.825	2.224	2.364	4.504	2.280	1.00	No	HTA1A01-100C	
STUB	B	0.825	2.224	2.364	4.504	2.280	1.00	Yes	HTA1B01-100F	
STUB	B	0.825	2.224	2.364	4.504	2.280	1.00	No	HTA1B01-100C	
STUB	C	0.825	2.224	2.364	4.504	2.280	1.00	Yes	HTA1C01-100F	
STUB	C	0.825	2.224	2.364	4.504	2.280	1.00	No	HTA1C01-100C	
STUB	D	0.825	2.224	2.364	4.504	2.280	1.00	Yes	HTA1D01-100F	
STUB	D	0.825	2.224	2.364	4.504	2.280	1.00	No	HTA1D01-100C	
3xD	A	2.475	3.973	4.113	6.253	2.280	1.00	Yes	HTA1A03-100F	
3xD	A	2.475	3.973	4.113	6.253	2.280	1.00	No	HTA1A03-100C	
3xD	B	2.475	3.973	4.113	6.253	2.280	1.00	Yes	HTA1B03-100F	
3xD	B	2.475	3.973	4.113	6.253	2.280	1.00	No	HTA1B03-100C	
3xD	C	2.475	3.973	4.113	6.253	2.280	1.00	Yes	HTA1C03-100F	
3xD	C	2.475	3.973	4.113	6.253	2.280	1.00	No	HTA1C03-100C	
3xD	D	2.475	3.973	4.113	6.253	2.280	1.00	Yes	HTA1D03-100F	
3xD	D	2.475	3.973	4.113	6.253	2.280	1.00	No	HTA1D03-100C	
5xD	A	4.125	5.623	5.763	7.903	2.280	1.00	Yes	HTA1A05-100F	
5xD	A	4.125	5.623	5.763	7.903	2.280	1.00	No	HTA1A05-100C	
5xD	B	4.125	5.623	5.763	7.903	2.280	1.00	Yes	HTA1B05-100F	
5xD	B	4.125	5.623	5.763	7.903	2.280	1.00	No	HTA1B05-100C	
5xD	C	4.125	5.623	5.763	7.903	2.280	1.00	Yes	HTA1C05-100F	
5xD	C	4.125	5.623	5.763	7.903	2.280	1.00	No	HTA1C05-100C	
5xD	D	4.125	5.623	5.763	7.903	2.280	1.00	Yes	HTA1D05-100F	
5xD	D	4.125	5.623	5.763	7.903	2.280	1.00	No	HTA1D05-100C	
7xD	A	5.775	7.273	7.413	9.553	2.280	1.00	Yes	HTA1A07-100F	
7xD	A	5.775	7.273	7.413	9.553	2.280	1.00	No	HTA1A07-100C	
7xD	B	5.775	7.273	7.413	9.553	2.280	1.00	Yes	HTA1B07-100F	
7xD	B	5.775	7.273	7.413	9.553	2.280	1.00	No	HTA1B07-100C	
7xD	C	5.775	7.273	7.413	9.553	2.280	1.00	Yes	HTA1C07-100F	
7xD	C	5.775	7.273	7.413	9.553	2.280	1.00	No	HTA1C07-100C	
7xD	D	5.775	7.273	7.413	9.553	2.280	1.00	Yes	HTA1D07-100F	
7xD	D	5.775	7.273	7.413	9.553	2.280	1.00	No	HTA1D07-100C	

Connection Accessories

	 Insert Screws	 Nylon Locking Screws	 Insert Driver	 Preset Torque Hand Driver	 Replacement Tips	Admissible Tightening Torque*
A/B	7375-IP9-1	7375N-IP9-1	8IP-9	8IP-9TL	8IP-9B	305 N-cm (27.0 in-lbs)
C/D	739-IP9-1	739N-IP9-1	8IP-9	8IP-9TL	8IP-9B	305 N-cm (27.0 in-lbs)

*Tightening torques are calculated with a friction coefficient of $\mu = 0.14$ and develop 90% of ultimate yield strength

1. WARNING Refer to Speed and Feed charts for recommended adjustments to speeds and feeds. Refer to page A25: 68 for deep hole drilling guidelines in this section of the catalog. Visit www.alliedmachine.com/DeepHoleGuidelines for the most up-to-date information and procedures. Factory technical assistance is available for your specific applications through our Application Engineering department.
email: engineering.eu@alliedmachine.com

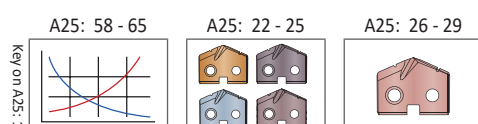

 = Metric (mm)
 = Imperial (in)

Screws sold in multiples of 10

T-A Pro Drill Holders

1 Series Imperial | Diameter Range: 0.695" - 0.959"

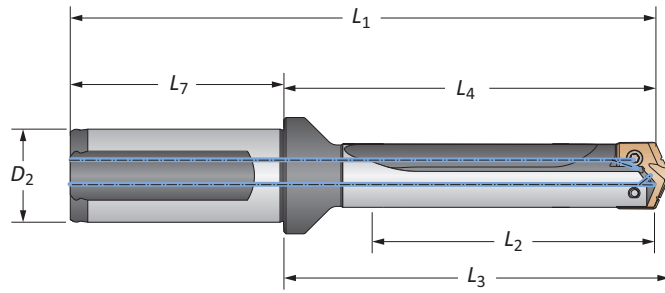

		Body				Shank				
Length	Sub Series	L ₂	L ₄	L ₃	L ₁	L ₇	D ₂	Flat	Part No	
10xD	A	8.250	9.748	9.888	12.028	2.280	1.00	Yes	HTA1A10-100F	
10xD	A	8.250	9.748	9.888	12.028	2.280	1.00	No	HTA1A10-100C	
10xD	B	8.250	9.748	9.888	12.028	2.280	1.00	Yes	HTA1B10-100F	
10xD	B	8.250	9.748	9.888	12.028	2.280	1.00	No	HTA1B10-100C	
10xD	C	8.250	9.748	9.888	12.028	2.280	1.00	Yes	HTA1C10-100F	
10xD	C	8.250	9.748	9.888	12.028	2.280	1.00	No	HTA1C10-100C	
10xD	D	8.250	9.748	9.888	12.028	2.280	1.00	Yes	HTA1D10-100F	
10xD	D	8.250	9.748	9.888	12.028	2.280	1.00	No	HTA1D10-100C	
12xD	A	9.900	11.398	11.538	13.678	2.280	1.00	Yes	HTA1A12-100F	
12xD	A	9.900	11.398	11.538	13.678	2.280	1.00	No	HTA1A12-100C	
12xD	B	9.900	11.398	11.538	13.678	2.280	1.00	Yes	HTA1B12-100F	
12xD	B	9.900	11.398	11.538	13.678	2.280	1.00	No	HTA1B12-100C	
12xD	C	9.900	11.398	11.538	13.678	2.280	1.00	Yes	HTA1C12-100F	
12xD	C	9.900	11.398	11.538	13.678	2.280	1.00	No	HTA1C12-100C	
12xD	D	9.900	11.398	11.538	13.678	2.280	1.00	Yes	HTA1D12-100F	
12xD	D	9.900	11.398	11.538	13.678	2.280	1.00	No	HTA1D12-100C	
15xD	A	12.375	13.873	14.013	16.153	2.280	1.00	Yes	HTA1A15-100F	
15xD	A	12.375	13.873	14.013	16.153	2.280	1.00	No	HTA1A15-100C	
15xD	B	12.375	13.873	14.013	16.153	2.280	1.00	Yes	HTA1B15-100F	
15xD	B	12.375	13.873	14.013	16.153	2.280	1.00	No	HTA1B15-100C	
15xD	C	12.375	13.873	14.013	16.153	2.280	1.00	Yes	HTA1C15-100F	
15xD	C	12.375	13.873	14.013	16.153	2.280	1.00	No	HTA1C15-100C	
15xD	D	12.375	13.873	14.013	16.153	2.280	1.00	Yes	HTA1D15-100F	
15xD	D	12.375	13.873	14.013	16.153	2.280	1.00	No	HTA1D15-100C	

1

A

DRILLING

B

BORING

C

REAMING

D

BURNISHING

F

THREADING

X

SPECIALS

Connection Accessories

	Insert Screws	Nylon Locking Screws	Insert Driver	Preset Torque Hand Driver	Replacement Tips	Admissible Tightening Torque*
A/B	7375-IP9-1	7375N-IP9-1	8IP-9	8IP-9TL	8IP-9B	305 N-cm (27.0 in-lbs)
C/D	739-IP9-1	739N-IP9-1	8IP-9	8IP-9TL	8IP-9B	305 N-cm (27.0 in-lbs)

*Tightening torques are calculated with a friction coefficient of $\mu = 0.14$ and develop 90% of ultimate yield strength

WARNING Refer to Speed and Feed charts for recommended adjustments to speeds and feeds. Refer to page A25: 68 for deep hole drilling guidelines in this section of the catalog. Visit www.alliedmachine.com/DeepHoleGuidelines for the most up-to-date information and procedures. Factory technical assistance is available for your specific applications through our Application Engineering department. email: engineering.eu@alliedmachine.com

A25: 58 - 65 A25: 22 - 25 A25: 26 - 29

Key on A25: 1





= Metric (mm)
 = Imperial (in)

Screws sold in multiples of 10

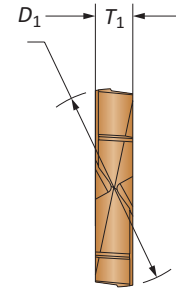
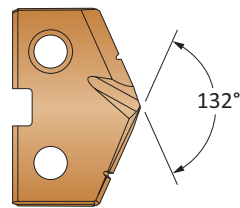
T-A Pro Carbide Drill Inserts

2 Series | Diameter Range: 24.38mm - 35.04mm (0.960" - 1.379")



Series	Insert		Fractional Equivalent	T ₁				
	D ₁ mm	D ₁ inch			Part No.	Part No.	Part No.	Part No.
2-A	24.40	0.9606		3/16	P	K	N	M
2-A	24.50	0.9646		3/16	TAP2-24.40	TAK2-24.40	TAN2-24.40	TAM2-24.40
2-A	24.61	0.9689	31/32	3/16	TAP2-24.50	TAK2-24.50	TAN2-24.50	TAM2-24.50
2-A	24.70	0.9724		3/16	TAP2-24.61	TAK2-24.61	TAN2-24.61	TAM2-24.61
2-A	24.80	0.9764		3/16	TAP2-24.70	TAK2-24.70	TAN2-24.70	TAM2-24.70
2-A	24.80	0.9764		3/16	TAP2-24.80	TAK2-24.80	TAN2-24.80	TAM2-24.80
2-A	24.90	0.9803		3/16	TAP2-24.90	TAK2-24.90	TAN2-24.90	TAM2-24.90
2-A	25.00	0.9843	63/64	3/16	TAP2-25.00	TAK2-25.00	TAN2-25.00	TAM2-25.00
2-A	25.10	0.9882		3/16	TAP2-25.10	TAK2-25.10	TAN2-25.10	TAM2-25.10
2-A	25.20	0.9921		3/16	TAP2-25.20	TAK2-25.20	TAN2-25.20	TAM2-25.20
2-A	25.30	0.9961		3/16	TAP2-25.30	TAK2-25.30	TAN2-25.30	TAM2-25.30

Inserts sold in multiples of 2

Sub Series Holders (A, B, C, D)

Sub series holders are recommended when running carbide inserts toward the upper end of the series drill range, as well as in tougher applications requiring more insert support and holder strength. **NOTE:** Only specified sub series inserts should be used with equivalent or smaller sub series holders.



A Series Insert +
A Series Holder



C Series Insert +
A Series Holder



C Series Insert +
C Series Holder



A Series Insert +
C Series Holder

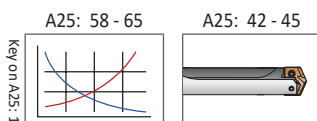





Sizes not shown are available upon request.
When ordering, please follow the example below:

Metric:	13.16mm, Steel, 0 series = use Part No. TAP0-13.16
Imperial:	0.5180", Steel, 0 series = use Part No. TAP0-13.16

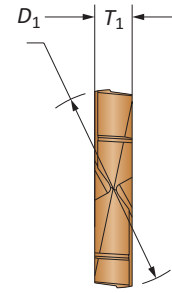
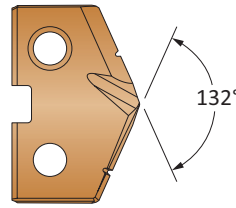
T-A Pro Carbide Drill Inserts

2 Series | Diameter Range: 24.38mm - 35.04mm (0.960" - 1.379")



Series	Insert							
	D_1 mm	D_1 inch	Fractional Equivalent	T_1	Part No. P	Part No. K	Part No. N	Part No. M
2-B	25.40	1.0000	1	3/16	TAP2-25.40	TAK2-25.40	TAN2-25.40	TAM2-25.40
2-B	25.50	1.0039		3/16	TAP2-25.50	TAK2-25.50	TAN2-25.50	TAM2-25.50
2-B	25.60	1.0079		3/16	TAP2-25.60	TAK2-25.60	TAN2-25.60	TAM2-25.60
2-B	25.70	1.0118		3/16	TAP2-25.70	TAK2-25.70	TAN2-25.70	TAM2-25.70
2-B	25.78	1.0150		3/16	TAP2-25.78	TAK2-25.78	TAN2-25.78	TAM2-25.78
2-B	25.90	1.0197		3/16	TAP2-25.90	TAK2-25.90	TAN2-25.90	TAM2-25.90
2-B	26.00	1.0236		3/16	TAP2-26.00	TAK2-26.00	TAN2-26.00	TAM2-26.00
2-B	26.10	1.0276		3/16	TAP2-26.10	TAK2-26.10	TAN2-26.10	TAM2-26.10
2-B	26.20	1.0315	1-1/32	3/16	TAP2-26.20	TAK2-26.20	TAN2-26.20	TAM2-26.20
2-B	26.30	1.0354		3/16	TAP2-26.30	TAK2-26.30	TAN2-26.30	TAM2-26.30
2-B	26.40	1.0394		3/16	TAP2-26.40	TAK2-26.40	TAN2-26.40	TAM2-26.40
2-B	26.50	1.0433		3/16	TAP2-26.50	TAK2-26.50	TAN2-26.50	TAM2-26.50
2-B	26.57	1.0461		3/16	TAP2-26.57	TAK2-26.57	TAN2-26.57	TAM2-26.57
2-B	26.59	1.0469	1-3/64	3/16	TAP2-26.59	TAK2-26.59	TAN2-26.59	TAM2-26.59
2-B	26.60	1.0472		3/16	TAP2-26.60	TAK2-26.60	TAN2-26.60	TAM2-26.60
2-B	26.70	1.0512		3/16	TAP2-26.70	TAK2-26.70	TAN2-26.70	TAM2-26.70
2-B	26.80	1.0551		3/16	TAP2-26.80	TAK2-26.80	TAN2-26.80	TAM2-26.80
2-B	26.90	1.0591		3/16	TAP2-26.90	TAK2-26.90	TAN2-26.90	TAM2-26.90
2-B	26.99	1.0626	1-1/16	3/16	TAP2-26.99	TAK2-26.99	TAN2-26.99	TAM2-26.99
2-B	27.00	1.0630		3/16	TAP2-27.00	TAK2-27.00	TAN2-27.00	TAM2-27.00
2-B	27.10	1.0669		3/16	TAP2-27.10	TAK2-27.10	TAN2-27.10	TAM2-27.10
2-B	27.20	1.0709		3/16	TAP2-27.20	TAK2-27.20	TAN2-27.20	TAM2-27.20
2-B	27.30	1.0748		3/16	TAP2-27.30	TAK2-27.30	TAN2-27.30	TAM2-27.30
2-B	27.40	1.0787		3/16	TAP2-27.40	TAK2-27.40	TAN2-27.40	TAM2-27.40
2-B	27.50	1.0827		3/16	TAP2-27.50	TAK2-27.50	TAN2-27.50	TAM2-27.50
2-B	27.60	1.0866		3/16	TAP2-27.60	TAK2-27.60	TAN2-27.60	TAM2-27.60
2-B	27.70	1.0906		3/16	TAP2-27.70	TAK2-27.70	TAN2-27.70	TAM2-27.70
2-B	27.78	1.0937	1-3/32	3/16	TAP2-27.78	TAK2-27.78	TAN2-27.78	TAM2-27.78
2-B	27.90	1.0984		3/16	TAP2-27.90	TAK2-27.90	TAN2-27.90	TAM2-27.90
2-B	28.00	1.1024		3/16	TAP2-28.00	TAK2-28.00	TAN2-28.00	TAM2-28.00
2-B	28.10	1.1063		3/16	TAP2-28.10	TAK2-28.10	TAN2-28.10	TAM2-28.10
2-B	28.17	1.1091	1-7/64	3/16	TAP2-28.17	TAK2-28.17	TAN2-28.17	TAM2-28.17
2-B	28.20	1.1102		3/16	TAP2-28.20	TAK2-28.20	TAN2-28.20	TAM2-28.20
2-B	28.30	1.1142		3/16	TAP2-28.30	TAK2-28.30	TAN2-28.30	TAM2-28.30
2-B	28.40	1.1181		3/16	TAP2-28.40	TAK2-28.40	TAN2-28.40	TAM2-28.40

Inserts sold in multiples of 2

Sub Series Holders (A, B, C, D)

Sub series holders are recommended when running carbide inserts toward the upper end of the series drill range, as well as in tougher applications requiring more insert support and holder strength. **NOTE:** Only specified sub series inserts should be used with equivalent or smaller sub series holders.



A Series Insert + A Series Holder



C Series Insert + A Series Holder



C Series Insert + C Series Holder



A Series Insert + C Series Holder

A25: 58 - 65

A25: 42 - 45

Key on A25: 1

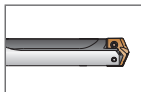
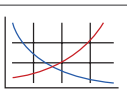

Sizes not shown are available upon request.

When ordering, please follow the example below:

Metric:	13.16mm, Steel, 0 series = use Part No. TAP0-13.16
Imperial:	0.5180", Steel, 0 series = use Part No. TAP0-13.16

A

DRILLING

B

BORING

C

REAMING

D

BURNISHING

F

THREADING





X

SPECIALS

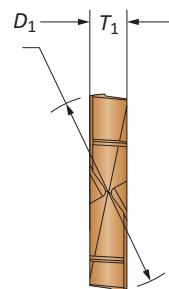
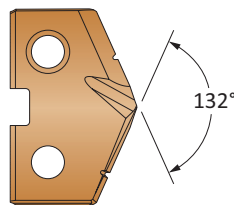
T-A Pro Carbide Drill Inserts

2 Series | Diameter Range: 24.38mm - 35.04mm (0.960" - 1.379")



Series	Insert							
	D ₁ mm	D ₁ inch	Fractional Equivalent	T ₁	Part No. P	Part No. K	Part No. N	Part No. M
2-C	28.50	1.1220		3/16	TAP2-28.50	TAK2-28.50	TAN2-28.50	TAM2-28.50
2-C	28.58	1.1252	1-1/8	3/16	TAP2-28.58	TAK2-28.58	TAN2-28.58	TAM2-28.58
2-C	28.70	1.1299		3/16	TAP2-28.70	TAK2-28.70	TAN2-28.70	TAM2-28.70
2-C	28.80	1.1339		3/16	TAP2-28.80	TAK2-28.80	TAN2-28.80	TAM2-28.80
2-C	28.90	1.1378		3/16	TAP2-28.90	TAK2-28.90	TAN2-28.90	TAM2-28.90
2-C	29.00	1.1417		3/16	TAP2-29.00	TAK2-29.00	TAN2-29.00	TAM2-29.00
2-C	29.10	1.1457		3/16	TAP2-29.10	TAK2-29.10	TAN2-29.10	TAM2-29.10
2-C	29.20	1.1496		3/16	TAP2-29.20	TAK2-29.20	TAN2-29.20	TAM2-29.20
2-C	29.30	1.1535		3/16	TAP2-29.30	TAK2-29.30	TAN2-29.30	TAM2-29.30
2-C	29.37	1.1563	1-5/32	3/16	TAP2-29.37	TAK2-29.37	TAN2-29.37	TAM2-29.37
2-C	29.40	1.1575		3/16	TAP2-29.40	TAK2-29.40	TAN2-29.40	TAM2-29.40
2-C	29.50	1.1614		3/16	TAP2-29.50	TAK2-29.50	TAN2-29.50	TAM2-29.50
2-C	29.60	1.1654		3/16	TAP2-29.60	TAK2-29.60	TAN2-29.60	TAM2-29.60
2-C	29.70	1.1693		3/16	TAP2-29.70	TAK2-29.70	TAN2-29.70	TAM2-29.70
2-C	29.80	1.1732		3/16	TAP2-29.80	TAK2-29.80	TAN2-29.80	TAM2-29.80
2-C	29.90	1.1772		3/16	TAP2-29.90	TAK2-29.90	TAN2-29.90	TAM2-29.90
2-C	30.00	1.1811		3/16	TAP2-30.00	TAK2-30.00	TAN2-30.00	TAM2-30.00
2-C	30.10	1.1850		3/16	TAP2-30.10	TAK2-30.10	TAN2-30.10	TAM2-30.10
2-C	30.16	1.1874	1-3/16	3/16	TAP2-30.16	TAK2-30.16	TAN2-30.16	TAM2-30.16
2-C	30.20	1.1890		3/16	TAP2-30.20	TAK2-30.20	TAN2-30.20	TAM2-30.20
2-C	30.30	1.1929		3/16	TAP2-30.30	TAK2-30.30	TAN2-30.30	TAM2-30.30
2-C	30.40	1.1969		3/16	TAP2-30.40	TAK2-30.40	TAN2-30.40	TAM2-30.40
2-C	30.50	1.2008		3/16	TAP2-30.50	TAK2-30.50	TAN2-30.50	TAM2-30.50
2-C	30.60	1.2047		3/16	TAP2-30.60	TAK2-30.60	TAN2-30.60	TAM2-30.60
2-C	30.70	1.2087		3/16	TAP2-30.70	TAK2-30.70	TAN2-30.70	TAM2-30.70
2-C	30.80	1.2126		3/16	TAP2-30.80	TAK2-30.80	TAN2-30.80	TAM2-30.80
2-C	30.90	1.2165		3/16	TAP2-30.90	TAK2-30.90	TAN2-30.90	TAM2-30.90
2-C	30.96	1.2189	1-7/32	3/16	TAP2-30.96	TAK2-30.96	TAN2-30.96	TAM2-30.96
2-C	31.00	1.2205		3/16	TAP2-31.00	TAK2-31.00	TAN2-31.00	TAM2-31.00
2-C	31.10	1.2244		3/16	TAP2-31.10	TAK2-31.10	TAN2-31.10	TAM2-31.10
2-C	31.20	1.2283		3/16	TAP2-31.20	TAK2-31.20	TAN2-31.20	TAM2-31.20
2-C	31.30	1.2323		3/16	TAP2-31.30	TAK2-31.30	TAN2-31.30	TAM2-31.30
2-C	31.40	1.2362		3/16	TAP2-31.40	TAK2-31.40	TAN2-31.40	TAM2-31.40
2-C	31.50	1.2402		3/16	TAP2-31.50	TAK2-31.50	TAN2-31.50	TAM2-31.50
2-C	31.60	1.2441		3/16	TAP2-31.60	TAK2-31.60	TAN2-31.60	TAM2-31.60

Inserts sold in multiples of 2

Sub Series Holders (A, B, C, D)

Sub series holders are recommended when running carbide inserts toward the upper end of the series drill range, as well as in tougher applications requiring more insert support and holder strength. **NOTE:** Only specified sub series inserts should be used with equivalent or smaller sub series holders.



A Series Insert + A Series Holder



C Series Insert + A Series Holder



C Series Insert + C Series Holder



A Series Insert + C Series Holder

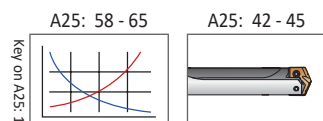



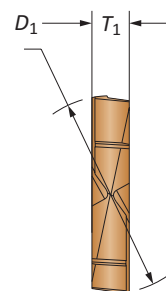
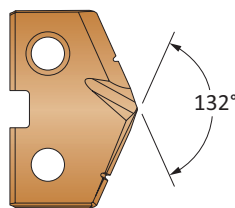

Sizes not shown are available upon request.	
When ordering, please follow the example below:	
Metric:	13.16mm, Steel, 0 series = use Part No. TAP0-13.16
Imperial:	0.5180", Steel, 0 series = use Part No. TAP0-13.16

T-A Pro Carbide Drill Inserts

2 Series | Diameter Range: 24.38mm - 35.04mm (0.960" - 1.379")



Series	Insert							
	D ₁ mm	D ₁ inch	Fractional Equivalent	T ₁	Part No. P	Part No. K	Part No. N	Part No. M
2-D	31.70	1.2480		3/16	TAP2-31.70	TAK2-31.70	TAN2-31.70	TAM2-31.70
2-D	31.75	1.2500	1-1/4	3/16	TAP2-31.75	TAK2-31.75	TAN2-31.75	TAM2-31.75
2-D	31.80	1.2520		3/16	TAP2-31.80	TAK2-31.80	TAN2-31.80	TAM2-31.80
2-D	31.90	1.2559		3/16	TAP2-31.90	TAK2-31.90	TAN2-31.90	TAM2-31.90
2-D	32.00	1.2598		3/16	TAP2-32.00	TAK2-32.00	TAN2-32.00	TAM2-32.00
2-D	32.10	1.2638		3/16	TAP2-32.10	TAK2-32.10	TAN2-32.10	TAM2-32.10
2-D	32.15	1.2657	1-17/64	3/16	TAP2-32.15	TAK2-32.15	TAN2-32.15	TAM2-32.15
2-D	32.20	1.2677		3/16	TAP2-32.20	TAK2-32.20	TAN2-32.20	TAM2-32.20
2-D	32.30	1.2717		3/16	TAP2-32.30	TAK2-32.30	TAN2-32.30	TAM2-32.30
2-D	32.40	1.2756		3/16	TAP2-32.40	TAK2-32.40	TAN2-32.40	TAM2-32.40
2-D	32.50	1.2795		3/16	TAP2-32.50	TAK2-32.50	TAN2-32.50	TAM2-32.50
2-D	32.55	1.2815	1-9/32	3/16	TAP2-32.55	TAK2-32.55	TAN2-32.55	TAM2-32.55
2-D	32.60	1.2835		3/16	TAP2-32.60	TAK2-32.60	TAN2-32.60	TAM2-32.60
2-D	32.70	1.2874		3/16	TAP2-32.70	TAK2-32.70	TAN2-32.70	TAM2-32.70
2-D	32.80	1.2913		3/16	TAP2-32.80	TAK2-32.80	TAN2-32.80	TAM2-32.80
2-D	32.90	1.2953		3/16	TAP2-32.90	TAK2-32.90	TAN2-32.90	TAM2-32.90
2-D	33.00	1.2992		3/16	TAP2-33.00	TAK2-33.00	TAN2-33.00	TAM2-33.00
2-D	33.10	1.3031		3/16	TAP2-33.10	TAK2-33.10	TAN2-33.10	TAM2-33.10
2-D	33.20	1.3071		3/16	TAP2-33.20	TAK2-33.20	TAN2-33.20	TAM2-33.20
2-D	33.30	1.3110		3/16	TAP2-33.30	TAK2-33.30	TAN2-33.30	TAM2-33.30
2-D	33.34	1.3126	1-5/16	3/16	TAP2-33.34	TAK2-33.34	TAN2-33.34	TAM2-33.34
2-D	33.40	1.3150		3/16	TAP2-33.40	TAK2-33.40	TAN2-33.40	TAM2-33.40
2-D	33.50	1.3189		3/16	TAP2-33.50	TAK2-33.50	TAN2-33.50	TAM2-33.50
2-D	33.60	1.3228		3/16	TAP2-33.60	TAK2-33.60	TAN2-33.60	TAM2-33.60
2-D	33.70	1.3268		3/16	TAP2-33.70	TAK2-33.70	TAN2-33.70	TAM2-33.70
2-D	33.80	1.3307		3/16	TAP2-33.80	TAK2-33.80	TAN2-33.80	TAM2-33.80
2-D	33.90	1.3346		3/16	TAP2-33.90	TAK2-33.90	TAN2-33.90	TAM2-33.90
2-D	34.00	1.3386		3/16	TAP2-34.00	TAK2-34.00	TAN2-34.00	TAM2-34.00
2-D	34.10	1.3425		3/16	TAP2-34.10	TAK2-34.10	TAN2-34.10	TAM2-34.10
2-D	34.13	1.3437	1-11/32	3/16	TAP2-34.13	TAK2-34.13	TAN2-34.13	TAM2-34.13
2-D	34.20	1.3465		3/16	TAP2-34.20	TAK2-34.20	TAN2-34.20	TAM2-34.20
2-D	34.30	1.3504		3/16	TAP2-34.30	TAK2-34.30	TAN2-34.30	TAM2-34.30
2-D	34.40	1.3543		3/16	TAP2-34.40	TAK2-34.40	TAN2-34.40	TAM2-34.40
2-D	34.50	1.3583		3/16	TAP2-34.50	TAK2-34.50	TAN2-34.50	TAM2-34.50
2-D	34.60	1.3622		3/16	TAP2-34.60	TAK2-34.60	TAN2-34.60	TAM2-34.60
2-D	34.70	1.3661		3/16	TAP2-34.70	TAK2-34.70	TAN2-34.70	TAM2-34.70
2-D	34.80	1.3701		3/16	TAP2-34.80	TAK2-34.80	TAN2-34.80	TAM2-34.80
2-D	34.90	1.3740		3/16	TAP2-34.90	TAK2-34.90	TAN2-34.90	TAM2-34.90
2-D	34.93	1.3752	1-3/8	3/16	TAP2-34.93	TAK2-34.93	TAN2-34.93	TAM2-34.93
2-D	35.00	1.3780		3/16	TAP2-35.00	TAK2-35.00	TAN2-35.00	TAM2-35.00

Inserts sold in multiples of 2

Sub Series Holders (A, B, C, D)

Sub series holders are recommended when running carbide inserts toward the upper end of the series drill range, as well as in tougher applications requiring more insert support and holder strength. **NOTE:** Only specified sub series inserts should be used with equivalent or smaller sub series holders.



A Series Insert + A Series Holder



C Series Insert + A Series Holder



C Series Insert + C Series Holder



A Series Insert + C Series Holder

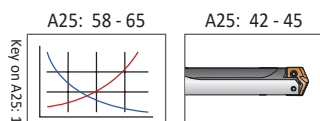

Sizes not shown are available upon request.	
When ordering, please follow the example below:	
Metric:	13.16mm, Steel, 0 series = use Part No. TAP0-13.16
Imperial:	0.5180", Steel, 0 series = use Part No. TAP0-13.16

T-A Pro HSS Drill Inserts

2 Series | Diameter Range: 24.38mm - 35.04mm (0.960" - 1.379")

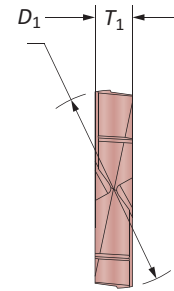
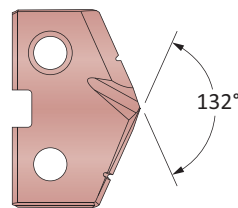

Series	D_1 mm	D_1 inch	Fractional Equivalent	T_1	 Part No.
					X
2-A	24.40	0.9606		3/16	TAX2-24.40
2-A	24.50	0.9646		3/16	TAX2-24.50
2-A	24.61	0.9689	31/32	3/16	TAX2-24.61
2-A	24.70	0.9724		3/16	TAX2-24.70
2-A	24.80	0.9764		3/16	TAX2-24.80
2-A	24.90	0.9803		3/16	TAX2-24.90
2-A	25.00	0.9843	63/64	3/16	TAX2-25.00
2-A	25.10	0.9882		3/16	TAX2-25.10
2-A	25.20	0.9921		3/16	TAX2-25.20
2-A	25.30	0.9961		3/16	TAX2-25.30

Inserts sold in multiples of 2

Sub Series Holders (A, B, C, D)

Sub series holders are recommended when running carbide inserts toward the upper end of the series drill range, as well as in tougher applications requiring more insert support and holder strength. **NOTE:** Only specified sub series inserts should be used with equivalent or smaller sub series holders.



A Series Insert +
A Series Holder



C Series Insert +
A Series Holder



C Series Insert +
C Series Holder



A Series Insert +
C Series Holder

A25: 58 - 65

A25: 42 - 45

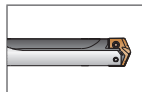
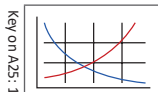



Sizes not shown are available upon request.
When ordering, please follow the example below:

Metric:	13.16mm, Steel, 0 series = use Part No. TAP0-13.16
Imperial:	0.5180", Steel, 0 series = use Part No. TAP0-13.16

T-A Pro HSS Drill Inserts

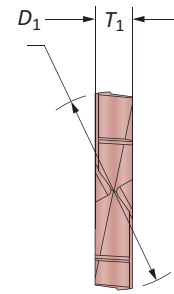
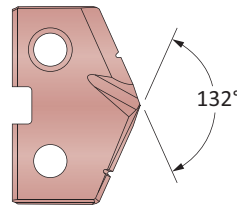
2 Series | Diameter Range: 24.38mm - 35.04mm (0.960" - 1.379")



Series	D ₁ mm	D ₁ inch	Fractional Equivalent	T ₁	 Part No.
					X
2-B	25.40	1.0000	1	3/16	TAX2-25.40
2-B	25.50	1.0039		3/16	TAX2-25.50
2-B	25.60	1.0079		3/16	TAX2-25.60
2-B	25.70	1.0118		3/16	TAX2-25.70
2-B	25.78	1.0150		3/16	TAX2-25.78
2-B	25.90	1.0197		3/16	TAX2-25.90
2-B	26.00	1.0236		3/16	TAX2-26.00
2-B	26.10	1.0276		3/16	TAX2-26.10
2-B	26.20	1.0315	1-1/32	3/16	TAX2-26.20
2-B	26.30	1.0354		3/16	TAX2-26.30
2-B	26.40	1.0394		3/16	TAX2-26.40
2-B	26.50	1.0433		3/16	TAX2-26.50
2-B	26.57	1.0461		3/16	TAX2-26.57
2-B	26.59	1.0469	1-3/64	3/16	TAX2-26.59
2-B	26.60	1.0472		3/16	TAX2-26.60
2-B	26.70	1.0512		3/16	TAX2-26.70
2-B	26.80	1.0551		3/16	TAX2-26.80
2-B	26.90	1.0591		3/16	TAX2-26.90
2-B	26.99	1.0626	1-1/16	3/16	TAX2-26.99
2-B	27.00	1.0630		3/16	TAX2-27.00
2-B	27.10	1.0669		3/16	TAX2-27.10
2-B	27.20	1.0709		3/16	TAX2-27.20
2-B	27.30	1.0748		3/16	TAX2-27.30
2-B	27.40	1.0787		3/16	TAX2-27.40
2-B	27.50	1.0827		3/16	TAX2-27.50
2-B	27.60	1.0866		3/16	TAX2-27.60
2-B	27.70	1.0906		3/16	TAX2-27.70
2-B	27.78	1.0937	1-3/32	3/16	TAX2-27.78
2-B	27.90	1.0984		3/16	TAX2-27.90
2-B	28.00	1.1024		3/16	TAX2-28.00
2-B	28.10	1.1063		3/16	TAX2-28.10
2-B	28.17	1.1091	1-7/64	3/16	TAX2-28.17
2-B	28.20	1.1102		3/16	TAX2-28.20
2-B	28.30	1.1142		3/16	TAX2-28.30
2-B	28.40	1.1181		3/16	TAX2-28.40

Inserts sold in multiples of 2

Sub Series Holders (A, B, C, D)

Sub series holders are recommended when running carbide inserts toward the upper end of the series drill range, as well as in tougher applications requiring more insert support and holder strength. **NOTE:** Only specified sub series inserts should be used with equivalent or smaller sub series holders.



A Series Insert +
A Series Holder



C Series Insert +
A Series Holder



C Series Insert +
C Series Holder



A Series Insert +
C Series Holder

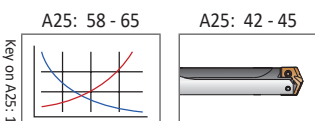

Sizes not shown are available upon request.
When ordering, please follow the example below:

Metric:	13.16mm, Steel, 0 series = use Part No. TAP0-13.16
Imperial:	0.5180", Steel, 0 series = use Part No. TAP0-13.16

A
DRILLING
B
BORING
C
REAMING
D
BURISHING
E
THREADING
X
SPECIALS

T-A Pro HSS Drill Inserts

2 Series | Diameter Range: 24.38mm - 35.04mm (0.960" - 1.379")

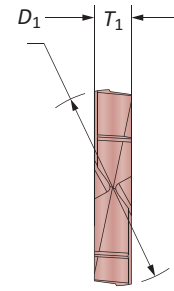
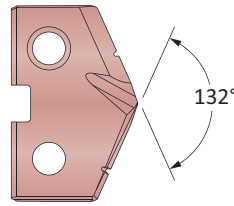

Series	D ₁ mm	D ₁ inch	Fractional Equivalent	T ₁	 Part No. X
					Insert
2-C	28.50	1.1220		3/16	TAX2-28.50
2-C	28.58	1.1252	1-1/8	3/16	TAX2-28.58
2-C	28.70	1.1299		3/16	TAX2-28.70
2-C	28.80	1.1339		3/16	TAX2-28.80
2-C	28.90	1.1378		3/16	TAX2-28.90
2-C	29.00	1.1417		3/16	TAX2-29.00
2-C	29.10	1.1457		3/16	TAX2-29.10
2-C	29.20	1.1496		3/16	TAX2-29.20
2-C	29.30	1.1535		3/16	TAX2-29.30
2-C	29.37	1.1563	1-5/32	3/16	TAX2-29.37
2-C	29.40	1.1575		3/16	TAX2-29.40
2-C	29.50	1.1614		3/16	TAX2-29.50
2-C	29.60	1.1654		3/16	TAX2-29.60
2-C	29.70	1.1693		3/16	TAX2-29.70
2-C	29.80	1.1732		3/16	TAX2-29.80
2-C	29.90	1.1772		3/16	TAX2-29.90
2-C	30.00	1.1811		3/16	TAX2-30.00
2-C	30.10	1.1850		3/16	TAX2-30.10
2-C	30.16	1.1874	1-3/16	3/16	TAX2-30.16
2-C	30.20	1.1890		3/16	TAX2-30.20
2-C	30.30	1.1929		3/16	TAX2-30.30
2-C	30.40	1.1969		3/16	TAX2-30.40
2-C	30.50	1.2008		3/16	TAX2-30.50
2-C	30.60	1.2047		3/16	TAX2-30.60
2-C	30.70	1.2087		3/16	TAX2-30.70
2-C	30.80	1.2126		3/16	TAX2-30.80
2-C	30.90	1.2165		3/16	TAX2-30.90
2-C	30.96	1.2189	1-7/32	3/16	TAX2-30.96
2-C	31.00	1.2205		3/16	TAX2-31.00
2-C	31.10	1.2244		3/16	TAX2-31.10
2-C	31.20	1.2283		3/16	TAX2-31.20
2-C	31.30	1.2323		3/16	TAX2-31.30
2-C	31.40	1.2362		3/16	TAX2-31.40
2-C	31.50	1.2402		3/16	TAX2-31.50
2-C	31.60	1.2441		3/16	TAX2-31.60

Inserts sold in multiples of 2

Sub Series Holders (A, B, C, D)

Sub series holders are recommended when running carbide inserts toward the upper end of the series drill range, as well as in tougher applications requiring more insert support and holder strength. **NOTE:** Only specified sub series inserts should be used with equivalent or smaller sub series holders.



A Series Insert +
A Series Holder



C Series Insert +
A Series Holder



C Series Insert +
C Series Holder



A Series Insert +
C Series Holder

A25: 58 - 65

A25: 42 - 45

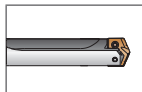
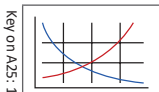

Sizes not shown are available upon request.

When ordering, please follow the example below:

Metric:	13.16mm, Steel, 0 series = use Part No. TAP0-13.16
Imperial:	0.5180", Steel, 0 series = use Part No. TAP0-13.16

T-A Pro HSS Drill Inserts

2 Series | Diameter Range: 24.38mm - 35.04mm (0.960" - 1.379")

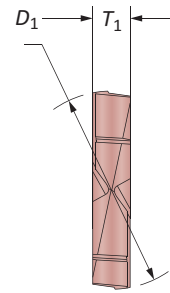
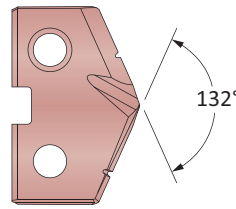

Series	Insert				Part No. X
	D ₁ mm	D ₁ inch	Fractional Equivalent	T ₁	
2-D	31.70	1.2480		3/16	TAX2-31.70
2-D	31.75	1.2500	1-1/4	3/16	TAX2-31.75
2-D	31.80	1.2520		3/16	TAX2-31.80
2-D	31.90	1.2559		3/16	TAX2-31.90
2-D	32.00	1.2598		3/16	TAX2-32.00
2-D	32.10	1.2638		3/16	TAX2-32.10
2-D	32.15	1.2657	1-17/64	3/16	TAX2-32.15
2-D	32.20	1.2677		3/16	TAX2-32.20
2-D	32.30	1.2717		3/16	TAX2-32.30
2-D	32.40	1.2756		3/16	TAX2-32.40
2-D	32.50	1.2795		3/16	TAX2-32.50
2-D	32.55	1.2815	1-9/32	3/16	TAX2-32.55
2-D	32.60	1.2835		3/16	TAX2-32.60
2-D	32.70	1.2874		3/16	TAX2-32.70
2-D	32.80	1.2913		3/16	TAX2-32.80
2-D	32.90	1.2953		3/16	TAX2-32.90
2-D	33.00	1.2992		3/16	TAX2-33.00
2-D	33.10	1.3031		3/16	TAX2-33.10
2-D	33.20	1.3071		3/16	TAX2-33.20
2-D	33.30	1.3110		3/16	TAX2-33.30
2-D	33.34	1.3126	1-5/16	3/16	TAX2-33.34
2-D	33.40	1.3150		3/16	TAX2-33.40
2-D	33.50	1.3189		3/16	TAX2-33.50
2-D	33.60	1.3228		3/16	TAX2-33.60
2-D	33.70	1.3268		3/16	TAX2-33.70
2-D	33.80	1.3307		3/16	TAX2-33.80
2-D	33.90	1.3346		3/16	TAX2-33.90
2-D	34.00	1.3386		3/16	TAX2-34.00
2-D	34.10	1.3425		3/16	TAX2-34.10
2-D	34.13	1.3437	1-11/32	3/16	TAX2-34.13
2-D	34.20	1.3465		3/16	TAX2-34.20
2-D	34.30	1.3504		3/16	TAX2-34.30
2-D	34.40	1.3543		3/16	TAX2-34.40
2-D	34.50	1.3583		3/16	TAX2-34.50
2-D	34.60	1.3622		3/16	TAX2-34.60
2-D	34.70	1.3661		3/16	TAX2-34.70
2-D	34.80	1.3701		3/16	TAX2-34.80
2-D	34.90	1.3740		3/16	TAX2-34.90
2-D	34.93	1.3752	1-3/8	3/16	TAX2-34.93
2-D	35.00	1.3780		3/16	TAX2-35.00

Inserts sold in multiples of 2

Sub Series Holders (A, B, C, D)

Sub series holders are recommended when running carbide inserts toward the upper end of the series drill range, as well as in tougher applications requiring more insert support and holder strength. **NOTE:** Only specified sub series inserts should be used with equivalent or smaller sub series holders.



A Series Insert +
A Series Holder



C Series Insert +
A Series Holder



C Series Insert +
C Series Holder



A Series Insert +
C Series Holder

A25: 58 - 65

A25: 42 - 45

Key on A25: 1

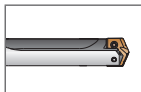
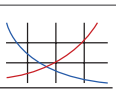

Sizes not shown are available upon request.

When ordering, please follow the example below:

Metric:	13.16mm, Steel, 0 series = use Part No. TAP0-13.16
Imperial:	0.5180", Steel, 0 series = use Part No. TAP0-13.16

A
DRILLING
B
BORING
C
REAMING
D
BURISHING
E
THREADING
X
SPECIALS

2

 DRILLING | T-A Pro® High Penetration Replaceable Insert Drilling System

T-A Pro Drill Holders

2 Series Metric | Diameter Range: 24.38mm - 35.04mm



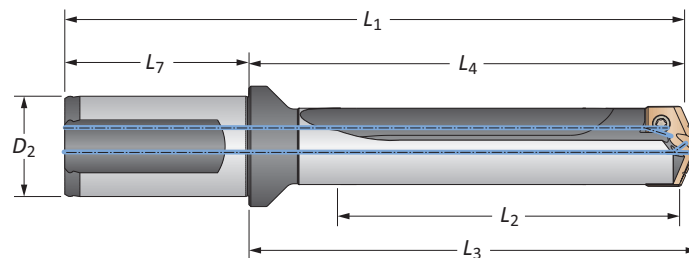

Body						Shank				Part No
Length	Sub Series	L ₂	L ₄	L ₃	L ₁	L ₇	D ₂	Flat		
STUB	A	29.7	75.0	78.6	132.9	57.9	32	Yes	HTA2A01-32FM	
STUB	A	29.7	75.0	78.6	132.9	57.9	32	No	HTA2A01-32CM	
STUB	B	29.7	75.0	78.6	132.9	57.9	32	Yes	HTA2B01-32FM	
STUB	B	29.7	75.0	78.6	132.9	57.9	32	No	HTA2B01-32CM	
STUB	C	29.7	75.0	78.6	132.9	57.9	32	Yes	HTA2C01-32FM	
STUB	C	29.7	75.0	78.6	132.9	57.9	32	No	HTA2C01-32CM	
STUB	D	29.7	75.0	78.6	132.9	57.9	32	Yes	HTA2D01-32FM	
STUB	D	29.7	75.0	78.6	132.9	57.9	32	No	HTA2D01-32CM	
3xD	A	89.2	137.4	141.0	195.4	57.9	32	Yes	HTA2A03-32FM	
3xD	A	89.2	137.4	141.0	195.4	57.9	32	No	HTA2A03-32CM	
3xD	B	89.2	137.4	141.0	195.4	57.9	32	Yes	HTA2B03-32FM	
3xD	B	89.2	137.4	141.0	195.4	57.9	32	No	HTA2B03-32CM	
3xD	C	89.2	137.4	141.0	195.4	57.9	32	Yes	HTA2C03-32FM	
3xD	C	89.2	137.4	141.0	195.4	57.9	32	No	HTA2C03-32CM	
3xD	D	89.2	137.4	141.0	195.4	57.9	32	Yes	HTA2D03-32FM	
3xD	D	89.2	137.4	141.0	195.4	57.9	32	No	HTA2D03-32CM	
5xD	A	148.7	196.9	200.5	254.8	57.9	32	Yes	HTA2A05-32FM	
5xD	A	148.7	196.9	200.5	254.8	57.9	32	No	HTA2A05-32CM	
5xD	B	148.7	196.9	200.5	254.8	57.9	32	Yes	HTA2B05-32FM	
5xD	B	148.7	196.9	200.5	254.8	57.9	32	No	HTA2B05-32CM	
5xD	C	148.7	196.9	200.5	254.8	57.9	32	Yes	HTA2C05-32FM	
5xD	C	148.7	196.9	200.5	254.8	57.9	32	No	HTA2C05-32CM	
5xD	D	148.7	196.9	200.5	254.8	57.9	32	Yes	HTA2D05-32FM	
5xD	D	148.7	196.9	200.5	254.8	57.9	32	No	HTA2D05-32CM	
7xD	A	208.2	256.4	260.0	314.3	57.9	32	Yes	HTA2A07-32FM	
7xD	A	208.2	256.4	260.0	314.3	57.9	32	No	HTA2A07-32CM	
7xD	B	208.2	256.4	260.0	314.3	57.9	32	Yes	HTA2B07-32FM	
7xD	B	208.2	256.4	260.0	314.3	57.9	32	No	HTA2B07-32CM	
7xD	C	208.2	256.4	260.0	314.3	57.9	32	Yes	HTA2C07-32FM	
7xD	C	208.2	256.4	260.0	314.3	57.9	32	No	HTA2C07-32CM	
7xD	D	208.2	256.4	260.0	314.3	57.9	32	Yes	HTA2D07-32FM	
7xD	D	208.2	256.4	260.0	314.3	57.9	32	No	HTA2D07-32CM	

Connection Accessories

Insert Screws	Nylon Locking Screws	Insert Driver	Preset Torque Hand Driver	Replacement Tips	Admissible Tightening Torque*
7495-IP15-1	7495N-IP15-1	8IP-15	8IP-15TL	8IP-15B	690 N-cm (61.0 in-lbs)

*Tightening torques are calculated with a friction coefficient of $\mu = 0.14$ and develop 90% of ultimate yield strength

WARNING Refer to Speed and Feed charts for recommended adjustments to speeds and feeds. Refer to page A25: 68 for deep hole drilling guidelines in this section of the catalog. Visit www.alliedmachine.com/DeepHoleGuidelines for the most up-to-date information and procedures. Factory technical assistance is available for your specific applications through our Application Engineering department.
email: engineering.eu@alliedmachine.com

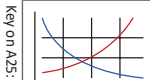
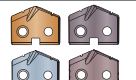
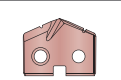
A25: 58 - 65  A25: 34 - 37  A25: 38 - 41 

Key on A25: 1

 = Metric (mm)
 = Imperial (in)

Screws sold in multiples of 10

A25: 42

www.alliedmachine.com | +44 (0) 1384 400 900 | enquiries.eu@alliedmachine.com

A DRILLING

B BORING

C REAMING

D BURINISHING

E THREADING

X SPECIALS

T-A Pro Drill Holders

2 Series Metric | Diameter Range: 24.38mm - 35.04mm

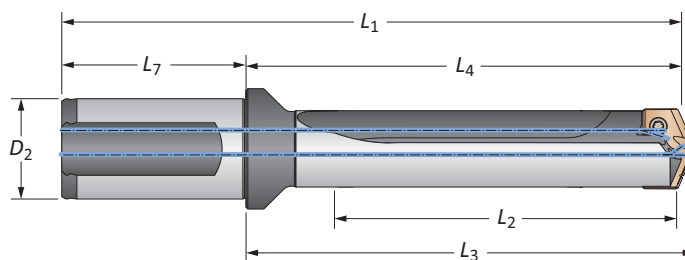

Length	Sub Series	Body				Shank				Part No
		L ₂	L ₄	L ₃	L ₁	L ₇	D ₂	Flat		
10xD	A	297.4	345.6	349.2	403.6	57.9	32	Yes	HTA2A10-32FM	
10xD	A	297.4	345.6	349.2	403.6	57.9	32	No	HTA2A10-32CM	
10xD	B	297.4	345.6	349.2	403.6	57.9	32	Yes	HTA2B10-32FM	
10xD	B	297.4	345.6	349.2	403.6	57.9	32	No	HTA2B10-32CM	
10xD	C	297.4	345.6	349.2	403.6	57.9	32	Yes	HTA2C10-32FM	
10xD	C	297.4	345.6	349.2	403.6	57.9	32	No	HTA2C10-32CM	
10xD	D	297.4	345.6	349.2	403.6	57.9	32	Yes	HTA2D10-32FM	
10xD	D	297.4	345.6	349.2	403.6	57.9	32	No	HTA2D10-32CM	
12xD	A	356.9	405.1	408.7	463.0	57.9	32	Yes	HTA2A12-32FM	
12xD	A	356.9	405.1	408.7	463.0	57.9	32	No	HTA2A12-32CM	
12xD	B	356.9	405.1	408.7	463.0	57.9	32	Yes	HTA2B12-32FM	
12xD	B	356.9	405.1	408.7	463.0	57.9	32	No	HTA2B12-32CM	
12xD	C	356.9	405.1	408.7	463.0	57.9	32	Yes	HTA2C12-32FM	
12xD	C	356.9	405.1	408.7	463.0	57.9	32	No	HTA2C12-32CM	
12xD	D	356.9	405.1	408.7	463.0	57.9	32	Yes	HTA2D12-32FM	
12xD	D	356.9	405.1	408.7	463.0	57.9	32	No	HTA2D12-32CM	
15xD	A	446.2	494.4	497.9	552.3	57.9	32	Yes	HTA2A15-32FM	
15xD	A	446.2	494.4	497.9	552.3	57.9	32	No	HTA2A15-32CM	
15xD	B	446.2	494.4	497.9	552.3	57.9	32	Yes	HTA2B15-32FM	
15xD	B	446.2	494.4	497.9	552.3	57.9	32	No	HTA2B15-32CM	
15xD	C	446.2	494.4	497.9	552.3	57.9	32	Yes	HTA2C15-32FM	
15xD	C	446.2	494.4	497.9	552.3	57.9	32	No	HTA2C15-32CM	
15xD	D	446.2	494.4	497.9	552.3	57.9	32	Yes	HTA2D15-32FM	
15xD	D	446.2	494.4	497.9	552.3	57.9	32	No	HTA2D15-32CM	

mm

A

DRILLING

B

BORING

C

REAMING

D

BURNISHING

F

THREADING

X

SPECIALS

Connection Accessories

					Admissible Tightening Torque*
Insert Screws	Nylon Locking Screws	Insert Driver	Preset Torque Hand Driver	Replacement Tips	
7495-IP15-1	7495N-IP15-1	8IP-15	8IP-15TL	8IP-15B	690 N-cm (61.0 in-lbs)

*Tightening torques are calculated with a friction coefficient of $\mu = 0.14$ and develop 90% of ultimate yield strength

WARNING Refer to Speed and Feed charts for recommended adjustments to speeds and feeds. Refer to page A25: 68 for deep hole drilling guidelines in this section of the catalog. Visit www.alliedmachine.com/DeepHoleGuidelines for the most up-to-date information and procedures. Factory technical assistance is available for your specific applications through our Application Engineering department. email: engineering.eu@alliedmachine.com

A25: 58 - 65 A25: 34 - 37 A25: 38 - 41

Key on A25: 1

mm = Metric (mm)
in = Imperial (in)

Screws sold in multiples of 10



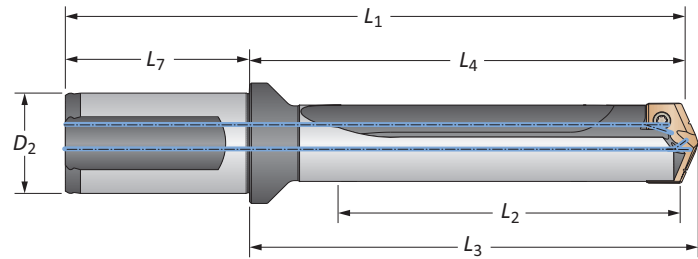

T-A Pro Drill Holders

2 Series Imperial | Diameter Range: 0.960" - 1.379"

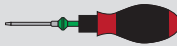

		Body				Shank			
Length	Sub Series	L ₂	L ₄	L ₃	L ₁	L ₇	D ₂	Flat	Part No
STUB	A	1.171	2.954	3.094	5.234	2.280	1-1/4	Yes	HTA2A01-125F
STUB	A	1.171	2.954	3.094	5.234	2.280	1-1/4	No	HTA2A01-125C
STUB	B	1.171	2.954	3.094	5.234	2.280	1-1/4	Yes	HTA2B01-125F
STUB	B	1.171	2.954	3.094	5.234	2.280	1-1/4	No	HTA2B01-125C
STUB	C	1.171	2.954	3.094	5.234	2.280	1-1/4	Yes	HTA2C01-125F
STUB	C	1.171	2.954	3.094	5.234	2.280	1-1/4	No	HTA2C01-125C
STUB	D	1.171	2.954	3.094	5.234	2.280	1-1/4	Yes	HTA2D01-125F
STUB	D	1.171	2.954	3.094	5.234	2.280	1-1/4	No	HTA2D01-125C
3xD	A	3.513	5.411	5.551	7.691	2.280	1-1/4	Yes	HTA2A03-125F
3xD	A	3.513	5.411	5.551	7.691	2.280	1-1/4	No	HTA2A03-125C
3xD	B	3.513	5.411	5.551	7.691	2.280	1-1/4	Yes	HTA2B03-125F
3xD	B	3.513	5.411	5.551	7.691	2.280	1-1/4	No	HTA2B03-125C
3xD	C	3.513	5.411	5.551	7.691	2.280	1-1/4	Yes	HTA2C03-125F
3xD	C	3.513	5.411	5.551	7.691	2.280	1-1/4	No	HTA2C03-125C
3xD	D	3.513	5.411	5.551	7.691	2.280	1-1/4	Yes	HTA2D03-125F
3xD	D	3.513	5.411	5.551	7.691	2.280	1-1/4	No	HTA2D03-125C
5xD	A	5.855	7.753	7.893	10.033	2.280	1-1/4	Yes	HTA2A05-125F
5xD	A	5.855	7.753	7.893	10.033	2.280	1-1/4	No	HTA2A05-125C
5xD	B	5.855	7.753	7.893	10.033	2.280	1-1/4	Yes	HTA2B05-125F
5xD	B	5.855	7.753	7.893	10.033	2.280	1-1/4	No	HTA2B05-125C
5xD	C	5.855	7.753	7.893	10.033	2.280	1-1/4	Yes	HTA2C05-125F
5xD	C	5.855	7.753	7.893	10.033	2.280	1-1/4	No	HTA2C05-125C
5xD	D	5.855	7.753	7.893	10.033	2.280	1-1/4	Yes	HTA2D05-125F
5xD	D	5.855	7.753	7.893	10.033	2.280	1-1/4	No	HTA2D05-125C
7xD	A	8.197	10.095	10.235	12.375	2.280	1-1/4	Yes	HTA2A07-125F
7xD	A	8.197	10.095	10.235	12.375	2.280	1-1/4	No	HTA2A07-125C
7xD	B	8.197	10.095	10.235	12.375	2.280	1-1/4	Yes	HTA2B07-125F
7xD	B	8.197	10.095	10.235	12.375	2.280	1-1/4	No	HTA2B07-125C
7xD	C	8.197	10.095	10.235	12.375	2.280	1-1/4	Yes	HTA2C07-125F
7xD	C	8.197	10.095	10.235	12.375	2.280	1-1/4	No	HTA2C07-125C
7xD	D	8.197	10.095	10.235	12.375	2.280	1-1/4	Yes	HTA2D07-125F
7xD	D	8.197	10.095	10.235	12.375	2.280	1-1/4	No	HTA2D07-125C

Connection Accessories

					Admissible Tightening Torque*
7495-IP15-1	7495N-IP15-1	8IP-15	8IP-15TL	8IP-15B	690 N-cm (61.0 in-lbs)

*Tightening torques are calculated with a friction coefficient of $\mu = 0.14$ and develop 90% of ultimate yield strength

1. WARNING Refer to Speed and Feed charts for recommended adjustments to speeds and feeds. Refer to page A25: 68 for deep hole drilling guidelines in this section of the catalog. Visit www.alliedmachine.com/DeepHoleGuidelines for the most up-to-date information and procedures. Factory technical assistance is available for your specific applications through our Application Engineering department.
email: engineering.eu@alliedmachine.com

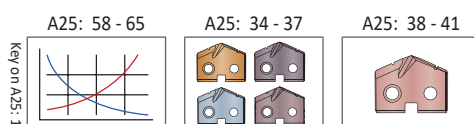

Key on A25: 1

 = Metric (mm)
 = Imperial (in)

Screws sold in multiples of 10

T-A Pro Drill Holders

2 Series Imperial | Diameter Range: 0.960" - 1.379"

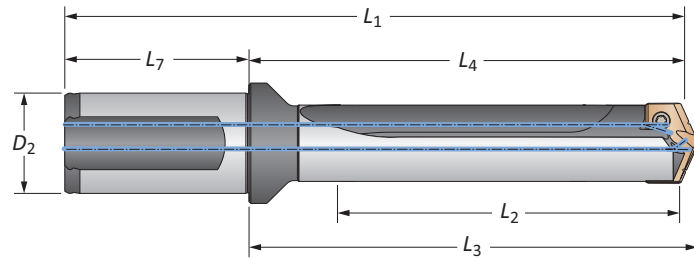

Length	Sub Series	Body				Shank			Flat	Part No
		L ₂	L ₄	L ₃	L ₁	L ₇	D ₂			
10xD	A	11.710	13.608	13.748	15.888	2.280	1-1/4	Yes	HTA2A10-125F	
10xD	A	11.710	13.608	13.748	15.888	2.280	1-1/4	No	HTA2A10-125C	
10xD	B	11.710	13.608	13.748	15.888	2.280	1-1/4	Yes	HTA2B10-125F	
10xD	B	11.710	13.608	13.748	15.888	2.280	1-1/4	No	HTA2B10-125C	
10xD	C	11.710	13.608	13.748	15.888	2.280	1-1/4	Yes	HTA2C10-125F	
10xD	C	11.710	13.608	13.748	15.888	2.280	1-1/4	No	HTA2C10-125C	
10xD	D	11.710	13.608	13.748	15.888	2.280	1-1/4	Yes	HTA2D10-125F	
10xD	D	11.710	13.608	13.748	15.888	2.280	1-1/4	No	HTA2D10-125C	
12xD	A	14.052	15.950	16.090	18.230	2.280	1-1/4	Yes	HTA2A12-125F	
12xD	A	14.052	15.950	16.090	18.230	2.280	1-1/4	No	HTA2A12-125C	
12xD	B	14.052	15.950	16.090	18.230	2.280	1-1/4	Yes	HTA2B12-125F	
12xD	B	14.052	15.950	16.090	18.230	2.280	1-1/4	No	HTA2B12-125C	
12xD	C	14.052	15.950	16.090	18.230	2.280	1-1/4	Yes	HTA2C12-125F	
12xD	C	14.052	15.950	16.090	18.230	2.280	1-1/4	No	HTA2C12-125C	
12xD	D	14.052	15.950	16.090	18.230	2.280	1-1/4	Yes	HTA2D12-125F	
12xD	D	14.052	15.950	16.090	18.230	2.280	1-1/4	No	HTA2D12-125C	
15xD	A	17.565	19.463	19.603	21.743	2.280	1-1/4	Yes	HTA2A15-125F	
15xD	A	17.565	19.463	19.603	21.743	2.280	1-1/4	No	HTA2A15-125C	
15xD	B	17.565	19.463	19.603	21.743	2.280	1-1/4	Yes	HTA2B15-125F	
15xD	B	17.565	19.463	19.603	21.743	2.280	1-1/4	No	HTA2B15-125C	
15xD	C	17.565	19.463	19.603	21.743	2.280	1-1/4	Yes	HTA2C15-125F	
15xD	C	17.565	19.463	19.603	21.743	2.280	1-1/4	No	HTA2C15-125C	
15xD	D	17.565	19.463	19.603	21.743	2.280	1-1/4	Yes	HTA2D15-125F	
15xD	D	17.565	19.463	19.603	21.743	2.280	1-1/4	No	HTA2D15-125C	

i

A

DRILLING

B

BORING

C

REAMING

D

BURNISHING

F

THREADING

X

SPECIALS

Connection Accessories

					Admissible Tightening Torque*
7495-IP15-1	7495N-IP15-1	8IP-15	8IP-15TL	8IP-15B	690 N-cm (61.0 in-lbs)

*Tightening torques are calculated with a friction coefficient of $\mu = 0.14$ and develop 90% of ultimate yield strength

WARNING Refer to Speed and Feed charts for recommended adjustments to speeds and feeds. Refer to page A25: 68 for deep hole drilling guidelines in this section of the catalog. Visit www.alliedmachine.com/DeepHoleGuidelines for the most up-to-date information and procedures. Factory technical assistance is available for your specific applications through our Application Engineering department. email: engineering.eu@alliedmachine.com

A25: 58 - 65 A25: 34 - 37 A25: 38 - 41

Key on A25: 1





= Metric (mm)
 = Imperial (in)

Screws sold in multiples of 10

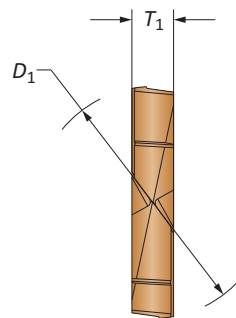
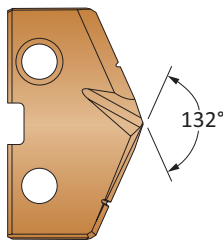
T-A Pro Carbide Drill Inserts

3 Series | Diameter Range: 35.05mm - 47.80mm (1.380" - 1.882")



Series	Insert			T ₁				
	D ₁ mm	D ₁ inch	Fractional Equivalent		Part No.	Part No.	Part No.	Part No.
					P	K	N	M
3-A	35.72	1.4063	1-13/32	1/4	TAP3-35.72	TAK3-35.72	TAN3-35.72	TAM3-35.72
3-A	35.80	1.4094		1/4	TAP3-35.80	TAK3-35.80	TAN3-35.80	TAM3-35.80
3-A	35.90	1.4134		1/4	TAP3-35.90	TAK3-35.90	TAN3-35.90	TAM3-35.90
3-A	36.00	1.4173		1/4	TAP3-36.00	TAK3-36.00	TAN3-36.00	TAM3-36.00
3-A	36.10	1.4213		1/4	TAP3-36.10	TAK3-36.10	TAN3-36.10	TAM3-36.10
3-A	36.20	1.4252		1/4	TAP3-36.20	TAK3-36.20	TAN3-36.20	TAM3-36.20
3-A	36.30	1.4291		1/4	TAP3-36.30	TAK3-36.30	TAN3-36.30	TAM3-36.30
3-A	36.40	1.4331		1/4	TAP3-36.40	TAK3-36.40	TAN3-36.40	TAM3-36.40
3-A	36.50	1.4370		1/4	TAP3-36.50	TAK3-36.50	TAN3-36.50	TAM3-36.50
3-A	36.51	1.4374	1-7/16	1/4	TAP3-36.51	TAK3-36.51	TAN3-36.51	TAM3-36.51
3-A	36.60	1.4409		1/4	TAP3-36.60	TAK3-36.60	TAN3-36.60	TAM3-36.60
3-A	36.70	1.4449		1/4	TAP3-36.70	TAK3-36.70	TAN3-36.70	TAM3-36.70
3-A	36.80	1.4488		1/4	TAP3-36.80	TAK3-36.80	TAN3-36.80	TAM3-36.80
3-A	36.90	1.4528		1/4	TAP3-36.90	TAK3-36.90	TAN3-36.90	TAM3-36.90
3-A	37.00	1.4567		1/4	TAP3-37.00	TAK3-37.00	TAN3-37.00	TAM3-37.00
3-A	37.10	1.4606		1/4	TAP3-37.10	TAK3-37.10	TAN3-37.10	TAM3-37.10
3-A	37.20	1.4646		1/4	TAP3-37.20	TAK3-37.20	TAN3-37.20	TAM3-37.20
3-A	37.30	1.4685		1/4	TAP3-37.30	TAK3-37.30	TAN3-37.30	TAM3-37.30
3-A	37.31	1.4689	1-15/32	1/4	TAP3-37.31	TAK3-37.31	TAN3-37.31	TAM3-37.31
3-A	37.40	1.4724		1/4	TAP3-37.40	TAK3-37.40	TAN3-37.40	TAM3-37.40
3-A	37.50	1.4764		1/4	TAP3-37.50	TAK3-37.50	TAN3-37.50	TAM3-37.50
3-A	37.60	1.4803		1/4	TAP3-37.60	TAK3-37.60	TAN3-37.60	TAM3-37.60
3-A	37.70	1.4843		1/4	TAP3-37.70	TAK3-37.70	TAN3-37.70	TAM3-37.70

Inserts sold in multiples of 1

Sub Series Holders (A, B, C, D)

Sub series holders are recommended when running carbide inserts toward the upper end of the series drill range, as well as in tougher applications requiring more insert support and holder strength. **NOTE:** Only specified sub series inserts should be used with equivalent or smaller sub series holders.



A Series Insert + A Series Holder



C Series Insert + A Series Holder



C Series Insert + C Series Holder



A Series Insert + C Series Holder

A25: 58 - 65

A25: 54 - 57

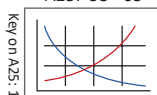

Sizes not shown are available upon request.





When ordering, please follow the example below:

Metric:	13.16mm, Steel, 0 series = use Part No. TAP0-13.16
Imperial:	0.5180", Steel, 0 series = use Part No. TAP0-13.16

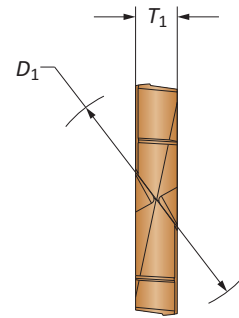
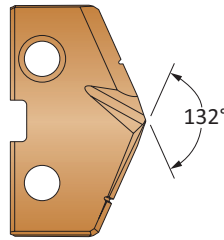
T-A Pro Carbide Drill Inserts

3 Series | Diameter Range: 35.05mm - 47.80mm (1.380" - 1.882")



Insert								
Series	D ₁ mm	D ₁ inch	Fractional Equivalent	T ₁	Part No. P	Part No. K	Part No. N	Part No. M
3-B	37.80	1.4882		1/4	TAP3-37.80	TAK3-37.80	TAN3-37.80	TAM3-37.80
3-B	37.90	1.4921		1/4	TAP3-37.90	TAK3-37.90	TAN3-37.90	TAM3-37.90
3-B	38.00	1.4961		1/4	TAP3-38.00	TAK3-38.00	TAN3-38.00	TAM3-38.00
3-B	38.10	1.5000	1-1/2	1/4	TAP3-38.10	TAK3-38.10	TAN3-38.10	TAM3-38.10
3-B	38.20	1.5039		1/4	TAP3-38.20	TAK3-38.20	TAN3-38.20	TAM3-38.20
3-B	38.30	1.5079		1/4	TAP3-38.30	TAK3-38.30	TAN3-38.30	TAM3-38.30
3-B	38.40	1.5118		1/4	TAP3-38.40	TAK3-38.40	TAN3-38.40	TAM3-38.40
3-B	38.50	1.5157		1/4	TAP3-38.50	TAK3-38.50	TAN3-38.50	TAM3-38.50
3-B	38.60	1.5197		1/4	TAP3-38.60	TAK3-38.60	TAN3-38.60	TAM3-38.60
3-B	38.70	1.5236		1/4	TAP3-38.70	TAK3-38.70	TAN3-38.70	TAM3-38.70
3-B	38.80	1.5276		1/4	TAP3-38.80	TAK3-38.80	TAN3-38.80	TAM3-38.80
3-B	38.89	1.5311	1-17/32	1/4	TAP3-38.89	TAK3-38.89	TAN3-38.89	TAM3-38.89
3-B	38.90	1.5315		1/4	TAP3-38.90	TAK3-38.90	TAN3-38.90	TAM3-38.90
3-B	39.00	1.5354		1/4	TAP3-39.00	TAK3-39.00	TAN3-39.00	TAM3-39.00
3-B	39.10	1.5394		1/4	TAP3-39.10	TAK3-39.10	TAN3-39.10	TAM3-39.10
3-B	39.20	1.5433		1/4	TAP3-39.20	TAK3-39.20	TAN3-39.20	TAM3-39.20
3-B	39.29	1.5469		1/4	TAP3-39.29	TAK3-39.29	TAN3-39.29	TAM3-39.29
3-B	39.30	1.5472		1/4	TAP3-39.30	TAK3-39.30	TAN3-39.30	TAM3-39.30
3-B	39.40	1.5512		1/4	TAP3-39.40	TAK3-39.40	TAN3-39.40	TAM3-39.40
3-B	39.50	1.5551		1/4	TAP3-39.50	TAK3-39.50	TAN3-39.50	TAM3-39.50
3-B	39.60	1.5591		1/4	TAP3-39.60	TAK3-39.60	TAN3-39.60	TAM3-39.60
3-B	39.69	1.5626	1-9/16	1/4	TAP3-39.69	TAK3-39.69	TAN3-39.69	TAM3-39.69
3-B	39.70	1.5630		1/4	TAP3-39.70	TAK3-39.70	TAN3-39.70	TAM3-39.70
3-B	39.80	1.5669		1/4	TAP3-39.80	TAK3-39.80	TAN3-39.80	TAM3-39.80
3-B	39.90	1.5709		1/4	TAP3-39.90	TAK3-39.90	TAN3-39.90	TAM3-39.90
3-B	40.00	1.5748		1/4	TAP3-40.00	TAK3-40.00	TAN3-40.00	TAM3-40.00
3-B	40.10	1.5787		1/4	TAP3-40.10	TAK3-40.10	TAN3-40.10	TAM3-40.10
3-B	40.20	1.5827		1/4	TAP3-40.20	TAK3-40.20	TAN3-40.20	TAM3-40.20
3-B	40.30	1.5866		1/4	TAP3-40.30	TAK3-40.30	TAN3-40.30	TAM3-40.30
3-B	40.40	1.5906		1/4	TAP3-40.40	TAK3-40.40	TAN3-40.40	TAM3-40.40
3-B	40.48	1.5937	1-19/32	1/4	TAP3-40.48	TAK3-40.48	TAN3-40.48	TAM3-40.48
3-B	40.50	1.5945		1/4	TAP3-40.50	TAK3-40.50	TAN3-40.50	TAM3-40.50
3-B	40.60	1.5984		1/4	TAP3-40.60	TAK3-40.60	TAN3-40.60	TAM3-40.60
3-B	40.70	1.6024		1/4	TAP3-40.70	TAK3-40.70	TAN3-40.70	TAM3-40.70
3-B	40.80	1.6063		1/4	TAP3-40.80	TAK3-40.80	TAN3-40.80	TAM3-40.80
3-B	40.90	1.6102		1/4	TAP3-40.90	TAK3-40.90	TAN3-40.90	TAM3-40.90

Inserts sold in multiples of 1

Sub Series Holders (A, B, C, D)

Sub series holders are recommended when running carbide inserts toward the upper end of the series drill range, as well as in tougher applications requiring more insert support and holder strength. **NOTE:** Only specified sub series inserts should be used with equivalent or smaller sub series holders.



A Series Insert +
A Series Holder



C Series Insert +
A Series Holder



C Series Insert +
C Series Holder



A Series Insert +
C Series Holder

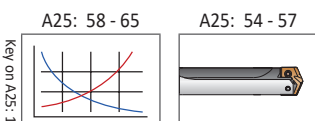

Sizes not shown are available upon request.
When ordering, please follow the example below:

Metric:	13.16mm, Steel, 0 series = use Part No. TAP0-13.16
Imperial:	0.5180", Steel, 0 series = use Part No. TAP0-13.16

A
DRILLING
B
BORING
C
REAMING
D
BURNISHING
E
THREADING
X
SPECIALS

T-A Pro Carbide Drill Inserts

3 Series | Diameter Range: 35.05mm - 47.80mm (1.380" - 1.882")

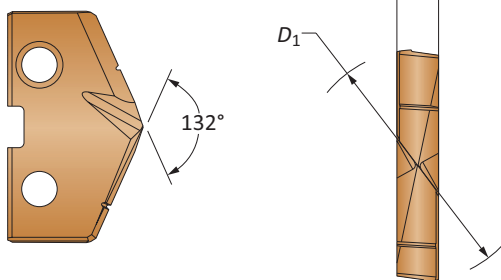

Insert								
Series	D ₁ mm	D ₁ inch	Fractional Equivalent	T ₁	Part No. P	Part No. K	Part No. N	Part No. M
3-C	41.00	1.6142		1/4	TAP3-41.00	TAK3-41.00	TAN3-41.00	TAM3-41.00
3-C	41.10	1.6181		1/4	TAP3-41.10	TAK3-41.10	TAN3-41.10	TAM3-41.10
3-C	41.20	1.6220		1/4	TAP3-41.20	TAK3-41.20	TAN3-41.20	TAM3-41.20
3-C	41.28	1.6252	1-5/8	1/4	TAP3-41.28	TAK3-41.28	TAN3-41.28	TAM3-41.28
3-C	41.30	1.6260		1/4	TAP3-41.30	TAK3-41.30	TAN3-41.30	TAM3-41.30
3-C	41.40	1.6299		1/4	TAP3-41.40	TAK3-41.40	TAN3-41.40	TAM3-41.40
3-C	41.50	1.6339		1/4	TAP3-41.50	TAK3-41.50	TAN3-41.50	TAM3-41.50
3-C	41.60	1.6378		1/4	TAP3-41.60	TAK3-41.60	TAN3-41.60	TAM3-41.60
3-C	41.70	1.6417		1/4	TAP3-41.70	TAK3-41.70	TAN3-41.70	TAM3-41.70
3-C	41.80	1.6457		1/4	TAP3-41.80	TAK3-41.80	TAN3-41.80	TAM3-41.80
3-C	41.90	1.6496		1/4	TAP3-41.90	TAK3-41.90	TAN3-41.90	TAM3-41.90
3-C	42.00	1.6535		1/4	TAP3-42.00	TAK3-42.00	TAN3-42.00	TAM3-42.00
3-C	42.07	1.6563	1-21/32	1/4	TAP3-42.07	TAK3-42.07	TAN3-42.07	TAM3-42.07
3-C	42.10	1.6575		1/4	TAP3-42.10	TAK3-42.10	TAN3-42.10	TAM3-42.10
3-C	42.20	1.6614		1/4	TAP3-42.20	TAK3-42.20	TAN3-42.20	TAM3-42.20
3-C	42.30	1.6654		1/4	TAP3-42.30	TAK3-42.30	TAN3-42.30	TAM3-42.30
3-C	42.40	1.6693		1/4	TAP3-42.40	TAK3-42.40	TAN3-42.40	TAM3-42.40
3-C	42.50	1.6732		1/4	TAP3-42.50	TAK3-42.50	TAN3-42.50	TAM3-42.50
3-C	42.60	1.6772		1/4	TAP3-42.60	TAK3-42.60	TAN3-42.60	TAM3-42.60
3-C	42.70	1.6811		1/4	TAP3-42.70	TAK3-42.70	TAN3-42.70	TAM3-42.70
3-C	42.80	1.6850		1/4	TAP3-42.80	TAK3-42.80	TAN3-42.80	TAM3-42.80
3-C	42.86	1.6874	1-11/16	1/4	TAP3-42.86	TAK3-42.86	TAN3-42.86	TAM3-42.86
3-C	42.90	1.6890		1/4	TAP3-42.90	TAK3-42.90	TAN3-42.90	TAM3-42.90
3-C	43.00	1.6929		1/4	TAP3-43.00	TAK3-43.00	TAN3-43.00	TAM3-43.00
3-C	43.10	1.6969		1/4	TAP3-43.10	TAK3-43.10	TAN3-43.10	TAM3-43.10
3-C	43.20	1.7008		1/4	TAP3-43.20	TAK3-43.20	TAN3-43.20	TAM3-43.20
3-C	43.30	1.7047		1/4	TAP3-43.30	TAK3-43.30	TAN3-43.30	TAM3-43.30
3-C	43.40	1.7087		1/4	TAP3-43.40	TAK3-43.40	TAN3-43.40	TAM3-43.40
3-C	43.50	1.7126		1/4	TAP3-43.50	TAK3-43.50	TAN3-43.50	TAM3-43.50
3-C	43.60	1.7165		1/4	TAP3-43.60	TAK3-43.60	TAN3-43.60	TAM3-43.60
3-C	43.66	1.7189	1-23/32	1/4	TAP3-43.66	TAK3-43.66	TAN3-43.66	TAM3-43.66
3-C	43.70	1.7205		1/4	TAP3-43.70	TAK3-43.70	TAN3-43.70	TAM3-43.70
3-C	43.80	1.7244		1/4	TAP3-43.80	TAK3-43.80	TAN3-43.80	TAM3-43.80
3-C	43.90	1.7283		1/4	TAP3-43.90	TAK3-43.90	TAN3-43.90	TAM3-43.90
3-C	44.00	1.7323		1/4	TAP3-44.00	TAK3-44.00	TAN3-44.00	TAM3-44.00
3-C	44.10	1.7362		1/4	TAP3-44.10	TAK3-44.10	TAN3-44.10	TAM3-44.10
3-C	44.20	1.7402		1/4	TAP3-44.20	TAK3-44.20	TAN3-44.20	TAM3-44.20
3-C	44.30	1.7441		1/4	TAP3-44.30	TAK3-44.30	TAN3-44.30	TAM3-44.30

Inserts sold in multiples of 1

Sub Series Holders (A, B, C, D)

Sub series holders are recommended when running carbide inserts toward the upper end of the series drill range, as well as in tougher applications requiring more insert support and holder strength. **NOTE:** Only specified sub series inserts should be used with equivalent or smaller sub series holders.



A Series Insert +
A Series Holder



C Series Insert +
A Series Holder



C Series Insert +
C Series Holder



A Series Insert +
C Series Holder

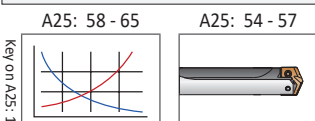



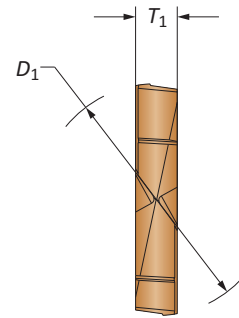
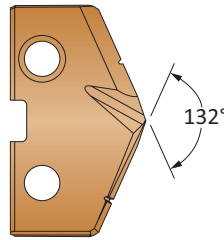

Sizes not shown are available upon request.	
When ordering, please follow the example below:	
Metric:	13.16mm, Steel, 0 series = use Part No. TAP0-13.16
Imperial:	0.5180", Steel, 0 series = use Part No. TAP0-13.16

T-A Pro Carbide Drill Inserts

3 Series | Diameter Range: 35.05mm - 47.80mm (1.380" - 1.882")



Insert								
Series	D ₁ mm	D ₁ inch	Fractional Equivalent	T ₁	P	K	N	M
3-D	44.40	1.7480		1/4	TAP3-44.40	TAK3-44.40	TAN3-44.40	TAM3-44.40
3-D	44.45	1.7500	1-3/4	1/4	TAP3-44.45	TAK3-44.45	TAN3-44.45	TAM3-44.45
3-D	44.50	1.7520		1/4	TAP3-44.50	TAK3-44.50	TAN3-44.50	TAM3-44.50
3-D	44.60	1.7559		1/4	TAP3-44.60	TAK3-44.60	TAN3-44.60	TAM3-44.60
3-D	44.70	1.7598		1/4	TAP3-44.70	TAK3-44.70	TAN3-44.70	TAM3-44.70
3-D	44.80	1.7638		1/4	TAP3-44.80	TAK3-44.80	TAN3-44.80	TAM3-44.80
3-D	44.90	1.7677		1/4	TAP3-44.90	TAK3-44.90	TAN3-44.90	TAM3-44.90
3-D	45.00	1.7717		1/4	TAP3-45.00	TAK3-45.00	TAN3-45.00	TAM3-45.00
3-D	45.10	1.7756		1/4	TAP3-45.10	TAK3-45.10	TAN3-45.10	TAM3-45.10
3-D	45.20	1.7795		1/4	TAP3-45.20	TAK3-45.20	TAN3-45.20	TAM3-45.20
3-D	45.24	1.7811	1-25/32	1/4	TAP3-45.24	TAK3-45.24	TAN3-45.24	TAM3-45.24
3-D	45.30	1.7835		1/4	TAP3-45.30	TAK3-45.30	TAN3-45.30	TAM3-45.30
3-D	45.40	1.7874		1/4	TAP3-45.40	TAK3-45.40	TAN3-45.40	TAM3-45.40
3-D	45.50	1.7913		1/4	TAP3-45.50	TAK3-45.50	TAN3-45.50	TAM3-45.50
3-D	45.50	1.7913		1/4	TAP3-45.50	TAK3-45.50	TAN3-45.50	TAM3-45.50
3-D	45.60	1.7953		1/4	TAP3-45.60	TAK3-45.60	TAN3-45.60	TAM3-45.60
3-D	45.64	1.7969		1/4	TAP3-45.64	TAK3-45.64	TAN3-45.64	TAM3-45.64
3-D	45.70	1.7992		1/4	TAP3-45.70	TAK3-45.70	TAN3-45.70	TAM3-45.70
3-D	45.80	1.8031		1/4	TAP3-45.80	TAK3-45.80	TAN3-45.80	TAM3-45.80
3-D	45.90	1.8071		1/4	TAP3-45.90	TAK3-45.90	TAN3-45.90	TAM3-45.90
3-D	46.00	1.8110		1/4	TAP3-46.00	TAK3-46.00	TAN3-46.00	TAM3-46.00
3-D	46.04	1.8126	1-13/16	1/4	TAP3-46.04	TAK3-46.04	TAN3-46.04	TAM3-46.04
3-D	46.10	1.8150		1/4	TAP3-46.10	TAK3-46.10	TAN3-46.10	TAM3-46.10
3-D	46.20	1.8189		1/4	TAP3-46.20	TAK3-46.20	TAN3-46.20	TAM3-46.20
3-D	46.30	1.8228		1/4	TAP3-46.30	TAK3-46.30	TAN3-46.30	TAM3-46.30
3-D	46.40	1.8268		1/4	TAP3-46.40	TAK3-46.40	TAN3-46.40	TAM3-46.40
3-D	46.50	1.8307		1/4	TAP3-46.50	TAK3-46.50	TAN3-46.50	TAM3-46.50
3-D	46.60	1.8346		1/4	TAP3-46.60	TAK3-46.60	TAN3-46.60	TAM3-46.60
3-D	46.70	1.8386		1/4	TAP3-46.70	TAK3-46.70	TAN3-46.70	TAM3-46.70
3-D	46.80	1.8425		1/4	TAP3-46.80	TAK3-46.80	TAN3-46.80	TAM3-46.80
3-D	46.83	1.8437	1-27/32	1/4	TAP3-46.83	TAK3-46.83	TAN3-46.83	TAM3-46.83
3-D	46.90	1.8465		1/4	TAP3-46.90	TAK3-46.90	TAN3-46.90	TAM3-46.90
3-D	47.00	1.8504		1/4	TAP3-47.00	TAK3-47.00	TAN3-47.00	TAM3-47.00
3-D	47.10	1.8543		1/4	TAP3-47.10	TAK3-47.10	TAN3-47.10	TAM3-47.10
3-D	47.20	1.8583		1/4	TAP3-47.20	TAK3-47.20	TAN3-47.20	TAM3-47.20
3-D	47.30	1.8622		1/4	TAP3-47.30	TAK3-47.30	TAN3-47.30	TAM3-47.30
3-D	47.40	1.8661		1/4	TAP3-47.40	TAK3-47.40	TAN3-47.40	TAM3-47.40
3-D	47.50	1.8661		1/4	TAP3-47.50	TAK3-47.50	TAN3-47.50	TAM3-47.50
3-D	47.60	1.8740		1/4	TAP3-47.60	TAK3-47.60	TAN3-47.60	TAM3-47.60
3-D	47.63	1.8752	1-7/8	1/4	TAP3-47.63	TAK3-47.63	TAN3-47.63	TAM3-47.63

Inserts sold in multiples of 1

Sub Series Holders (A, B, C, D)

Sub series holders are recommended when running carbide inserts toward the upper end of the series drill range, as well as in tougher applications requiring more insert support and holder strength. **NOTE:** Only specified sub series inserts should be used with equivalent or smaller sub series holders.



A Series Insert + A Series Holder



C Series Insert + A Series Holder



C Series Insert + C Series Holder



A Series Insert + C Series Holder

A25: 58 - 65

A25: 54 - 57

Key on A25: 1

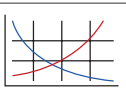

Sizes not shown are available upon request.

When ordering, please follow the example below:

Metric:	13.16mm, Steel, 0 series = use Part No. TAP0-13.16
Imperial:	0.5180", Steel, 0 series = use Part No. TAP0-13.16

A DRILLING
B BORING
C REAMING
D BURISHING
E THREADING
X SPECIALS

T-A Pro HSS Drill Inserts

3 Series | Diameter Range: 35.05mm - 47.80mm (1.380" - 1.882")

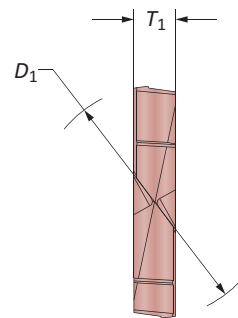
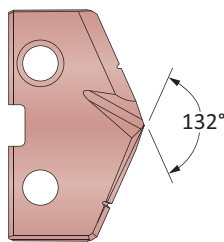

Series	D ₁ mm	D ₁ inch	Fractional Equivalent	T ₁	 Part No.
					X
3-A	35.72	1.4063	1-13/32	1/4	TAX3-35.72
3-A	35.80	1.4094		1/4	TAX3-35.80
3-A	35.90	1.4134		1/4	TAX3-35.90
3-A	36.00	1.4173		1/4	TAX3-36.00
3-A	36.10	1.4213		1/4	TAX3-36.10
3-A	36.20	1.4252		1/4	TAX3-36.20
3-A	36.30	1.4291		1/4	TAX3-36.30
3-A	36.40	1.4331		1/4	TAX3-36.40
3-A	36.50	1.4370		1/4	TAX3-36.50
3-A	36.51	1.4374	1-7/16	1/4	TAX3-36.51
3-A	36.60	1.4409		1/4	TAX3-36.60
3-A	36.70	1.4449		1/4	TAX3-36.70
3-A	36.80	1.4488		1/4	TAX3-36.80
3-A	36.90	1.4528		1/4	TAX3-36.90
3-A	37.00	1.4567		1/4	TAX3-37.00
3-A	37.10	1.4606		1/4	TAX3-37.10
3-A	37.20	1.4646		1/4	TAX3-37.20
3-A	37.30	1.4685		1/4	TAX3-37.30
3-A	37.31	1.4689	1-15/32	1/4	TAX3-37.31
3-A	37.40	1.4724		1/4	TAX3-37.40
3-A	37.50	1.4764		1/4	TAX3-37.50
3-A	37.60	1.4803		1/4	TAX3-37.60
3-A	37.70	1.4843		1/4	TAX3-37.70

Inserts sold in multiples of 1

Sub Series Holders (A, B, C, D)

Sub series holders are recommended when running carbide inserts toward the upper end of the series drill range, as well as in tougher applications requiring more insert support and holder strength. **NOTE:** Only specified sub series inserts should be used with equivalent or smaller sub series holders.



A Series Insert +
A Series Holder



C Series Insert +
A Series Holder



C Series Insert +
C Series Holder



A Series Insert +
C Series Holder

A25: 58 - 65

A25: 54 - 57

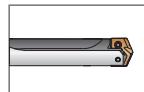
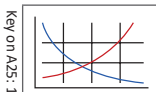

Sizes not shown are available upon request.

When ordering, please follow the example below:

Metric:	13.16mm, Steel, 0 series = use Part No. TAP0-13.16
Imperial:	0.5180", Steel, 0 series = use Part No. TAP0-13.16

T-A Pro HSS Drill Inserts

3 Series | Diameter Range: 35.05mm - 47.80mm (1.380" - 1.882")

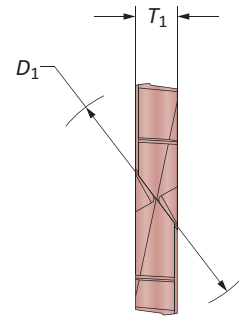
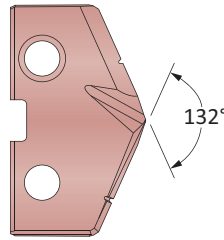

Series	D ₁ mm	D ₁ inch	Fractional Equivalent	T ₁	
					Part No.
3-B	37.80	1.4882		1/4	TAX3-37.80
3-B	37.90	1.4921		1/4	TAX3-37.90
3-B	38.00	1.4961		1/4	TAX3-38.00
3-B	38.10	1.5000	1-1/2	1/4	TAX3-38.10
3-B	38.20	1.5039		1/4	TAX3-38.20
3-B	38.30	1.5079		1/4	TAX3-38.30
3-B	38.40	1.5118		1/4	TAX3-38.40
3-B	38.50	1.5157		1/4	TAX3-38.50
3-B	38.60	1.5197		1/4	TAX3-38.60
3-B	38.70	1.5236		1/4	TAX3-38.70
3-B	38.80	1.5276		1/4	TAX3-38.80
3-B	38.89	1.5311	1-17/32	1/4	TAX3-38.89
3-B	38.90	1.5315		1/4	TAX3-38.90
3-B	39.00	1.5354		1/4	TAX3-39.00
3-B	39.10	1.5394		1/4	TAX3-39.10
3-B	39.20	1.5433		1/4	TAX3-39.20
3-B	39.29	1.5469		1/4	TAX3-39.29
3-B	39.30	1.5472		1/4	TAX3-39.30
3-B	39.40	1.5512		1/4	TAX3-39.40
3-B	39.50	1.5551		1/4	TAX3-39.50
3-B	39.60	1.5591		1/4	TAX3-39.60
3-B	39.69	1.5626	1-9/16	1/4	TAX3-39.69
3-B	39.70	1.5630		1/4	TAX3-39.70
3-B	39.80	1.5669		1/4	TAX3-39.80
3-B	39.90	1.5709		1/4	TAX3-39.90
3-B	40.00	1.5748		1/4	TAX3-40.00
3-B	40.10	1.5787		1/4	TAX3-40.10
3-B	40.20	1.5827		1/4	TAX3-40.20
3-B	40.30	1.5866		1/4	TAX3-40.30
3-B	40.40	1.5906		1/4	TAX3-40.40
3-B	40.48	1.5937	1-19/32	1/4	TAX3-40.48
3-B	40.50	1.5945		1/4	TAX3-40.50
3-B	40.60	1.5984		1/4	TAX3-40.60
3-B	40.70	1.6024		1/4	TAX3-40.70
3-B	40.80	1.6063		1/4	TAX3-40.80
3-B	40.90	1.6102		1/4	TAX3-40.90

Inserts sold in multiples of 1

Sub Series Holders (A, B, C, D)

Sub series holders are recommended when running carbide inserts toward the upper end of the series drill range, as well as in tougher applications requiring more insert support and holder strength. **NOTE:** Only specified sub series inserts should be used with equivalent or smaller sub series holders.



A Series Insert + A Series Holder



C Series Insert + A Series Holder



C Series Insert + C Series Holder



A Series Insert + C Series Holder

A25: 58 - 65

A25: 54 - 57

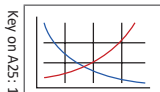

Sizes not shown are available upon request. When ordering, please follow the example below:

Metric:	13.16mm, Steel, 0 series = use Part No. TAP0-13.16
Imperial:	0.5180", Steel, 0 series = use Part No. TAP0-13.16

A
DRILLING
B
BORING
C
REAMING
D
BURNISHING
E
THREADING
X
SPECIALS

T-A Pro HSS Drill Inserts

3 Series | Diameter Range: 35.05mm - 47.80mm (1.380" - 1.882")

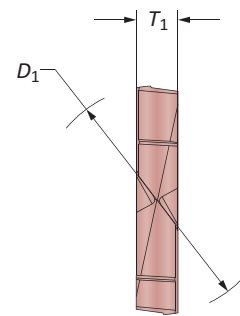
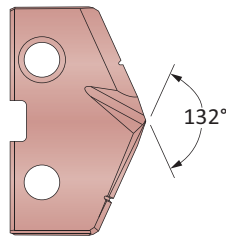
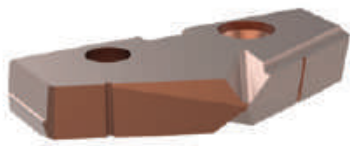

Insert					
Series	D_1 mm	D_1 inch	Fractional Equivalent	T_1	Part No.
3-C	41.00	1.6142		1/4	X
3-C	41.10	1.6181		1/4	TAX3-41.10
3-C	41.20	1.6220		1/4	TAX3-41.20
3-C	41.28	1.6252	1-5/8	1/4	TAX3-41.28
3-C	41.30	1.6260		1/4	TAX3-41.30
3-C	41.40	1.6299		1/4	TAX3-41.40
3-C	41.50	1.6339		1/4	TAX3-41.50
3-C	41.60	1.6378		1/4	TAX3-41.60
3-C	41.70	1.6417		1/4	TAX3-41.70
3-C	41.80	1.6457		1/4	TAX3-41.80
3-C	41.90	1.6496		1/4	TAX3-41.90
3-C	42.00	1.6535		1/4	TAX3-42.00
3-C	42.07	1.6563	1-21/32	1/4	TAX3-42.07
3-C	42.10	1.6575		1/4	TAX3-42.10
3-C	42.20	1.6614		1/4	TAX3-42.20
3-C	42.30	1.6654		1/4	TAX3-42.30
3-C	42.40	1.6693		1/4	TAX3-42.40
3-C	42.50	1.6732		1/4	TAX3-42.50
3-C	42.60	1.6772		1/4	TAX3-42.60
3-C	42.70	1.6811		1/4	TAX3-42.70
3-C	42.80	1.6850		1/4	TAX3-42.80
3-C	42.86	1.6874	1-11/16	1/4	TAX3-42.86
3-C	42.90	1.6890		1/4	TAX3-42.90
3-C	43.00	1.6929		1/4	TAX3-43.00
3-C	43.10	1.6969		1/4	TAX3-43.10
3-C	43.20	1.7008		1/4	TAX3-43.20
3-C	43.30	1.7047		1/4	TAX3-43.30
3-C	43.40	1.7087		1/4	TAX3-43.40
3-C	43.50	1.7126		1/4	TAX3-43.50
3-C	43.60	1.7165		1/4	TAX3-43.60
3-C	43.66	1.7189	1-23/32	1/4	TAX3-43.66
3-C	43.70	1.7205		1/4	TAX3-43.70
3-C	43.80	1.7244		1/4	TAX3-43.80
3-C	43.90	1.7283		1/4	TAX3-43.90
3-C	44.00	1.7323		1/4	TAX3-44.00
3-C	44.10	1.7362		1/4	TAX3-44.10
3-C	44.20	1.7402		1/4	TAX3-44.20
3-C	44.30	1.7441		1/4	TAX3-44.30

Inserts sold in multiples of 1

Sub Series Holders (A, B, C, D)

Sub series holders are recommended when running carbide inserts toward the upper end of the series drill range, as well as in tougher applications requiring more insert support and holder strength. **NOTE:** Only specified sub series inserts should be used with equivalent or smaller sub series holders.

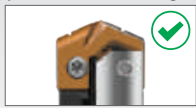

A Series Insert +
A Series Holder



C Series Insert +
A Series Holder



C Series Insert +
C Series Holder



A Series Insert +
C Series Holder

A25: 58 - 65

A25: 54 - 57

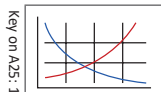

Key on A25: 1

Sizes not shown are available upon request.

When ordering, please follow the example below:

Metric:	13.16mm, Steel, 0 series = use Part No. TAP0-13.16
Imperial:	0.5180", Steel, 0 series = use Part No. TAP0-13.16

T-A Pro HSS Drill Inserts

3 Series | Diameter Range: 35.05mm - 47.80mm (1.380" - 1.882")

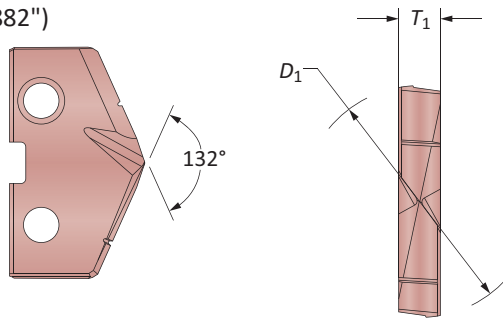

Series	Insert				Part No.
	D ₁ mm	D ₁ inch	Fractional Equivalent	T ₁	
3-D	44.40	1.7480		1/4	X
3-D	44.45	1.7500	1-3/4	1/4	TAX3-44.40
3-D	44.50	1.7520		1/4	TAX3-44.45
3-D	44.60	1.7559		1/4	TAX3-44.50
3-D	44.70	1.7598		1/4	TAX3-44.60
3-D	44.80	1.7638		1/4	TAX3-44.70
3-D	44.90	1.7677		1/4	TAX3-44.80
3-D	45.00	1.7717		1/4	TAX3-44.90
3-D	45.10	1.7756		1/4	TAX3-45.00
3-D	45.20	1.7795		1/4	TAX3-45.10
3-D	45.24	1.7811	1-25/32	1/4	TAX3-45.20
3-D	45.30	1.7835		1/4	TAX3-45.24
3-D	45.40	1.7874		1/4	TAX3-45.30
3-D	45.50	1.7913		1/4	TAX3-45.40
3-D	45.50	1.7913		1/4	TAX3-45.50
3-D	45.60	1.7953		1/4	TAX3-45.60
3-D	45.64	1.7969		1/4	TAX3-45.64
3-D	45.70	1.7992		1/4	TAX3-45.70
3-D	45.80	1.8031		1/4	TAX3-45.80
3-D	45.90	1.8071		1/4	TAX3-45.90
3-D	46.00	1.8110		1/4	TAX3-46.00
3-D	46.04	1.8126	1-13/16	1/4	TAX3-46.04
3-D	46.10	1.8150		1/4	TAX3-46.10
3-D	46.20	1.8189		1/4	TAX3-46.20
3-D	46.30	1.8228		1/4	TAX3-46.30
3-D	46.40	1.8268		1/4	TAX3-46.40
3-D	46.50	1.8307		1/4	TAX3-46.50
3-D	46.60	1.8346		1/4	TAX3-46.60
3-D	46.70	1.8386		1/4	TAX3-46.70
3-D	46.80	1.8425		1/4	TAX3-46.80
3-D	46.83	1.8437	1-27/32	1/4	TAX3-46.83
3-D	46.90	1.8465		1/4	TAX3-46.90
3-D	47.00	1.8504		1/4	TAX3-47.00
3-D	47.10	1.8543		1/4	TAX3-47.10
3-D	47.20	1.8583		1/4	TAX3-47.20
3-D	47.30	1.8622		1/4	TAX3-47.30
3-D	47.40	1.8661		1/4	TAX3-47.40
3-D	47.50	1.8661		1/4	TAX3-47.50
3-D	47.60	1.8740		1/4	TAX3-47.60
3-D	47.63	1.8752	1-7/8	1/4	TAX3-47.63

Inserts sold in multiples of 1

Sub Series Holders (A, B, C, D)

Sub series holders are recommended when running carbide inserts toward the upper end of the series drill range, as well as in tougher applications requiring more insert support and holder strength. **NOTE:** Only specified sub series inserts should be used with equivalent or smaller sub series holders.



A Series Insert + A Series Holder





C Series Insert + A Series Holder



C Series Insert + C Series Holder

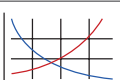

A Series Insert + C Series Holder

A25: 58 - 65  A25: 54 - 57 

Key on A25: 1

Sizes not shown are available upon request.
When ordering, please follow the example below:

Metric:	13.16mm, Steel, 0 series = use Part No. TAP0-13.16
Imperial:	0.5180", Steel, 0 series = use Part No. TAP0-13.16

A
DRILLING
B
BORING
C
REAMING
D
BURNISHING
E
THREADING
X
SPECIALS

3

 DRILLING | T-A Pro® High Penetration Replaceable Insert Drilling System

T-A Pro Drill Holders



3 Series Metric | Diameter Range: 35.05mm - 47.80mm

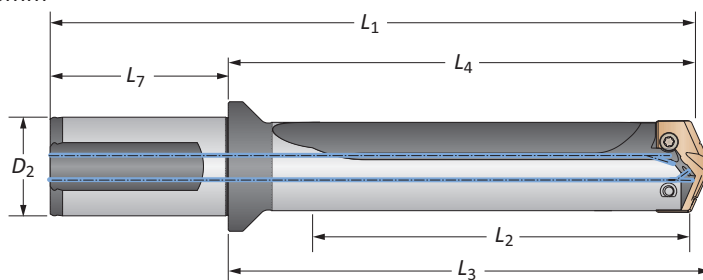





		Body				Shank				
Length	Sub Series	L ₂	L ₄	L ₃	L ₁	L ₇	D ₂	Flat	Part No	
STUB	A	41.1	92.3	97.1	160.6	68.3	40	Yes	HTA3A01-40FM	
STUB	A	41.1	92.3	97.1	160.6	68.3	40	No	HTA3A01-40CM	
STUB	B	41.1	92.3	97.1	160.6	68.3	40	Yes	HTA3B01-40FM	
STUB	B	41.1	92.3	97.1	160.6	68.3	40	No	HTA3B01-40CM	
STUB	C	41.1	92.3	97.1	160.6	68.3	40	Yes	HTA3C01-40FM	
STUB	C	41.1	92.3	97.1	160.6	68.3	40	No	HTA3C01-40CM	
STUB	D	41.1	92.3	97.1	160.6	68.3	40	Yes	HTA3D01-40FM	
STUB	D	41.1	92.3	97.1	160.6	68.3	40	No	HTA3D01-40CM	
3xD	A	123.3	180.1	184.8	248.3	68.3	40	Yes	HTA3A03-40FM	
3xD	A	123.3	180.1	184.8	248.3	68.3	40	No	HTA3A03-40CM	
3xD	B	123.3	180.1	184.8	248.3	68.3	40	Yes	HTA3B03-40FM	
3xD	B	123.3	180.1	184.8	248.3	68.3	40	No	HTA3B03-40CM	
3xD	C	123.3	180.1	184.8	248.3	68.3	40	Yes	HTA3C03-40FM	
3xD	C	123.3	180.1	184.8	248.3	68.3	40	No	HTA3C03-40CM	
3xD	D	123.3	180.1	184.8	248.3	68.3	40	Yes	HTA3D03-40FM	
3xD	D	123.3	180.1	184.8	248.3	68.3	40	No	HTA3D03-40CM	
5xD	A	205.5	262.2	267.0	330.5	68.3	40	Yes	HTA3A05-40FM	
5xD	A	205.5	262.2	267.0	330.5	68.3	40	No	HTA3A05-40CM	
5xD	B	205.5	262.2	267.0	330.5	68.3	40	Yes	HTA3B05-40FM	
5xD	B	205.5	262.2	267.0	330.5	68.3	40	No	HTA3B05-40CM	
5xD	C	205.5	262.2	267.0	330.5	68.3	40	Yes	HTA3C05-40FM	
5xD	C	205.5	262.2	267.0	330.5	68.3	40	No	HTA3C05-40CM	
5xD	D	205.5	262.2	267.0	330.5	68.3	40	Yes	HTA3D05-40FM	
5xD	D	205.5	262.2	267.0	330.5	68.3	40	No	HTA3D05-40CM	
7xD	A	287.7	344.4	349.2	412.7	68.3	40	Yes	HTA3A07-40FM	
7xD	A	287.7	344.4	349.2	412.7	68.3	40	No	HTA3A07-40CM	
7xD	B	287.7	344.4	349.2	412.7	68.3	40	Yes	HTA3B07-40FM	
7xD	B	287.7	344.4	349.2	412.7	68.3	40	No	HTA3B07-40CM	
7xD	C	287.7	344.4	349.2	412.7	68.3	40	Yes	HTA3C07-40FM	
7xD	C	287.7	344.4	349.2	412.7	68.3	40	No	HTA3C07-40CM	
7xD	D	287.7	344.4	349.2	412.7	68.3	40	Yes	HTA3D07-40FM	
7xD	D	287.7	344.4	349.2	412.7	68.3	40	No	HTA3D07-40CM	

Connection Accessories

 Insert Screws	 Nylon Locking Screws	 Insert Driver	Admissible Tightening Torque*
7514-IP20-1	7514N-IP20-1	8IP-20	121.3 in-lbs (1370 N-cm)

*Tightening torques are calculated with a friction coefficient of $\mu = 0.14$ and develop 90% of ultimate yield strength

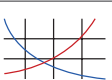
⚠ WARNING Refer to Speed and Feed charts for recommended adjustments to speeds and feeds. Refer to page A25: 68 for deep hole drilling guidelines in this section of the catalog. Visit www.alliedmachine.com/DeepHoleGuidelines for the most up-to-date information and procedures. Factory technical assistance is available for your specific applications through our Application Engineering department.
email: engineering.eu@alliedmachine.com

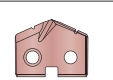
A25: 58 - 65  A25: 46 - 49  A25: 50 - 53 

Key on A25: 1

Ⓜ = Metric (mm)
Ⓢ = Imperial (in)

Screws sold in multiples of 10

A25: 54

www.alliedmachine.com | +44 (0) 1384 400 900 | enquiries.eu@alliedmachine.com

A DRILLING

B BORING

C REAMING

D BURNISHING

E THREADING

X SPECIALS

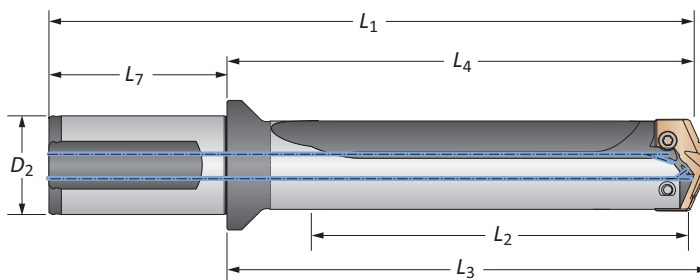

T-A Pro Drill Holders

3 Series Metric | Diameter Range: 35.05mm - 47.80mm



Length	Sub Series	Body				Shank				Flat	Part No
		L ₂	L ₄	L ₃	L ₁	L ₇	D ₂				
10xD	A	411.0	467.7	472.5	536.0	68.3	40	Yes	HTA3A10-40FM		
10xD	A	411.0	467.7	472.5	536.0	68.3	40	No	HTA3A10-40CM		
10xD	B	411.0	467.7	472.5	536.0	68.3	40	Yes	HTA3B10-40FM		
10xD	B	411.0	467.7	472.5	536.0	68.3	40	No	HTA3B10-40CM		
10xD	C	411.0	467.7	472.5	536.0	68.3	40	Yes	HTA3C10-40FM		
10xD	C	411.0	467.7	472.5	536.0	68.3	40	No	HTA3C10-40CM		
10xD	D	411.0	467.7	472.5	536.0	68.3	40	Yes	HTA3D10-40FM		
10xD	D	411.0	467.7	472.5	536.0	68.3	40	No	HTA3D10-40CM		
12xD	A	493.2	549.9	554.7	618.2	68.3	40	Yes	HTA3A12-40FM		
12xD	A	493.2	549.9	554.7	618.2	68.3	40	No	HTA3A12-40CM		
12xD	B	493.2	549.9	554.7	618.2	68.3	40	Yes	HTA3B12-40FM		
12xD	B	493.2	549.9	554.7	618.2	68.3	40	No	HTA3B12-40CM		
12xD	C	493.2	549.9	554.7	618.2	68.3	40	Yes	HTA3C12-40FM		
12xD	C	493.2	549.9	554.7	618.2	68.3	40	No	HTA3C12-40CM		
12xD	D	493.2	549.9	554.7	618.2	68.3	40	Yes	HTA3D12-40FM		
12xD	D	493.2	549.9	554.7	618.2	68.3	40	No	HTA3D12-40CM		
15xD	A	616.5	673.2	678.0	741.5	68.3	40	Yes	HTA3A15-40FM		
15xD	A	616.5	673.2	678.0	741.5	68.3	40	No	HTA3A15-40CM		
15xD	B	616.5	673.2	678.0	741.5	68.3	40	Yes	HTA3B15-40FM		
15xD	B	616.5	673.2	678.0	741.5	68.3	40	No	HTA3B15-40CM		
15xD	C	616.5	673.2	678.0	741.5	68.3	40	Yes	HTA3C15-40FM		
15xD	C	616.5	673.2	678.0	741.5	68.3	40	No	HTA3C15-40CM		
15xD	D	616.5	673.2	678.0	741.5	68.3	40	Yes	HTA3D15-40FM		
15xD	D	616.5	673.2	678.0	741.5	68.3	40	No	HTA3D15-40CM		

Connection Accessories

 Insert Screws	 Nylon Locking Screws	 Insert Driver	Admissible Tightening Torque*
7514-IP20-1	7514N-IP20-1	8IP-20	121.3 in-lbs (1370 N-cm)

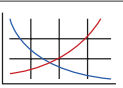

*Tightening torques are calculated with a friction coefficient of $\mu = 0.14$ and develop 90% of ultimate yield strength

WARNING Refer to Speed and Feed charts for recommended adjustments to speeds and feeds. Refer to page A25: 68 for deep hole drilling guidelines in this section of the catalog. Visit www.alliedmachine.com/DeepHoleGuidelines for the most up-to-date information and procedures. Factory technical assistance is available for your specific applications through our Application Engineering department.
email: engineering.eu@alliedmachine.com

A25: 58 - 65  Key on A25: 1

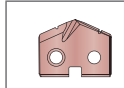
A25: 46 - 49 

A25: 50 - 53 

 = Metric (mm)
 = Imperial (in)
 Screws sold in multiples of 10

A
DRILLING
B
BORING
C
REAMING
D
BURNISHING
E
THREADING
X
SPECIALS

T-A Pro Drill Holders

3 Series Imperial | Diameter Range: 1.380" - 1.882"

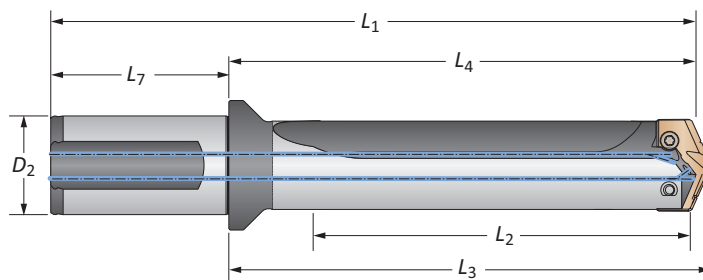

Body						Shank			Flat	Part No
Length	Sub Series	L ₂	L ₄	L ₃	L ₁	L ₇	D ₂			
STUB	A	1.618	3.634	3.821	6.322	2.688	1-1/2	Yes	HTA3A01-150F	
STUB	A	1.618	3.634	3.821	6.322	2.688	1-1/2	No	HTA3A01-150C	
STUB	B	1.618	3.634	3.821	6.322	2.688	1-1/2	Yes	HTA3B01-150F	
STUB	B	1.618	3.634	3.821	6.322	2.688	1-1/2	No	HTA3B01-150C	
STUB	C	1.618	3.634	3.821	6.322	2.688	1-1/2	Yes	HTA3C01-150F	
STUB	C	1.618	3.634	3.821	6.322	2.688	1-1/2	No	HTA3C01-150C	
STUB	D	1.618	3.634	3.821	6.322	2.688	1-1/2	Yes	HTA3D01-150F	
STUB	D	1.618	3.634	3.821	6.322	2.688	1-1/2	No	HTA3D01-150C	
3xD	A	4.854	7.089	7.276	9.777	2.688	1-1/2	Yes	HTA3A03-150F	
3xD	A	4.854	7.089	7.276	9.777	2.688	1-1/2	No	HTA3A03-150C	
3xD	B	4.854	7.089	7.276	9.777	2.688	1-1/2	Yes	HTA3B03-150F	
3xD	B	4.854	7.089	7.276	9.777	2.688	1-1/2	No	HTA3B03-150C	
3xD	C	4.854	7.089	7.276	9.777	2.688	1-1/2	Yes	HTA3C03-150F	
3xD	C	4.854	7.089	7.276	9.777	2.688	1-1/2	No	HTA3C03-150C	
3xD	D	4.854	7.089	7.276	9.777	2.688	1-1/2	Yes	HTA3D03-150F	
3xD	D	4.854	7.089	7.276	9.777	2.688	1-1/2	No	HTA3D03-150C	
5xD	A	8.090	10.325	10.512	13.013	2.688	1-1/2	Yes	HTA3A05-150F	
5xD	A	8.090	10.325	10.512	13.013	2.688	1-1/2	No	HTA3A05-150C	
5xD	B	8.090	10.325	10.512	13.013	2.688	1-1/2	Yes	HTA3B05-150F	
5xD	B	8.090	10.325	10.512	13.013	2.688	1-1/2	No	HTA3B05-150C	
5xD	C	8.090	10.325	10.512	13.013	2.688	1-1/2	Yes	HTA3C05-150F	
5xD	C	8.090	10.325	10.512	13.013	2.688	1-1/2	No	HTA3C05-150C	
5xD	D	8.090	10.325	10.512	13.013	2.688	1-1/2	Yes	HTA3D05-150F	
5xD	D	8.090	10.325	10.512	13.013	2.688	1-1/2	No	HTA3D05-150C	
7xD	A	11.326	13.561	13.748	16.249	2.688	1-1/2	Yes	HTA3A07-150F	
7xD	A	11.326	13.561	13.748	16.249	2.688	1-1/2	No	HTA3A07-150C	
7xD	B	11.326	13.561	13.748	16.249	2.688	1-1/2	Yes	HTA3B07-150F	
7xD	B	11.326	13.561	13.748	16.249	2.688	1-1/2	No	HTA3B07-150C	
7xD	C	11.326	13.561	13.748	16.249	2.688	1-1/2	Yes	HTA3C07-150F	
7xD	C	11.326	13.561	13.748	16.249	2.688	1-1/2	No	HTA3C07-150C	
7xD	D	11.326	13.561	13.748	16.249	2.688	1-1/2	Yes	HTA3D07-150F	
7xD	D	11.326	13.561	13.748	16.249	2.688	1-1/2	No	HTA3D07-150C	

Connection Accessories

Insert Screws	Nylon Locking Screws	Insert Driver	Admissible Tightening Torque*
7514-IP20-1	7514N-IP20-1	8IP-20	121.3 in-lbs (1370 N-cm)

*Tightening torques are calculated with a friction coefficient of $\mu = 0.14$ and develop 90% of ultimate yield strength

WARNING Refer to Speed and Feed charts for recommended adjustments to speeds and feeds. Refer to page A25: 68 for deep hole drilling guidelines in this section of the catalog. Visit www.alliedmachine.com/DeepHoleGuidelines for the most up-to-date information and procedures. Factory technical assistance is available for your specific applications through our Application Engineering department.
email: engineering.eu@alliedmachine.com

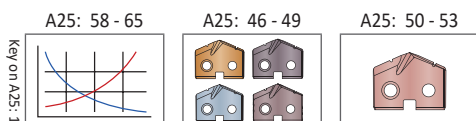

 = Metric (mm)
 = Imperial (in)

Screws sold in multiples of 10

T-A Pro Drill Holders

3 Series Imperial | Diameter Range: 1.380" - 1.882"

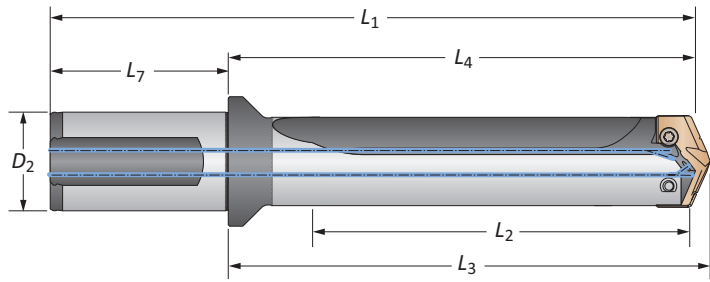

Length	Sub Series	Body				Shank			Flat	Part No
		L ₂	L ₄	L ₃	L ₁	L ₇	D ₂			
10xD	A	16.180	18.415	18.602	21.103	2.688	1-1/2	Yes	HTA3A10-150F	
10xD	A	16.180	18.415	18.602	21.103	2.688	1-1/2	No	HTA3A10-150C	
10xD	B	16.180	18.415	18.602	21.103	2.688	1-1/2	Yes	HTA3B10-150F	
10xD	B	16.180	18.415	18.602	21.103	2.688	1-1/2	No	HTA3B10-150C	
10xD	C	16.180	18.415	18.602	21.103	2.688	1-1/2	Yes	HTA3C10-150F	
10xD	C	16.180	18.415	18.602	21.103	2.688	1-1/2	No	HTA3C10-150C	
10xD	D	16.180	18.415	18.602	21.103	2.688	1-1/2	Yes	HTA3D10-150F	
10xD	D	16.180	18.415	18.602	21.103	2.688	1-1/2	No	HTA3D10-150C	
12xD	A	19.416	21.651	21.838	24.339	2.688	1-1/2	Yes	HTA3A12-150F	
12xD	A	19.416	21.651	21.838	24.339	2.688	1-1/2	No	HTA3A12-150C	
12xD	B	19.416	21.651	21.838	24.339	2.688	1-1/2	Yes	HTA3B12-150F	
12xD	B	19.416	21.651	21.838	24.339	2.688	1-1/2	No	HTA3B12-150C	
12xD	C	19.416	21.651	21.838	24.339	2.688	1-1/2	Yes	HTA3C12-150F	
12xD	C	19.416	21.651	21.838	24.339	2.688	1-1/2	No	HTA3C12-150C	
12xD	D	19.416	21.651	21.838	24.339	2.688	1-1/2	Yes	HTA3D12-150F	
12xD	D	19.416	21.651	21.838	24.339	2.688	1-1/2	No	HTA3D12-150C	
15xD	A	24.270	26.505	26.692	29.193	2.688	1-1/2	Yes	HTA3A15-150F	
15xD	A	24.270	26.505	26.692	29.193	2.688	1-1/2	No	HTA3A15-150C	
15xD	B	24.270	26.505	26.692	29.193	2.688	1-1/2	Yes	HTA3B15-150F	
15xD	B	24.270	26.505	26.692	29.193	2.688	1-1/2	No	HTA3B15-150C	
15xD	C	24.270	26.505	26.692	29.193	2.688	1-1/2	Yes	HTA3C15-150F	
15xD	C	24.270	26.505	26.692	29.193	2.688	1-1/2	No	HTA3C15-150C	
15xD	D	24.270	26.505	26.692	29.193	2.688	1-1/2	Yes	HTA3D15-150F	
15xD	D	24.270	26.505	26.692	29.193	2.688	1-1/2	No	HTA3D15-150C	

Connection Accessories

			Admissible Tightening Torque*
Insert Screws	Nylon Locking Screws	Insert Driver	
7514-IP20-1	7514N-IP20-1	8IP-20	121.3 in-lbs (1370 N-cm)

*Tightening torques are calculated with a friction coefficient of $\mu = 0.14$ and develop 90% of ultimate yield strength

⚠ WARNING Refer to Speed and Feed charts for recommended adjustments to speeds and feeds. Refer to page A25: 68 for deep hole drilling guidelines in this section of the catalog. Visit www.alliedmachine.com/DeepHoleGuidelines for the most up-to-date information and procedures. Factory technical assistance is available for your specific applications through our Application Engineering department.
email: engineering.eu@alliedmachine.com

A25: 58 - 65 A25: 46 - 49 A25: 50 - 53

Key on A25: 1

= Metric (mm)
 = Imperial (in)
Screws sold in multiples of 10

A DRILLING
B BORING
C REAMING
D BURNISHING
E THREADING
X SPECIALS



Carbide Recommended Drilling Data | Metric (mm)

Material	Hardness (BHN)	Insert Grade	Speed (M/min)	Feed Rate (mm/rev) by Diameter					
				9.50mm - 12.69mm	12.70mm - 17.64mm	17.65mm - 24.37mm	24.38mm - 35.04mm	35.05mm - 47.80mm	
P Free-Machining Steel 1118, 1215, 12L14, etc.	100 - 150	P	145	0.18	0.25	0.33	0.410	0.51	
	150 - 200	P	135	0.18	0.25	0.33	0.41	0.51	
	200 - 250	P	125	0.15	0.25	0.33	0.41	0.51	
	Low-Carbon Steel 1010, 1020, 1025, 1522, 1144, etc.	85 - 125	P	130	0.15	0.23	0.30	0.38	0.48
		125 - 175	P	125	0.15	0.23	0.30	0.38	0.48
		175 - 225	P	115	0.13	0.20	0.25	0.36	0.46
		225 - 275	P	110	0.13	0.20	0.25	0.36	0.46
	Medium-Carbon Steel 1030, 1040, 1050, 1527, 1140, 1151, etc.	125 - 175	P	125	0.15	0.23	0.30	0.38	0.48
		175 - 225	P	115	0.13	0.20	0.25	0.36	0.46
		225 - 275	P	110	0.13	0.20	0.25	0.36	0.46
		275 - 325	P	100	0.10	0.18	0.23	0.30	0.41
	Alloy Steel 4140, 5140, 8640, etc.	125 - 175	P	130	0.15	0.23	0.30	0.36	0.43
175 - 225		P	120	0.13	0.20	0.28	0.36	0.43	
225 - 275		P	110	0.13	0.20	0.28	0.36	0.43	
275 - 325		P	105	0.10	0.18	0.25	0.30	0.38	
325 - 375		P	95	0.08	0.18	0.25	0.30	0.38	
High-Strength Alloy 4340, 4330V, 300M, etc.	225 - 300	P	105	0.10	0.18	0.25	0.33	0.38	
	300 - 350	P	100	0.08	0.15	0.23	0.30	0.36	
	350 - 400	P	90	0.08	0.15	0.20	0.28	0.33	
Structural Steel A36, A285, A516, etc.	100 - 150	P	120	0.15	0.25	0.30	0.36	0.46	
	150 - 250	P	105	0.13	0.23	0.25	0.30	0.41	
	250 - 350	P	85	0.10	0.20	0.23	0.25	0.36	
Tool Steel H-13, H-21, A-4, S-3, etc.	150 - 200	P	65	0.10	0.15	0.20	0.25	0.30	
	200 - 250	P	55	0.10	0.15	0.20	0.25	0.30	
S High-Temp Alloy Hastelloy B, Inconel 600, etc.	140 - 220	M	33	0.05	0.13	0.18	0.20	0.23	
	220 - 310	M	26	0.05	0.08	0.13	0.15	0.18	
	Titanium Alloy	140 - 220	M	45	0.08	0.10	0.18	0.20	0.23
		220 - 310	M	36	0.08	0.08	0.13	0.15	0.18
	Aerospace Alloy S82	185 - 275	M	45	0.08	0.10	0.18	0.20	0.23
		275 - 350	M	36	0.08	0.08	0.13	0.15	0.18

7xD and 10xD Adjustment Example (0.80 Adjustment)

Data • Adjustment Value	Speed/Feed (7xD)
100 M/min • 0.80	= 80 M/min
0.2 mm/rev • 0.80	= 0.16 mm/rev

12xD and 15xD Adjustment Example (0.70 Adjustment)

Speed • Adjustment Value	Speed/Feed (12xD)
100 M/min • 0.70	= 70 M/min
0.2 mm/rev • 0.70	= 0.14 mm/rev

Coolant Recommendations

Series	STUB, 3xD, 5xD		7xD, 10xD		12xD, 15xD	
	Pressure BAR	Flow Rate LPM	Pressure BAR	Flow Rate LPM	Pressure BAR	Flow Rate LPM
Z	31	15	34	22	45	30
0	24	22	31	34	34	45
1	21	30	27	38	34	45
2	17	38	24	49	31	60
3	14	45	21	53	27	68

⚠ WARNING

Tool failure can cause serious injury. To prevent:

- When using holders without support bushing, use a short T-A Pro holder to establish an initial hole that is a minimum of 2 diameters deep.
- Do not rotate tool holders more than 50 RPM unless it is engaged with the workpiece or fixture.

Visit www.alliedmachine.com/DeepHoleGuidelines for the most up-to-date information and procedures.

Factory technical assistance is available for your specific applications through our Application Engineering department. email: engineering.eu@alliedmachine.com

IMPORTANT: The speeds and feeds listed above are a general starting point for all applications. Refer to the coolant recommendation chart for coolant requirements to run at the recommended speeds and feeds. Factory technical assistance is available through our Application Engineering department. For 7xD, 10xD, 12xD, and 15xD holder lengths, see adjustment example above.

Carbide Recommended Drilling Data | Metric (mm)

Material	Hardness (BHN)	Insert Grade	Speed (M/min)	Feed Rate (mm/rev) by Diameter					
				9.50mm - 12.69mm	12.70mm - 17.64mm	17.65mm - 24.37mm	24.38mm - 35.04mm	35.05mm - 47.80mm	
M Stainless Steel 400 Series 416, 420, etc.	185 - 275	M	85	0.13	0.25	0.28	0.30	0.33	
	275 - 350	M	75	0.10	0.23	0.25	0.28	0.30	
	Stainless Steel 300 Series 304, 316, 17-4PH, etc.	135 - 185	M	85	0.08	0.10	0.13	0.20	0.28
		185 - 275	M	75	0.05	0.08	0.10	0.18	0.23
	Stainless Steel 300L Series 304L, 316L etc.	135 - 185	M	100	0.08	0.10	0.13	0.20	0.28
		185 - 275	M	85	0.05	0.08	0.10	0.18	0.23
PH Stainless 17-4, 13-8, 15-5	275-350	M	85	0.08	0.10	0.13	0.20	0.28	
	350-425	M	75	0.05	0.08	0.10	0.18	0.23	
Super Duplex Stainless Steel	135 - 185	M	75	0.08	0.10	0.13	0.20	0.28	
	185 - 275	M	70	0.05	0.08	0.10	0.18	0.23	
H Wear Plate Hardox, AR400, T-1, etc.	400	P	20	0.08	0.15	0.20	0.23	0.30	
	500	P	15	0.05	0.13	0.18	0.20	0.25	
	600	N/A	-	-	-	-	-	-	
	Hardened Steel	300 - 400	P	30	0.08	0.15	0.20	0.23	0.30
400 - 500		P	15	0.05	0.13	0.18	0.20	0.25	
K SG / Nodular Cast Iron	120 - 150	K	185	0.18	0.30	0.41	0.51	0.61	
	150 - 200	K	170	0.15	0.28	0.36	0.46	0.56	
	200 - 220	K	150	0.15	0.23	0.30	0.41	0.46	
	220 - 260	K	135	0.13	0.18	0.23	0.30	0.36	
	260 - 320	K	120	0.10	0.15	0.18	0.23	0.30	
N Cast Aluminum	30	N	335	0.20	0.33	0.41	0.51	0.56	
	180	N	185	0.20	0.33	0.41	0.46	0.56	
	Wrought Aluminum	30	N	335	0.23	0.33	0.43	0.51	0.61
		180	N	185	0.13	0.18	0.25	0.33	0.41
	Aluminum Bronze	100 - 200	N	150	0.15	0.28	0.36	0.46	0.56
		200 - 250	N	90	0.13	0.18	0.23	0.30	0.36
	Brass	100	N	200	0.18	0.30	0.41	0.51	0.61
Copper	60	N	50	0.05	0.08	0.15	0.20	0.25	

7xD and 10xD Adjustment Example (0.80 Adjustment)

Data • Adjustment Value	Speed/Feed (7xD)
100 M/min • 0.80	= 80 M/min
0.2 mm/rev • 0.80	= 0.16 mm/rev

12xD and 15xD Adjustment Example (0.70 Adjustment)

Speed • Adjustment Value	Speed/Feed (12xD)
100 M/min • 0.70	= 70 M/min
0.2 mm/rev • 0.70	= 0.14 mm/rev

Coolant Recommendations

Series	STUB, 3xD, 5xD		7xD, 10xD		12xD, 15xD	
	Pressure BAR	Flow Rate LPM	Pressure BAR	Flow Rate LPM	Pressure BAR	Flow Rate LPM
Z	31	15	34	22	45	30
0	24	22	31	34	34	45
1	21	30	27	38	34	45
2	17	38	24	49	31	60
3	14	45	21	53	27	68

⚠ WARNING Tool failure can cause serious injury. To prevent:
 - When using holders without support bushing, use a short T-A Pro holder to establish an initial hole that is a minimum of 2 diameters deep.
 - Do not rotate tool holders more than 50 RPM unless it is engaged with the workpiece or fixture.
 Visit www.alliedmachine.com/DeepHoleGuidelines for the most up-to-date information and procedures.
 Factory technical assistance is available for your specific applications through our Application Engineering department. email: engineering.eu@alliedmachine.com

IMPORTANT: The speeds and feeds listed above are a general starting point for all applications. Refer to the coolant recommendation chart for coolant requirements to run at the recommended speeds and feeds. Factory technical assistance is available through our Application Engineering department. For 7xD, 10xD, 12xD, and 15xD holder lengths, see adjustment example above.

A
DRILLING
B
BORING
C
REAMING
D
BURNISHING
E
THREADING
X
SPECIALS



High-Speed Steel Recommended Drilling Data | Metric (mm)

Material	Hardness (BHN)	Insert Grade	Speed (M/min)	Feed Rate (mm/rev) by Diameter					
				9.50mm - 12.69mm	12.70mm - 17.64mm	17.65mm - 24.37mm	24.38mm - 35.04mm	35.05mm - 47.80mm	
Free-Machining Steel 1118, 1215, 12L14, etc.	100 - 150	X	105	0.18	0.25	0.33	0.41	0.51	
	150 - 200	X	100	0.18	0.25	0.33	0.41	0.51	
	200 - 250	X	90	0.15	0.25	0.33	0.41	0.51	
Low-Carbon Steel 1010, 1020, 1025, 1522, 1144, etc.	85 - 125	X	95	0.15	0.23	0.30	0.38	0.48	
	125 - 175	X	90	0.15	0.23	0.30	0.38	0.48	
	175 - 225	X	85	0.13	0.20	0.25	0.36	0.46	
	225 - 275	X	80	0.13	0.20	0.25	0.36	0.46	
Medium-Carbon Steel 1030, 1040, 1050, 1527, 1140, 1151, etc.	125 - 175	X	90	0.15	0.23	0.30	0.38	0.48	
	175 - 225	X	85	0.13	0.20	0.25	0.36	0.46	
	225 - 275	X	80	0.13	0.20	0.25	0.36	0.46	
	275 - 325	X	70	0.10	0.18	0.23	0.30	0.41	
Alloy Steel 4140, 5140, 8640, etc.	125 - 175	X	75	0.15	0.23	0.30	0.36	0.43	
	175 - 225	X	70	0.13	0.20	0.28	0.36	0.43	
	225 - 275	X	65	0.13	0.20	0.28	0.36	0.43	
	275 - 325	X	60	0.10	0.18	0.25	0.30	0.38	
	325 - 375	X	60	0.08	0.18	0.25	0.30	0.38	
High-Strength Alloy 4340, 4330V, 300M, etc.	225 - 300	X	40	0.10	0.18	0.25	0.33	0.38	
	300 - 350	X	35	0.08	0.15	0.23	0.30	0.36	
	350 - 400	X	25	0.08	0.15	0.20	0.28	0.33	
Structural Steel A36, A285, A516, etc.	100 - 150	X	75	0.15	0.25	0.30	0.36	0.46	
	150 - 250	X	65	0.13	0.23	0.25	0.30	0.41	
	250 - 350	X	55	0.10	0.20	0.23	0.25	0.36	
Tool Steel H-13, H-21, A-4, S-3, etc.	150 - 200	X	45	0.10	0.15	0.20	0.25	0.30	
	200 - 250	X	35	0.10	0.15	0.20	0.25	0.30	
High-Temp Alloy Hastelloy B, Inconel 600, etc.	140 - 220	X	15	0.08	0.18	0.20	0.25	0.30	
	220 - 310	X	10	0.08	0.15	0.18	0.20	0.25	
	Titanium Alloy	140 - 220	X	20	0.08	0.18	0.20	0.25	0.30
		220 - 310	X	15	0.08	0.15	0.18	0.20	0.25
	Aerospace Alloy S82	185 - 275	X	40	0.13	0.20	0.23	0.25	0.36
275 - 350		X	35	0.10	0.18	0.20	0.20	0.30	

7xD and 10xD Adjustment Example (0.80 Adjustment)

Data • Adjustment Value	Speed/Feed (7xD)
100 M/min • 0.80	= 80 M/min
0.2 mm/rev • 0.80	= 0.16 mm/rev

12xD and 15xD Adjustment Example (0.70 Adjustment)

Speed • Adjustment Value	Speed/Feed (12xD)
100 M/min • 0.70	= 70 M/min
0.2 mm/rev • 0.70	= 0.14 mm/rev

Coolant Recommendations

Series	STUB, 3xD, 5xD		7xD, 10xD		12xD, 15xD	
	Pressure BAR	Flow Rate LPM	Pressure BAR	Flow Rate LPM	Pressure BAR	Flow Rate LPM
Z	31	15	34	22	45	30
0	24	22	31	34	34	45
1	21	30	27	38	34	45
2	17	38	24	49	31	60
3	14	45	21	53	27	68

⚠ WARNING

Tool failure can cause serious injury. To prevent:

- When using holders without support bushing, use a short T-A Pro holder to establish an initial hole that is a minimum of 2 diameters deep.
- Do not rotate tool holders more than 50 RPM unless it is engaged with the workpiece or fixture.

Visit www.alliedmachine.com/DeepHoleGuidelines for the most up-to-date information and procedures.

Factory technical assistance is available for your specific applications through our Application Engineering department. email: engineering.eu@alliedmachine.com

IMPORTANT: The speeds and feeds listed above are a general starting point for all applications. Refer to the coolant recommendation chart for coolant requirements to run at the recommended speeds and feeds. Factory technical assistance is available through our Application Engineering department. For 7xD, 10xD, 12xD, and 15xD holder lengths, see adjustment example above.

High-Speed Steel Recommended Drilling Data | Metric (mm)

Material	Hardness (BHN)	Insert Grade	Speed (M/min)	Feed Rate (mm/rev) by Diameter					
				9.50mm - 12.69mm	12.70mm - 17.64mm	17.65mm - 24.37mm	24.38mm - 35.04mm	35.05mm - 47.80mm	
M Stainless Steel 400 Series 416, 420, etc.	185 - 275	X	40	0.13	0.25	0.28	0.30	0.33	
	275 - 350	X	35	0.10	0.23	0.25	0.28	0.30	
	Stainless Steel 300 Series 304, 316, 17-4PH, etc.	135 - 185	X	40	0.13	0.18	0.20	0.23	0.30
		185 - 275	X	35	0.10	0.15	0.18	0.20	0.28
	PH Stainless 17-4, 13-8, 15-5	275-350	X	30	0.08	0.10	0.15	0.20	0.25
		350-425	X	25	0.08	0.10	0.15	0.20	0.25
Super Duplex Stainless Steel	135 - 185	X	40	0.13	0.13	0.15	0.15	0.18	
	185 - 275	X	35	0.10	0.13	0.13	0.15	0.15	
H Wear Plate Hardox, AR400, T-1, etc.	400	X	20	0.08	0.15	0.20	0.23	0.30	
	500	X	15	0.05	0.13	0.18	0.20	0.25	
	600	X	-	-	-	-	-	-	
	Hardened Steel	300 - 400	X	30	0.08	0.15	0.20	0.23	0.30
400 - 500		X	15	0.05	0.13	0.18	0.20	0.25	
K SG / Nodular Cast Iron	120 - 150	X	90	0.18	0.30	0.41	0.51	0.61	
	150 - 200	X	85	0.15	0.28	0.36	0.46	0.56	
	200 - 220	X	75	0.15	0.23	0.30	0.41	0.46	
	220 - 260	X	65	0.13	0.18	0.23	0.30	0.36	
	260 - 320	X	55	0.10	0.15	0.18	0.23	0.30	
N Cast Aluminum	30	X	185	0.20	0.33	0.41	0.51	0.56	
	180	X	90	0.20	0.33	0.41	0.46	0.56	
	Wrought Aluminum	30	X	275	0.23	0.33	0.43	0.51	0.61
		180	X	185	0.13	0.18	0.25	0.33	0.41
	Aluminum Bronze	100 - 200	X	90	0.15	0.28	0.36	0.46	0.56
		200 - 250	X	75	0.13	0.18	0.23	0.30	0.36
	Brass	100	X	150	0.18	0.30	0.41	0.51	0.61
Copper	60	X	100	0.05	0.08	0.15	0.20	0.25	

7xD and 10xD Adjustment Example (0.80 Adjustment)

Data • Adjustment Value	Speed/Feed (7xD)
100 M/min • 0.80	= 80 M/min
0.2 mm/rev • 0.80	= 0.16 mm/rev

12xD and 15xD Adjustment Example (0.70 Adjustment)

Speed • Adjustment Value	Speed/Feed (12xD)
100 M/min • 0.70	= 70 M/min
0.2 mm/rev • 0.70	= 0.14 mm/rev

Coolant Recommendations

Series	STUB, 3xD, 5xD		7xD, 10xD		12xD, 15xD	
	Pressure BAR	Flow Rate LPM	Pressure BAR	Flow Rate LPM	Pressure BAR	Flow Rate LPM
Z	31	15	34	22	45	30
0	24	22	31	34	34	45
1	21	30	27	38	34	45
2	17	38	24	49	31	60
3	14	45	21	53	27	68

⚠ WARNING

Tool failure can cause serious injury. To prevent:

- When using holders without support bushing, use a short T-A Pro holder to establish an initial hole that is a minimum of 2 diameters deep.
- Do not rotate tool holders more than 50 RPM unless it is engaged with the workpiece or fixture.

Visit www.alliedmachine.com/DeepHoleGuidelines for the most up-to-date information and procedures.

Factory technical assistance is available for your specific applications through our Application Engineering department. email: engineering.eu@alliedmachine.com

IMPORTANT: The speeds and feeds listed above are a general starting point for all applications. Refer to the coolant recommendation chart for coolant requirements to run at the recommended speeds and feeds. Factory technical assistance is available through our Application Engineering department. For 7xD, 10xD, 12xD, and 15xD holder lengths, see adjustment example above.

A
DRILLING
B
BORING
C
REAMING
D
BURNISHING
E
THREADING
X
SPECIALS



Carbide Recommended Drilling Data | Imperial (inch)

A
DRILLING

B
BORING

C
REAMING

D
BURNISHING

E
THREADING

X
SPECIALS

Material	Hardness (BHN)	Insert Grade	Speed (SFM)	Feed Rate (IPR) by Diameter				
				3/8" - 33/64"	1/2" - 11/16"	45/64" - 15/16"	31/32" - 1-3/8"	1-13/32" - 1-7/8"
Free-Machining Steel 1118, 1215, 12L14, etc.	100 - 150	P	475	0.007	0.010	0.013	0.016	0.020
	150 - 200	P	440	0.007	0.010	0.013	0.016	0.020
	200 - 250	P	410	0.006	0.010	0.013	0.016	0.020
Low-Carbon Steel 1010, 1020, 1025, 1522, 1144, etc.	85 - 125	P	425	0.006	0.009	0.012	0.015	0.019
	125 - 175	P	410	0.006	0.009	0.012	0.015	0.019
	175 - 225	P	385	0.005	0.008	0.010	0.014	0.018
	225 - 275	P	355	0.005	0.008	0.010	0.014	0.018
Medium-Carbon Steel 1030, 1040, 1050, 1527, 1140, 1151, etc.	125 - 175	P	410	0.006	0.009	0.012	0.015	0.019
	175 - 225	P	385	0.005	0.008	0.010	0.014	0.018
	225 - 275	P	355	0.005	0.008	0.010	0.014	0.018
	275 - 325	P	330	0.004	0.007	0.009	0.012	0.016
Alloy Steel 4140, 5140, 8640, etc.	125 - 175	P	420	0.006	0.009	0.012	0.014	0.017
	175 - 225	P	390	0.005	0.008	0.011	0.014	0.017
	225 - 275	P	360	0.005	0.008	0.011	0.014	0.017
	275 - 325	P	340	0.004	0.007	0.010	0.012	0.015
	325 - 375	P	310	0.003	0.007	0.010	0.012	0.015
High-Strength Alloy 4340, 4330V, 300M, etc.	225 - 300	P	350	0.004	0.007	0.010	0.013	0.015
	300 - 350	P	325	0.003	0.006	0.009	0.012	0.014
	350 - 400	P	300	0.003	0.006	0.008	0.011	0.013
Structural Steel A36, A285, A516, etc.	100 - 150	P	400	0.006	0.010	0.012	0.014	0.018
	150 - 250	P	340	0.005	0.009	0.010	0.012	0.016
	250 - 350	P	280	0.004	0.008	0.009	0.010	0.014
Tool Steel H-13, H-21, A-4, S-3, etc.	150 - 200	P	220	0.004	0.006	0.008	0.010	0.012
	200 - 250	P	180	0.004	0.006	0.008	0.010	0.012
High-Temp Alloy Hastelloy B, Inconel 600, etc.	140 - 220	M	110	0.002	0.005	0.007	0.008	0.009
	220 - 310	M	85	0.002	0.003	0.005	0.006	0.007
	140 - 220	M	150	0.003	0.004	0.007	0.008	0.009
		M	120	0.003	0.003	0.005	0.006	0.007
	Aerospace Alloy S82	185 - 275	M	150	0.003	0.004	0.007	0.008
275 - 350		M	120	0.003	0.003	0.005	0.006	0.007

7xD and 10xD Adjustment Example (0.80 Adjustment)

Data • Adjustment Value	Speed/Feed (7xD)
200 SFM • 0.80	= 160 SFM
0.008 IPR • 0.80	= 0.0064 IPR

12xD and 15xD Adjustment Example (0.70 Adjustment)

Speed • Adjustment Value	Speed/Feed (12xD)
200 SFM • 0.70	= 140 SFM
0.008 IPR • 0.70	= 0.0056 IPR

Coolant Recommendations

Series	STUB, 3xD, 5xD		7xD, 10xD		12xD, 15xD	
	Pressure PSI	Flow Rate GPM	Pressure PSI	Flow Rate GPM	Pressure PSI	Flow Rate GPM
Z	450	4	550	6	650	8
0	350	6	450	9	550	12
1	300	8	400	10	500	12
2	250	10	350	13	450	16
3	200	12	300	14	400	18

⚠ WARNING

Tool failure can cause serious injury. To prevent:

- When using holders without support bushing, use a short T-A Pro holder to establish an initial hole that is a minimum of 2 diameters deep.
- Do not rotate tool holders more than 50 RPM unless it is engaged with the workpiece or fixture.

Visit www.alliedmachine.com/DeepHoleGuidelines for the most up-to-date information and procedures.

Factory technical assistance is available for your specific applications through our Application Engineering department. email: engineering.eu@alliedmachine.com

IMPORTANT: The speeds and feeds listed above are a general starting point for all applications. Refer to the coolant recommendation chart for coolant requirements to run at the recommended speeds and feeds. Factory technical assistance is available through our Application Engineering department. For 7xD, 10xD, 12xD, and 15xD holder lengths, see adjustment example above.

Carbide Recommended Drilling Data | Imperial (inch)

	Material	Hardness (BHN)	Insert Grade	Speed (SFM)	Feed Rate (IPR) by Diameter				
					3/8" - 33/64"	1/2" - 11/16"	45/64" - 15/16"	31/32" - 1-3/8"	1-13/32" - 1-7/8"
M	Stainless Steel 400 Series 416, 420, etc.	185 - 275	M	280	0.005	0.010	0.011	0.012	0.013
		275 - 350	M	230	0.004	0.009	0.010	0.011	0.012
	Stainless Steel 300 Series 304, 316, 17-4PH, etc.	135 - 185	M	280	0.003	0.004	0.005	0.008	0.011
		185 - 275	M	250	0.002	0.003	0.004	0.007	0.009
	Stainless Steel 300L Series 304L, 316L, etc.	135 - 185	M	325	0.003	0.004	0.005	0.008	0.011
		185 - 275	M	280	0.002	0.003	0.004	0.007	0.009
PH Stainless 17-4, 13-8, 15-5	275-350	M	280	0.003	0.004	0.005	0.008	0.011	
	350-425	M	250	0.002	0.003	0.004	0.007	0.009	
Super Duplex Stainless Steel	135 - 185	M	250	0.003	0.004	0.005	0.008	0.011	
	185 - 275	M	230	0.002	0.003	0.004	0.007	0.009	
H	Wear Plate Hardox, AR400, T-1, etc.	400	P	70	0.003	0.006	0.008	0.009	0.012
		500	P	45	0.002	0.005	0.007	0.008	0.010
		600	N/A	-	-	-	-	-	-
	Hardened Steel	300 - 400	P	95	0.003	0.006	0.008	0.009	0.012
400 - 500		P	45	0.002	0.005	0.007	0.008	0.010	
K	SG / Nodular Cast Iron	120 - 150	K	600	0.007	0.012	0.016	0.020	0.024
		150 - 200	K	550	0.006	0.011	0.014	0.018	0.022
		200 - 220	K	500	0.006	0.009	0.012	0.016	0.018
		220 - 260	K	450	0.005	0.007	0.009	0.012	0.014
		260 - 320	K	400	0.004	0.006	0.007	0.009	0.012
N	Cast Aluminum	30	N	1100	0.008	0.013	0.016	0.020	0.022
		180	N	600	0.008	0.013	0.016	0.018	0.022
	Wrought Aluminum	30	N	1100	0.009	0.013	0.017	0.020	0.024
		180	N	600	0.005	0.007	0.010	0.013	0.016
	Aluminum Bronze	100 - 200	N	500	0.006	0.011	0.014	0.018	0.022
		200 - 250	N	300	0.005	0.007	0.009	0.012	0.014
	Brass	100	N	650	0.007	0.012	0.016	0.020	0.024
Copper	60	N	430	0.002	0.003	0.006	0.008	0.010	

7xD and 10xD Adjustment Example (0.80 Adjustment)

Data • Adjustment Value	Speed/Feed (7xD)
200 SFM • 0.80	= 160 SFM
0.008 IPR • 0.80	= 0.0064 IPR

12xD and 15xD Adjustment Example (0.70 Adjustment)

Speed • Adjustment Value	Speed/Feed (12xD)
200 SFM • 0.70	= 140 SFM
0.008 IPR • 0.70	= 0.0056 IPR

Coolant Recommendations

Series	STUB, 3xD, 5xD		7xD, 10xD		12xD, 15xD	
	Pressure PSI	Flow Rate GPM	Pressure PSI	Flow Rate GPM	Pressure PSI	Flow Rate GPM
Z	450	4	550	6	650	8
0	350	6	450	9	550	12
1	300	8	400	10	500	12
2	250	10	350	13	450	16
3	200	12	300	14	400	18

⚠ WARNING Tool failure can cause serious injury. To prevent:

- When using holders without support bushing, use a short T-A Pro holder to establish an initial hole that is a minimum of 2 diameters deep.
- Do not rotate tool holders more than 50 RPM unless it is engaged with the workpiece or fixture.

Visit www.alliedmachine.com/DeepHoleGuidelines for the most up-to-date information and procedures.

Factory technical assistance is available for your specific applications through our Application Engineering department. *email: engineering.eu@alliedmachine.com*

IMPORTANT: The speeds and feeds listed above are a general starting point for all applications. Refer to the coolant recommendation chart for coolant requirements to run at the recommended speeds and feeds. Factory technical assistance is available through our Application Engineering department. For 7xD, 10xD, 12xD, and 15xD holder lengths, see adjustment example above.

A
DRILLING
B
BORING
C
REAMING
D
BURNISHING
E
THREADING
X
SPECIALS



High-Speed Steel Recommended Drilling Data | Imperial (inch)

Material	Hardness (BHN)	Insert Grade	Speed (SFM)	Feed Rate (IPR) by Diameter					
				3/8" - 33/64"	1/2" - 11/16"	45/64" - 15/16"	31/32" - 1-3/8"	1-13/32" - 1-7/8"	
Free-Machining Steel 1118, 1215, 12L14, etc.	100 - 150	X	350	0.007	0.010	0.013	0.016	0.020	
	150 - 200	X	325	0.007	0.010	0.013	0.016	0.020	
	200 - 250	X	300	0.006	0.010	0.013	0.016	0.020	
Low-Carbon Steel 1010, 1020, 1025, 1522, 1144, etc.	85 - 125	X	315	0.006	0.009	0.012	0.015	0.019	
	125 - 175	X	300	0.006	0.009	0.012	0.015	0.019	
	175 - 225	X	285	0.005	0.008	0.010	0.014	0.018	
	225 - 275	X	265	0.005	0.008	0.010	0.014	0.018	
Medium-Carbon Steel 1030, 1040, 1050, 1527, 1140, 1151, etc.	125 - 175	X	300	0.006	0.009	0.012	0.015	0.019	
	175 - 225	X	285	0.005	0.008	0.010	0.014	0.018	
	225 - 275	X	265	0.005	0.008	0.010	0.014	0.018	
	275 - 325	X	235	0.004	0.007	0.009	0.012	0.016	
Alloy Steel 4140, 5140, 8640, etc.	125 - 175	X	250	0.006	0.009	0.012	0.014	0.017	
	175 - 225	X	235	0.005	0.008	0.011	0.014	0.017	
	225 - 275	X	220	0.005	0.008	0.011	0.014	0.017	
	275 - 325	X	205	0.004	0.007	0.010	0.012	0.015	
	325 - 375	X	190	0.003	0.007	0.010	0.012	0.015	
High-Strength Alloy 4340, 4330V, 300M, etc.	225 - 300	X	135	0.004	0.007	0.010	0.013	0.015	
	300 - 350	X	110	0.003	0.006	0.009	0.012	0.014	
	350 - 400	X	90	0.003	0.006	0.008	0.011	0.013	
Structural Steel A36, A285, A516, etc.	100 - 150	X	250	0.006	0.010	0.012	0.014	0.018	
	150 - 250	X	210	0.005	0.009	0.010	0.012	0.016	
	250 - 350	X	175	0.004	0.008	0.009	0.010	0.014	
Tool Steel H-13, H-21, A-4, S-3, etc.	150 - 200	X	145	0.004	0.006	0.008	0.010	0.012	
	200 - 250	X	120	0.004	0.006	0.008	0.010	0.012	
High-Temp Alloy Hastelloy B, Inconel 600, etc.	140 - 220	X	45	0.003	0.007	0.008	0.010	0.012	
	220 - 310	X	40	0.003	0.006	0.007	0.008	0.010	
	Titanium Alloy	140 - 220	X	60	0.003	0.007	0.008	0.010	0.012
		220 - 310	X	50	0.003	0.006	0.007	0.008	0.010
	Aerospace Alloy S82	185 - 275	X	125	0.005	0.008	0.009	0.010	0.014
275 - 350		X	110	0.004	0.007	0.008	0.008	0.012	

7xD and 10xD Adjustment Example (0.80 Adjustment)

Data • Adjustment Value	Speed/Feed (7xD)
200 SFM • 0.80	= 160 SFM
0.008 IPR • 0.80	= 0.0064 IPR

12xD and 15xD Adjustment Example (0.70 Adjustment)

Speed • Adjustment Value	Speed/Feed (12xD)
200 SFM • 0.70	= 140 SFM
0.008 IPR • 0.70	= 0.0056 IPR

Coolant Recommendations

Series	STUB, 3xD, 5xD		7xD, 10xD		12xD, 15xD	
	Pressure PSI	Flow Rate GPM	Pressure PSI	Flow Rate GPM	Pressure PSI	Flow Rate GPM
Z	450	4	550	6	650	8
0	350	6	450	9	550	12
1	300	8	400	10	500	12
2	250	10	350	13	450	16
3	200	12	300	14	400	18

⚠ WARNING Tool failure can cause serious injury. To prevent:

- When using holders without support bushing, use a short T-A Pro holder to establish an initial hole that is a minimum of 2 diameters deep.
- Do not rotate tool holders more than 50 RPM unless it is engaged with the workpiece or fixture.

Visit www.alliedmachine.com/DeepHoleGuidelines for the most up-to-date information and procedures.

Factory technical assistance is available for your specific applications through our Application Engineering department. *email: engineering.eu@alliedmachine.com*

IMPORTANT: The speeds and feeds listed above are a general starting point for all applications. Refer to the coolant recommendation chart for coolant requirements to run at the recommended speeds and feeds. Factory technical assistance is available through our Application Engineering department. For 7xD, 10xD, 12xD, and 15xD holder lengths, see adjustment example above.

High-Speed Steel Recommended Drilling Data | Imperial (inch)

Material	Hardness (BHN)	Insert Grade	Speed (SFM)	Feed Rate (IPR) by Diameter					
				3/8" - 33/64"	1/2" - 11/16"	45/64" - 15/16"	31/32" - 1-3/8"	1-13/32" - 1-7/8"	
M Stainless Steel 400 Series 416, 420, etc.	185 - 275	X	125	0.005	0.010	0.011	0.012	0.013	
	275 - 350	X	110	0.004	0.009	0.010	0.011	0.012	
	Stainless Steel 300 Series 304, 316, 17-4PH, etc.	135 - 185	X	125	0.005	0.007	0.008	0.009	0.012
		185 - 275	X	110	0.004	0.006	0.007	0.008	0.011
	PH Stainless 17-4, 13-8, 15-5	275-350	X	95	0.003	0.004	0.006	0.008	0.010
		350-425	X	75	0.003	0.004	0.006	0.008	0.010
Super Duplex Stainless Steel	135 - 185	X	125	0.005	0.005	0.006	0.006	0.007	
	185 - 275	X	110	0.004	0.005	0.005	0.006	0.006	
H Wear Plate Hardox, AR400, T-1, etc.	400	X	60	0.003	0.006	0.008	0.009	0.012	
	500	X	45	0.002	0.005	0.007	0.008	0.010	
	600	X	-	-	-	-	-	-	
	Hardened Steel	300 - 400	X	75	0.003	0.006	0.008	0.009	0.012
400 - 500		X	45	0.002	0.005	0.007	0.008	0.010	
K SG / Nodular Cast Iron	120 - 150	X	300	0.007	0.012	0.016	0.020	0.024	
	150 - 200	X	275	0.006	0.011	0.014	0.018	0.022	
	200 - 220	X	240	0.006	0.009	0.012	0.016	0.018	
	220 - 260	X	215	0.005	0.007	0.009	0.012	0.014	
	260 - 320	X	175	0.004	0.006	0.007	0.009	0.012	
N Cast Aluminum	30	X	600	0.008	0.013	0.016	0.020	0.022	
	180	X	300	0.008	0.013	0.016	0.018	0.022	
	Wrought Aluminum	30	X	900	0.009	0.013	0.017	0.020	0.024
		180	X	600	0.005	0.007	0.010	0.013	0.016
	Aluminum Bronze	100 - 200	X	300	0.006	0.011	0.014	0.018	0.022
		200 - 250	X	250	0.005	0.007	0.009	0.012	0.014
	Brass	100	X	485	0.007	0.012	0.016	0.020	0.024
Copper	60	X	320	0.002	0.003	0.006	0.008	0.010	

7xD and 10xD Adjustment Example (0.80 Adjustment)

Data • Adjustment Value	Speed/Feed (7xD)
200 SFM • 0.80	= 160 SFM
0.008 IPR • 0.80	= 0.0064 IPR

12xD and 15xD Adjustment Example (0.70 Adjustment)

Speed • Adjustment Value	Speed/Feed (12xD)
200 SFM • 0.70	= 140 SFM
0.008 IPR • 0.70	= 0.0056 IPR

Coolant Recommendations

Series	STUB, 3xD, 5xD		7xD, 10xD		12xD, 15xD	
	Pressure PSI	Flow Rate GPM	Pressure PSI	Flow Rate GPM	Pressure PSI	Flow Rate GPM
Z	450	4	550	6	650	8
0	350	6	450	9	550	12
1	300	8	400	10	500	12
2	250	10	350	13	450	16
3	200	12	300	14	400	18

⚠ WARNING

Tool failure can cause serious injury. To prevent:

- When using holders without support bushing, use a short T-A Pro holder to establish an initial hole that is a minimum of 2 diameters deep.
- Do not rotate tool holders more than 50 RPM unless it is engaged with the workpiece or fixture.

Visit www.alliedmachine.com/DeepHoleGuidelines for the most up-to-date information and procedures.

Factory technical assistance is available for your specific applications through our Application Engineering department. *email: engineering.eu@alliedmachine.com*

IMPORTANT: The speeds and feeds listed above are a general starting point for all applications. Refer to the coolant recommendation chart for coolant requirements to run at the recommended speeds and feeds. Factory technical assistance is available through our Application Engineering department. For 7xD, 10xD, 12xD, and 15xD holder lengths, see adjustment example above.



Tap Drill Information and Formulas | Metric (mm)

Tap Size	Tap Drill Size	Decimal Equivalent (inch)	* Theo % Thread	Probable Mean Oversize	Probable Hole Size	** Probable % Thread
12 X 1.25	27/64	0.4219	79%	0.075mm	10.79mm	74%
	10.8mm	0.4252	74%	0.075mm	10.88mm	69%
14 X 2.0	15/32	0.4688	81%	0.075mm	11.98mm	78%
	12.0mm	0.4724	77%	0.075mm	12.08mm	74%
14 X 1.5	12.5mm	0.4921	77%	0.075mm	12.58mm	73%
16 X 2.0	14.0mm	0.5512	77%	0.075mm	14.08mm	74%
16 X 1.5	14.5mm	0.5709	77%	0.075mm	14.58mm	73%
	37/64	0.5781	68%	0.075mm	14.76mm	64%
18 X 2.5	15.5 mm	0.6102	77%	0.075mm	15.58mm	75%
18 X 1.5	16.5mm	0.6496	77%	0.075mm	16.58mm	73%
	21/32	0.6563	68%	0.075mm	16.75mm	64%
20 X 2.5	11/16	0.6875	78%	0.075mm	17.54mm	76%
	17.5 mm	0.6890	77%	0.075mm	17.58mm	74%
20 X 1.5	18.5mm	0.7283	77%	0.075mm	18.58mm	73%
	47/64	0.7344	69%	0.075mm	18.66mm	65%
22 X 2.5	49/64	0.7656	79%	0.075mm	19.52mm	76%
	19.5 mm	0.7677	77%	0.075mm	19.58mm	75%
22 X 1.5	20.5mm	0.8071	77%	0.075mm	20.58mm	73%
	13/16	0.8125	70%	0.075mm	20.71mm	66%
24 X 3	13/16	0.8125	86%	0.075mm	20.71mm	84%
	21.0 mm	0.8268	76%	0.075mm	21.08mm	75%
24 X 2	22.0mm	0.8661	77%	0.075mm	22.08mm	74%
	7/8	0.8750	68%	0.075mm	22.30mm	65%
27 X 3	24.0mm	0.9449	77%	0.075mm	24.08mm	75%

Formulas

1.	RPM	= (318.47 • M/min) / DIA
	where:	
	RPM	= revolutions per minute (rev/min)
	M/min	= speed (M/min)
	DIA	= diameter of drill (mm)
2.	mm/min	= RPM • mm/rev
	where:	
	mm/min	= mm per minute (mm/min)
	RPM	= revolutions per minute (rev/min)
	mm/rev	= feed rate (mm/rev)
3.	M/min	= RPM • 0.003 • DIA
	where:	
	M/min	= speed (M/min)
	RPM	= revolutions per minute (rev/min)
	DIA	= diameter of drill (mm)
4.	Thrust	= 154 • (mm/rev) • DIA • K _m
	where:	
	Thrust	= axial thrust (N)
	mm/rev	= feed rate (mm/rev)
	DIA	= diameter of drill (mm)
	K _m	= specific cutting energy (kPa)
5.	Tool Power	= ((mm/rev) • RPM • K _m • DIA ²) / 218604.8
	where:	
	Tool Power	= tool power (HP)
	mm/rev	= feed rate (mm/rev)
	RPM	= revolutions per minute (rev/min)
	K _m	= specific cutting energy (kPa)
	DIA	= diameter of drill (mm)

BSP and ISO 7-1

Tap Size	Tap Drill Size	Decimal Equivalent	* Theo % Thread	Probable Mean Oversize	Probable Hole Size	** Probable % Thread
1/4-19	7/16	0.4375	-	0.075mm	11.19 mm	-
3/8-19	37/64	0.5781	-	0.075mm	14.76 mm	-
1/2-14	23/32	0.7188	-	0.075mm	18.33 mm	-
3/4-14	15/16	0.9375	-	0.075mm	23.89 mm	-

* Based on nominal tap drill diameter

** Based on 0.075mm probable mean oversize

To calculate the percent of full thread for a given hole diameter:

$$\% \text{ Thread} = \frac{76.93}{\text{Pitch (mm)}} \cdot (\text{Basic major diameter} - \text{Drill hole size})$$

Notes

- The above tap drill information represents probable thread percentages for the standard tap drills stocked at Allied Machine. Special insert diameters may be required in order to meet a user specific percentage of thread requirement.
- The .075mm probable mean oversize hole condition is based on optimum cutting conditions. Probable percent of full thread may vary based on less ideal cutting conditions.
- The table and equations on this page are found in the *Machinery's Handbook*. Permission to simplify and print the equations is granted by the editor of the *Machinery's Handbook*.

Material Constants

Type of Material	Hardness	Km (kPa)
Plain Carbon and Alloy Steel	85 - 200 BHN	5.45
	200 - 275 BHN	6.48
	275 - 375 BHN	6.89
	375 - 425 BHN	7.93
High-Temperature Alloys	-	9.93
Titanium Alloy	-	4.96
Stainless Steels	135 - 275 BHN	6.48
	30 - 45 RC	7.45
Cast Iron	100 - 200 BHN	3.45
	200 - 300 BHN	7.45
Copper Alloy	20 - 80 RB	2.96
	80 - 100 RB	4.96
Aluminum Alloy	-	1.52
Magnesium Alloy	-	1.10

Tap Drill Information and Formulas | Imperial (inch)

American - Unified Inch Screw Thread

Tap Size	Tap Drill Size	Decimal Equivalent	* Theo % Thread	Probable Mean Oversize	Probable Hole Size	** Probable % Thread
1/2 - 20	29/64	0.4531	72%	0.003	0.4561	68%
9/16 - 12	12.0mm	0.4724	72%	0.003	0.4754	69%
	31/64	0.4844	83%	0.003	0.4874	80%
9/16 - 18	1/2	0.5000	87%	0.003	0.5030	82%
	13.0mm	0.5118	70%	0.003	0.5148	66%
	31/64	0.5156	65%	0.003	0.5186	61%
5/8 - 11	17/32	0.5313	79%	0.003	0.5343	77%
5/8 - 12	35/64	0.5469	72%	0.003	0.5499	69%
5/8 - 18	9/16	0.5625	87%	0.003	0.5655	82%
	14.5mm	0.5709	75%	0.003	0.5739	71%
	37/64	0.5781	65%	0.003	0.5811	61%
11/16 - 12	39/64	0.6094	72%	0.003	0.6124	69%
3/4 - 10	41/64	0.6406	84%	0.003	0.6436	82%
	16.5mm	0.6496	77%	0.003	0.6526	75%
	21/32	0.6563	72%	0.003	0.6593	70%
3/4 - 12	43/64	0.6719	72%	0.003	0.6749	69%
3/4 - 16	11/16	0.6875	77%	0.003	0.6905	73%
	17.5mm	0.6890	75%	0.003	0.6920	71%
7/8 - 9	49/64	0.7656	76%	0.003	0.7686	74%
	25/32	0.7813	65%	0.003	0.7843	63%
7/8 - 14	51/64	0.7969	84%	0.003	0.7999	81%
	13/16	0.8125	67%	0.003	0.8155	64%
15/16 - 12	55/64	0.8594	72%	0.003	0.8624	69%
15/16 - 20	57/64	0.8906	72%	0.003	0.8936	68%
1 - 8	22.0mm	0.8661	82%	0.003	0.8691	81%
	7/8	0.8750	77%	0.003	0.8780	75%
	57/64	0.8906	67%	0.003	0.8936	65%
1 - 12	29/32	0.9063	87%	0.003	0.9093	84%
	59/64	0.9219	72%	0.003	0.9249	69%
1 - 14	15/16	0.9375	67%	0.003	0.9405	64%
1-1/8 - 12	1-1/32	1.0313	87%	0.003	1.0343	84%
	1-3/64	1.0469	72%	0.003	1.0499	69%
1-1/4 - 7	1-7/64	1.1094	76%	0.003	1.1124	74%

Taper Pipe Thread (NPT)

Tap Size	Tap Drill Size	Decimal Equivalent	* Theo % Thread	Probable Mean Oversize	Probable Hole Size	** Probable % Thread
1/4 - 18	7/16	0.4375	-	0.003	0.4405	-
3/8 - 18	9/16	0.5625	-	0.003	0.5655	-
1/2 - 14	45/64	0.7031	-	0.003	0.7061	-
3/4 - 14	29/32	0.9063	-	0.003	0.9093	-

* Based on nominal tap drill diameter

** Based on .003" probable mean oversize

To calculate the percent of full thread for a given hole diameter:

% Thread =

$$\# \text{ of threads per inch} \cdot \frac{(\text{Basic major diameter of thread} - \text{Drill hole size})}{.0130}$$

Notes

- The above tap drill information represents probable thread percentages for the standard tap drills stocked at Allied Machine. Special insert diameters may be required in order to meet a user specific percentage of thread requirement.
- The .003 probable mean oversize hole condition is based on optimum cutting conditions. Probable percent of full thread may vary based on less ideal cutting conditions.
- The table and equations on this page are found in the *Machinery's Handbook*. Permission to simplify and print the equations is granted by the editor of the *Machinery's Handbook*.

Formulas

1.	RPM	= (3.82 • SFM) / DIA
	where:	
	RPM	= revolutions per minute (rev/min)
	SFM	= speed (ft/min)
	DIA	= diameter of drill (inch)
2.	IPM	= RPM • IPR
	where:	
	IPM	= inches per minute (in/min)
	RPM	= revolutions per minute (rev/min)
	IPR	= feed rate (in/rev)
3.	SFM	= RPM • 0.262 • DIA
	where:	
	SFM	= speed (ft/min)
	RPM	= revolutions per minute (rev/min)
	DIA	= diameter of drill (inch)
4.	Thrust	= 153,700 • IPR • DIA • Km
	where:	
	Thrust	= axial thrust (lbs)
	IPR	= feed rate (in/rev)
	DIA	= diameter of drill (inch)
	Km	= specific cutting energy (lbs/in ²)
5.	Tool Power	= .6991 • IPR • RPM • Km • DIA ²
	where:	
	Tool Power	= tool power (HP)
	IPR	= feed rate (in/rev)
	RPM	= revolutions per minute (rev/min)
	Km	= specific cutting energy (lbs/in ²)
	DIA	= diameter of drill (inch)

Material Constants

Type of Material	Hardness	Km (lbs/in ²)
Plain Carbon and Alloy Steel	85 - 200 BHN	0.79
	200 - 275 BHN	0.94
	275 - 375 BHN	1.00
	375 - 425 BHN	1.15
High-Temperature Alloys	-	1.44
Titanium Alloy	-	0.72
Stainless Steels	135 - 275 BHN	0.94
	30 - 45 RC	1.08
Cast Iron	100 - 200 BHN	0.50
	200 - 300 BHN	1.08
Copper Alloy	20 - 80 RB	0.43
	80 - 100 RB	0.72
Aluminum Alloy	-	0.22
Magnesium Alloy	-	0.16

Deep Hole Drilling Guidelines

T-A Pro | 10xD, 12xD, and 15xD Holders

A

DRILLING

- 1. Pilot Hole**
 100 % RPM
 100% mm/rev (IPR)

Establish the pilot hole using the same diameter short drill to a depth of 2xD minimum. Utilize a pilot drill with the same or larger included point angle.

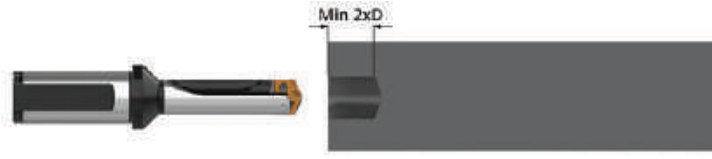

Coolant ON

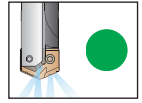

B

BORING

- 2. Feed-in**
 50 RPM max
 300 mm/min (12 IPM)

Feed the longer drill within 1.5mm (1/16") short of the established pilot hole bottom at a **maximum of 50 RPM** and 300 mm/min (12 IPM) feed rate.



Coolant OFF

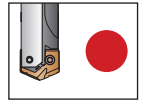

C

REAMING

- 3. Deep Hole Transition Drilling**
 50 % RPM
 75% mm/rev (IPR)

Drill additional 1xD past the bottom of the pilot hole at 50% reduction of recommended speed and 25% reduction of recommended feed. Minimum of one second dwell is required to meet full speed before feeding.



Coolant ON

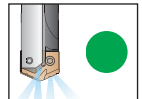

D

BURNISHING

- 4. Deep Hole Drilling - Blind**
 100% RPM
 100% IPR (mm/rev)

Drill to full depth at recommended speed and feed for longer drill according to Allied speed and feed charts. **No peck cycle recommended.**



Coolant ON

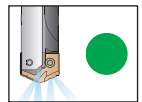

F

THREADING

- 6. Drill Retract**
 50 RPM max

Reduce speed to a **maximum of 50 RPM** before retracting from the hole.



Coolant OFF

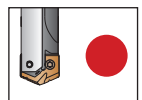

X

SPECIALS

⚠ WARNING Tool failure can cause serious injury. To prevent:

- When using holders without support bushing, use a short T-A Pro holder to establish an initial hole that is a minimum of 2 diameters deep.
- Do not rotate tool holders more than 50 RPM unless it is engaged with the workpiece or fixture.

Visit www.alliedmachine.com/DeepHoleGuidelines for the most up-to-date information and procedures.

Factory technical assistance is available for your specific applications through our Application Engineering department. email: engineering.eu@alliedmachine.com

Troubleshooting Guide

	Potential Problem																				
	Accelerated corner wear	Barber pole	Bell-mouth hole	Insert chipping	Blue chips	Built-Up Edge (BUE)	Chatter	Chip packing	Chipping of point	Damaged or broken tools	Excessive margin wear	High flank wear	Hole lead off	Hole out of position	Hole out of round	Oversize hole	Poor hole finish	Poor tool life	Power spikes - Load meter	Retract spiral	
Setup Condition	1	2	3	4	5	6	7	8	9	10	11	12	13	14	15	16	17	18	19	20	Possible Solutions
Worn or misaligned spindle (lathe, screw machine, chucker)	1		3				7		9	10	11		13			16	17			20	<ul style="list-style-type: none"> Align spindle and turret or tailstock. Repair spindle.
Use of low rigidity machine tools		2	3	4			7		9	10			13	14						20	<ul style="list-style-type: none"> Reduce penetration rate to fall within the physical limits of the machine or setup (NOTICE: Do not reduce feed below threshold of good chip formation).
Poor work piece support		2		4			7		10	11					15		17			20	<ul style="list-style-type: none"> Provide additional support for the work piece. Reduce penetration rate to fall within the physical limits of the machine or setup (NOTICE: Do not reduce feed below threshold of good chip formation).
Flood coolant, low coolant pressure, or low coolant volume	1				5	6		8		10		12				16	17	18	19		<ul style="list-style-type: none"> Run coolant through tool holder when drilling greater than 1xD. Increase coolant pressure and volume through the tool holder. Reduce penetration rate to fall within the coolant limitations (NOTICE: Do not reduce feed below threshold of good chip formation). Add a peck cycle to help clear chips.
Interrupted cuts. Entry or exit surfaces that are not perpendicular to the spindle (draft angles, parting lines, curved or stepped surfaces, cross holes, and cast or forged surfaces)				4			7		9	10	11		13	14	15	16	17	18			<ul style="list-style-type: none"> Pre-mill (spot face) entry or exit surface to remove interruption. Decrease feed as much as 50% through entry or exit interruption. Use short holders in low impact entry cuts.
Material harder than expected or running tools beyond recommended speed	1				5	6				10		12							18		<ul style="list-style-type: none"> Reduce speed. Increase coolant pressure and volume. Improve coolant condition by use of quality products and regular maintenance.
Poor material micro-structure or foreign particles (forgings and castings that have not been normalized or annealed, poorly prepared steel, flame cut parts, and sand casting)				4		6				10		12	13						18		<ul style="list-style-type: none"> Compare performance of other tools for similar wear problems, which may indicate poor micro-structure. Anneal or normalize parts to improve micro-structure for machining. Reduce feeds (NOTICE: Do not reduce feed below threshold of good chip formation).
Poor chip control								8		10	11		13			16	17	18	19		<ul style="list-style-type: none"> Increase feed to recommended levels. Contact Allied's Application Engineering group for technical recommendations. Increase coolant pressure and volume. Improve coolant condition by use of quality products and regular maintenance.
Spot drilled holes with included angle less than that matching T-A Pro or cored holes	1			4			7						13						18		<ul style="list-style-type: none"> Spot hole with short tool of same or greater included angle as T-A Pro drill insert. Reduce feed (NOTICE: Do not reduce feed below threshold of good chip formation). If possible, drill from solid.

A DRILLING
B BORING
C REAMING
D BURNISHING
E THREADING
X SPECIALS

Europe

Allied Machine & Engineering Co. (Europe) Ltd.

93 Vantage Point
Pensnett Estate
Kingswinford
West Midlands
DY6 7FR England

Phone:

+44 (0)1384 400900

Email:

enquiries.eu@alliedmachine.com

Web:

www.alliedmachine.com

Wohlhaupter GmbH

Maybachstraße 4
72636 Frickenhausen
Germany

Phone:

+49 (0)7022 408 0

Email:

info@wohlhaupter.de

Web:

www.wohlhaupter.com

United States

Allied Machine & Engineering

120 Deeds Drive
Dover OH 44622
United States

Phone:

+1 330 343 4283

Toll Free USA and Canada:

800 321 5537

Fax:

+1 330 602 3400

Toll Free USA and Canada:

800 223 5140

Allied Machine & Engineering

485 W Third Street
Dover OH 44622
United States

Phone:

+1 330 343 4283

Toll Free USA and Canada:

800 321 5537

Fax:

+1 330 364 7666
(Engineering Dept.)

Asia

Wohlhaupter India Pvt. Ltd.

B-23, 3rd Floor
B Block Community Centre
Janakpuri, New Delhi - 110058
India

Phone:

+91 11 41827044

Your local Allied Machine representative:



**ALLIED MACHINE
& ENGINEERING**

WOHLHAUPTER®

Holemaking Solutions for Today's Manufacturing