

THE EVOLUTION WF-MICRO System for DECO 10

driven and static toolholders

WF
&

Werkzeugtechnik
for professionals

WF-Micro think future

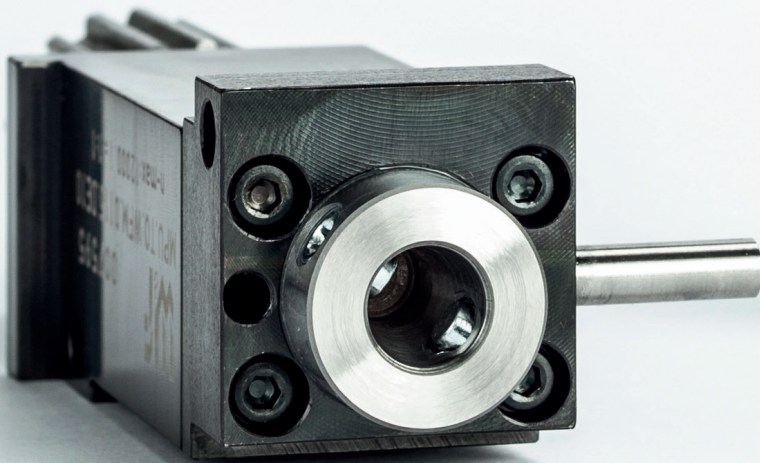

Minimize the costs of cutting tools
and increase productivity

- quick change
- presetting outside of machine
- highest runout

W&F Werkzeugtechnik GmbH
Kantstraße 4
72663 Großbettlingen/Germany

Telefon +49 (0) 7022/4058-0
Telefax +49 (0) 7022/4058-58

info@wf-werkzeugtechnik.de
wf-werkzeugtechnik.de

**NEWS
MI-01**

Modular system for TORNOS DECO 10

W&F

Werkzeugtechnik
for professionals

DECO 10 cross working

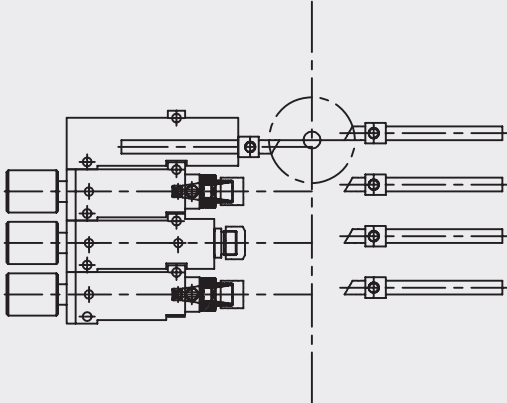

DECO 10 backside working

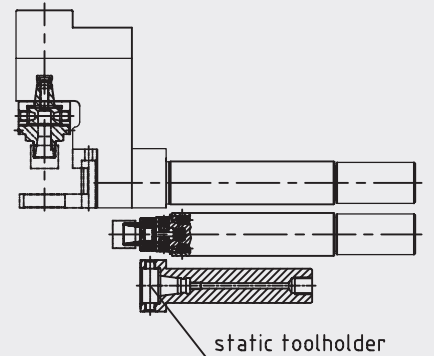

WF-Micro toolholder **NEW**

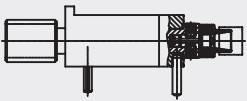

Standard toolholder

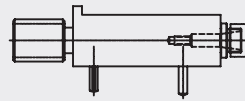

WFB-adaptors

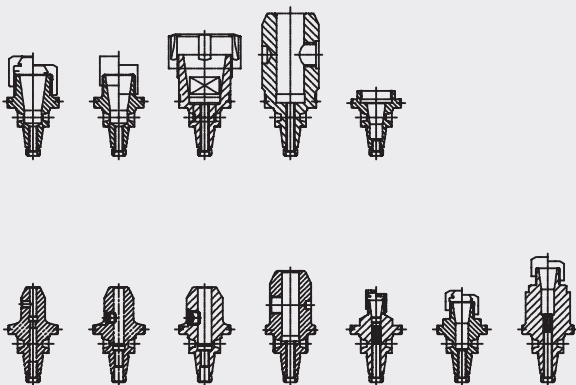

WF-Micro-adaptors

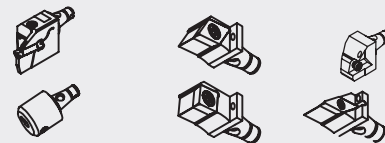

Minimize the costs of cutting tools
and increase productivity

- quick change
- presetting outside of machine
- highest runout

W&F Werkzeugtechnik GmbH
Kantstraße 4
72663 Großbettlingen/Germany

Telefon +49 (0) 7022/4058-0
Telefax +49 (0) 7022/4058-58

info@wf-werkzeugtechnik.de
wf-werkzeugtechnik.de

NEWS MI-01