

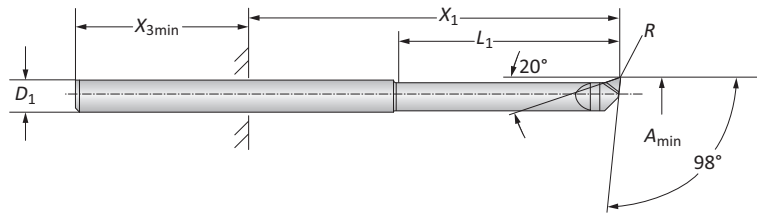

Mini Boring Bars

Diameter Range: 0.40 mm - 5.00 mm



Mini Boring Bars

	Boring Range		Boring Bar				Part No.
	A_{min}	D_1	X_1	X_{3min}	L_1	R	
	0.40	4.00*	3.00 - 26.00	16.00	2.00	0.03	081401WHC126
	0.60	4.00*	4.00 - 27.00	16.00	3.00	0.04	081402WHC126
	0.80	4.00*	5.00 - 28.00	16.00	4.00	0.04	081403WHC126
	1.00	4.00*	6.00 - 29.00	16.00	5.00	0.05	081404WHC126
	1.50	4.00*	8.50 - 31.50	16.00	7.50	0.05	081405WHC126
	2.00	4.00*	11.00 - 34.00	16.00	10.00	0.05	081406WHC126
	2.50	4.00*	13.50 - 36.50	16.00	12.50	0.05	081407WHC126
	2.80	4.00*	15.00 - 38.00	16.00	14.00	0.07	081408WHC126

*Fixture-through reducing sleeve required (B10-A: 58)

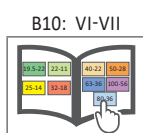
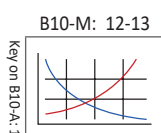

 = Metric (mm)

Mini Boring Bars

WHC05 | WHW04 | WBN150 | Diameter Range: 3.00 mm - 10.00 mm

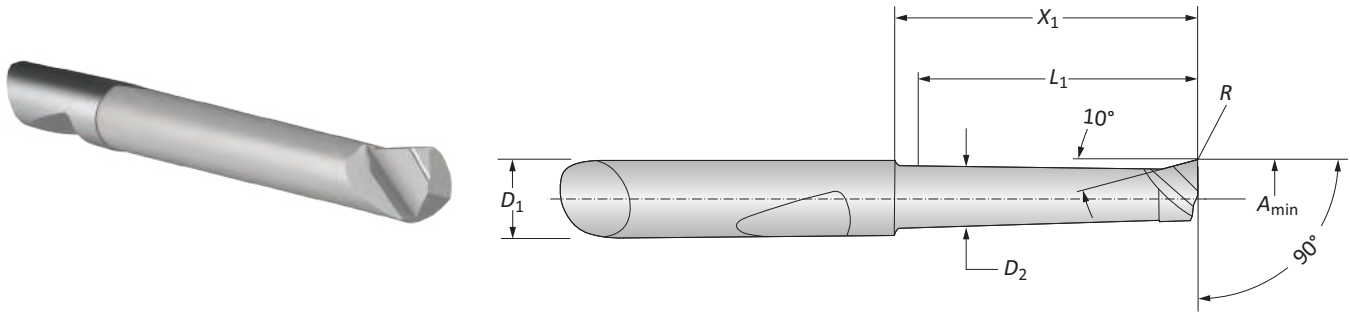

	Boring Range		Boring Bar				Part No.		
	A_{min}	D_1	D_2	X_1	L_1	R	Coated Carbide	Uncoated Carbide	CBN
E	3.00	6.00*	2.60	11.50	10.00	0.10	081306WHC05	-	081322WBN150
	3.00	6.00*	2.60	16.50	15.00	0.10	081307WHC05	081307WHW04	-
E	4.00	6.00*	3.60	12.00	10.00	0.20	081308WHC05	-	081317WBN150
	4.00	6.00*	3.60	17.00	15.00	0.20	081309WHC05	-	081341WBN150
E	4.00	6.00*	3.60	22.00	20.00	0.20	081310WHC05	081310WHW04	-
	5.00	6.00*	4.60	12.00	10.00	0.20	081311WHC05	-	081318WBN150
F	5.00	6.00*	4.60	22.00	20.00	0.20	081312WHC05	-	081319WBN150
	5.00	6.00*	4.60	32.00	30.00	0.20	081313WHC05	081313WHW04	-
F	6.00	6.00*	5.60	22.00	20.00	0.20	081314WHC05	-	081320WBN150
	6.00	6.00*	5.60	32.00	30.00	0.20	081315WHC05	-	081321WBN150
F	6.00	6.00*	5.60	42.00	40.00	0.20	081316WHC05	081316WHW04	-
	8.00	8.00*	7.60	25.00	23.00	0.20	081323WHC05	-	-
G	8.00	8.00*	7.60	50.00	48.00	0.20	081324WHC05	-	-

*Fixture-through reducing sleeve required (B10-A: 58)

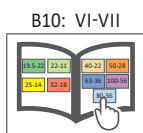
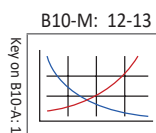

Ⓜ = Metric (mm)

Boring Bars

Steel | Diameter Range: 6.00 mm - 12.00 mm

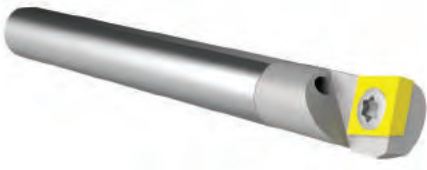

Form 101

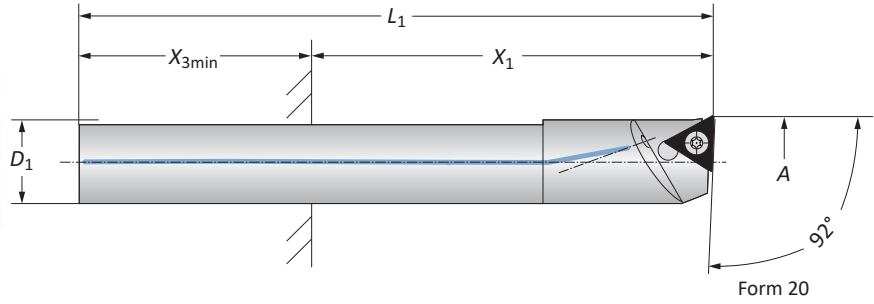

	Boring Range		Boring Bar				Part No.			
	A	D ₁	X ₁	X _{3 min}	L ₁	Weight	Insert Form	Boring Bar	Insert Form	Boring Bar
	6.00 - 8.00	5.00*	12.50 - 25.00	16.00	70.00	0.01 (kg)	211**	514032	-	-
	8.00 - 10.00	7.00*	17.50 - 35.00	16.00	81.00	0.02 (kg)	211**	514033	-	-
	10.00 - 12.00	8.00	20.00 - 40.00	19.00	85.00	0.03 (kg)	101	514003	20**	514004

*Fixture-through reducing sleeve required (B10-A: 58)

**Not suitable for indexable inserts with a radius of 0.8 mm

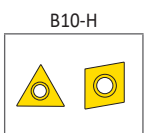
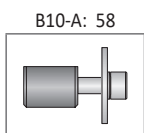
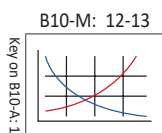

 = Metric (mm)
Inserts sold separately

Boring Bars

Carbide | Diameter Range: 6.00 mm - 12.00 mm



Form 101

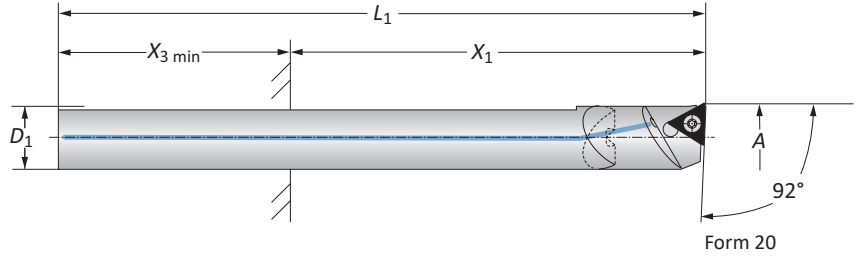

Boring Range	Boring Bar				Weight	Part No.			
	A	D ₁	X ₁	X _{3 min}		L ₁	Insert Form	Boring Bar	Insert Form
6.00 - 8.00	5.00*	12.50 - 40.00	16.00	90.00	0.02 (kg)	211**	514034	-	-
8.00 - 10.00	7.00*	21.00 - 56.00	16.00	109.00	0.05 (kg)	211**	514035	-	-
10.00 - 12.00	8.00	22.00 - 64.00	19.00	117.00	0.07 (kg)	101	514015	20**	514016

*Fixture-through reducing sleeve required (B10-A: 58)

**Not suitable for indexable inserts with a radius of 0.80 mm

