

Fraise a tronçonner

Frese a disco a troncane

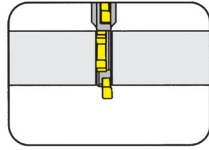

Fraise disque
Frese a disco
M310



Page/Pag.
F12-F13

Corps de fraise vissé
Fresa avvitabile
M310

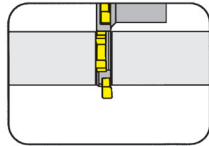

Page/Pag.
F14

Fraise à moyeu
Fresa a manicotto
M310

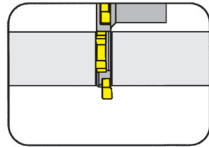

Page/Pag.
F15-F16

Plaquette amovible
Inserto
S310

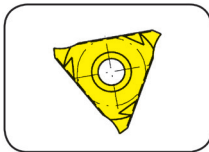

Page/Pag.
F17

F

M310



F

Fraise disque

Corps de fraise vissé

Fraise à moyeu

Largeur de rainure 3 - 5 mm

Diamètre de coupe 50 - 200 mm

Frese a disco

Fresa avvitabile

Fresa a manicotto

Larghezza della cava 3 - 5 mm

Diametro Ds 50 - 200 mm

Fraise a tronçonner

Frese a disco a troncane



Fraise disque

Frese a disco

M310

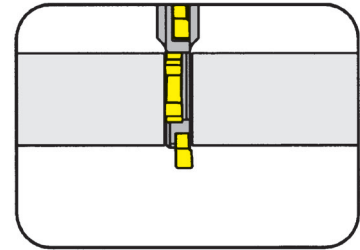

Profondeur de fraisage jusqu'à	Profondità di fresatura fino a	50 mm
Largeur de rainure	Larghezza della cava	3 mm
Diamètre de coupe	Diametro Ds	80-160 mm

Alésage (d2) rainure selon DIN 138
 Foro (d2) con chiavetta longitudinale secondo DIN 138

pour Plaquette amovible
 per Inserto

Type S310
 Tipo

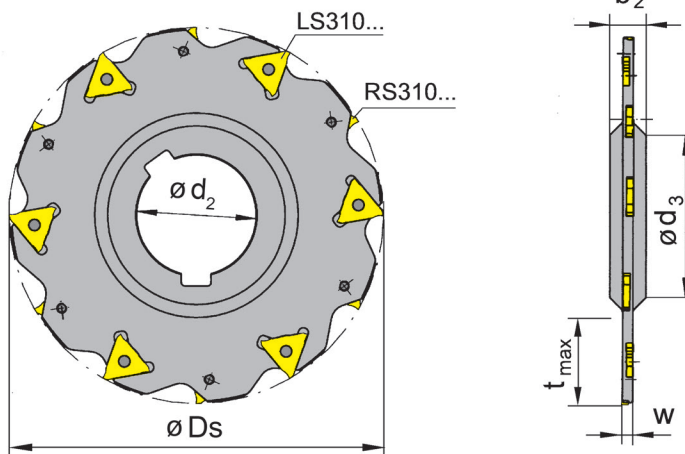

Illustration de coupe à droite représentée
 Figura = taglio destro

N° de commande Codice prodotto	Z	Ds	t _{max}	d ₂	b ₂	w	Plaquette à droite Inserto destro	Plaquette à gauche Inserto sinistro
M310.0080.27.03	8	80	18	27	8	3	4x RS310.3017.00	4x LS310.3017.00
M310.0100.32.03	10	100	25	32	8	3	5x RS310.3017.00	5x LS310.3017.00
M310.0125.40.03	12	125	32	40	10	3	6x RS310.3017.00	6x LS310.3017.00
M310.0160.40.03	16	160	50	40	10	3	8x RS310.3017.00	8x LS310.3017.00

Autres dimensions sur demande
 Dimensioni differenti sono fornibili su richiesta

Dimensions en mm
 Dimensioni in mm

Pour le couple de serrage des vis, merci de vous reporter aux Informations Techniques.
 Per il corretto serraggio dinamometrico del portainsero consultare le Informazioni Tecniche.

Pièces Détachées

Ricambi

Fraise disque Frese a disco	Vis de serrage Vite di serraggio	Tournevis TORX PLUS® Cacciavite TORX PLUS®
M310...	030.0324.T7P	T7PL

Fraise a tronçonner

Frese a disco a troncane



Fraise disque

Frese a disco

M310

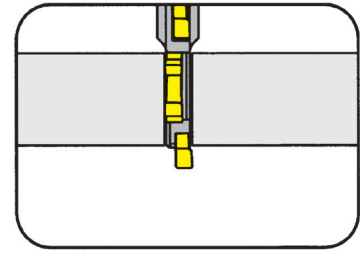

Profondeur de fraisage jusqu'à	Profondità di fresatura fino a	70 mm
Largeur de rainure	Larghezza della cava	4-5 mm
Diamètre de coupe	Diametro Ds	80-200 mm

Alésage (d2) rainure selon DIN 138
 Foro (d2) con chiavetta longitudinale secondo DIN 138

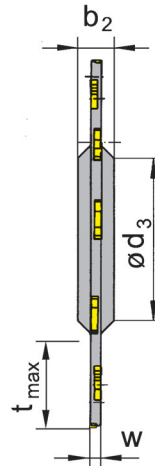
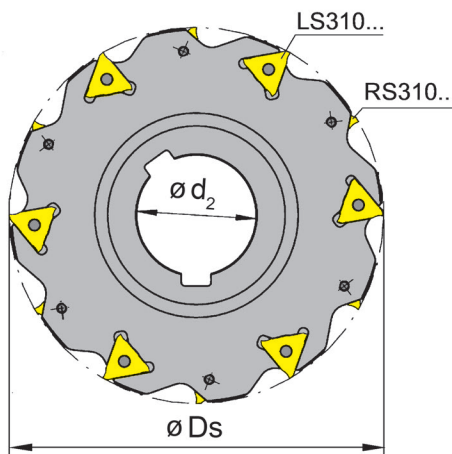

pour Plaquette amovible
 per Inserto

Type S310
 Tipo



Illustration de coupe à droite représentée
 Figura = taglio destro

N° de commande Codice prodotto	Z	Ds	t _{max}	d ₂	b ₂	w	Plaquette à droite Inserto destro	Plaquette à gauche Inserto sinistro
M310.0080.27.04	8	80	18	27	8	4	4x RS310.4023.00	4x LS310.4023.00
M310.0100.32.04	10	100	25	32	8	4	5x RS310.4023.00	S229.0300./0400...
M310.0125.40.04	12	125	32	40	10	4	6x RS310.4023.00	6x LS310.4023.00
M310.0160.40.04	16	160	50	40	10	4	8x RS310.4023.00	8x LS310.4023.00
M310.0200.40.04	20	200	70	40	10	4	10x RS310.4023.00	10x LS310.4023.00
M310.0080.27.05	8	80	18	27	8	5	4x RS310.5028.00	4x LS310.5028.00
M310.0100.32.05	10	100	25	32	8	5	5x RS310.5028.00	5x LS310.5028.00
M310.0125.40.05	12	125	32	40	10	5	6x RS310.5028.00	6x LS310.5028.00
M310.0160.40.05	16	160	50	40	10	5	8x RS310.5028.00	8x LS310.5028.00
M310.0200.40.05	20	200	70	40	10	5	10x RS310.5028.00	10x LS310.5028.00

Autres dimensions sur demande
 Dimensioni differenti sono fornibili su richiesta

Dimensions en mm
 Dimensioni in mm

Pour le couple de serrage des vis, merci de vous reporter aux Informations Techniques.
 Per il corretto serraggio dinamometrico del portainsero consultare le Informazioni Tecniche.

Pièces Détachées

Ricambi

Fraise disque Frese a disco	Vis de serrage Vite di serraggio	Tournevis TORX PLUS® Cacciavite TORX PLUS®
M310...04	030.3535.T8P	T8PL
M310...05	030.3543.T8P	T8PL

Fraise a tronçonner

Frese a disco a troncicare



Corps de fraise vissé

Fresa avvitabile

M310

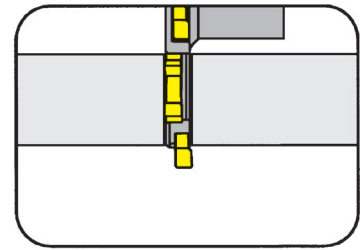

Profondeur de fraisage jusqu'à	Profondità di fresatura fino a	20 mm
Largeur de rainure	Larghezza della cava	3-5 mm
Diamètre de coupe	Diametro Ds	50-63 mm

pour Plaquette amovible
per Inserto

Type S310
Tipo

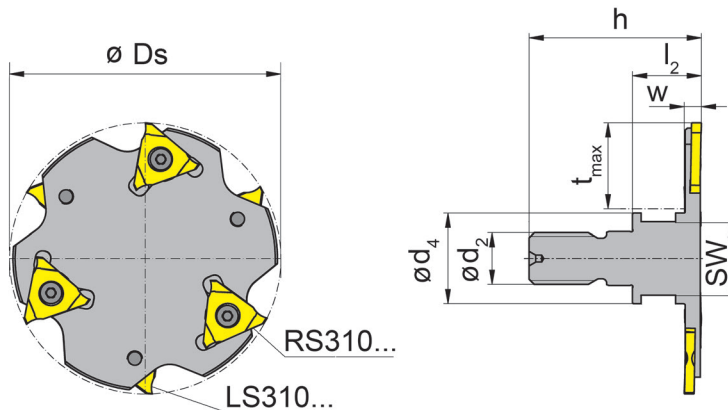

Illustration de coupe à droite représentée
Figura = taglio destro

N° de commande Codice prodotto	Z	Ds	h	l ₂	d ₂	d ₄	SW	w	t _{max}	Plaquette à droite Inserto destro	Plaquette à gauche Inserto sinistro
M310.0050.M10.03	6	50	33	13	M10	18	15	3	15	3x RS310.3017.00	3x LS310.3017.00
M310.0063.M12.03	6	63	39	15	M12	21	17	3	20	3x RS310.3017.00	3x LS310.3017.00
M310.0050.M10.04	6	50	34	14	M10	18	15	4	15	3x RS310.4023.00	3x LS310.4023.00
M310.0063.M12.04	6	63	40	16	M12	21	17	4	20	3x RS310.4023.00	3x LS310.4023.00
M310.0050.M10.05	6	50	35	15	M10	18	15	5	15	3x RS310.5028.00	3x LS310.5028.00
M310.0063.M12.05	6	63	41	17	M12	21	17	5	20	3x RS310.5028.00	3x LS310.5028.00

Autres dimensions sur demande
Dimensioni differenti sono fornibili su richiesta

Dimensions en mm
Dimensioni in mm

Pour le couple de serrage des vis, merci de vous reporter aux Informations Techniques.
Per il corretto serraggio dinamometrico del portainsero consultare le Informazioni Tecniche.

Pièces Détachées

Ricambi

Corps de fraise vissé Fresa avvitabile	Vis de serrage Vite di serraggio	Tournevis TORX PLUS® Cacciavite TORX PLUS®
M310...03	030.0324.T7P	T7PL
M310...04	030.3535.T8P	T8PL
M310...05	030.3543.T8P	T8PL

Fraise a tronçonner

Frese a disco a troncane



Fraise à moyeu

Fresa a manicotto

M310

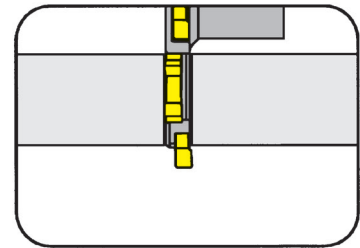

Profondeur de fraisage jusqu'à	Profondità di fresatura fino a	44 mm
Largeur de rainure	Larghezza della cava	3 mm
Diamètre de coupe	Diametro Ds	80-160 mm

Alésage (d2) rainure selon DIN 138
 Foro (d3) con chiavetta transversale secondo DIN 138

pour Plaquette amovible
 per Inserto

Type S310
 Tipo

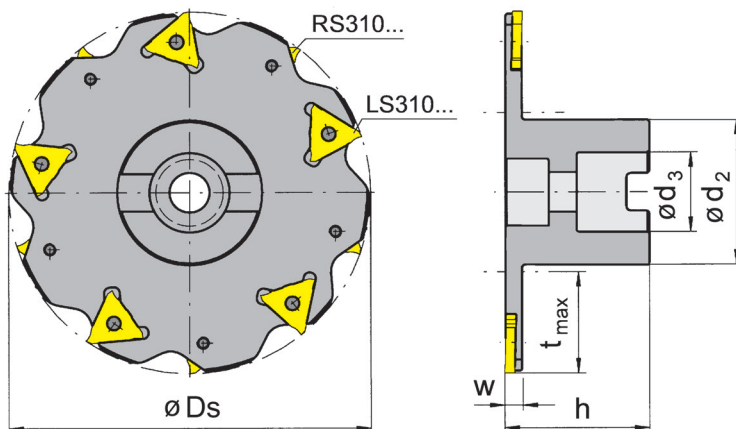

Illustration de coupe à droite représentée
 Figura = taglio destro

N° de commande Codice prodotto	Z	Ds	t _{max}	h	d ₂	d ₃	w	Plaquette à droite Inserto destro	Plaquette à gauche Inserto sinistro
M310.0080.22.03	8	80	23,0	40	33	27	3	4x RS310.3017.00	4x LS310.3017.00
M310.1100.27.03	10	100	25,0	50	48	27	3	5x RS310.3017.00	5x LS310.3017.00
M310.1125.27.03	12	125	35,7	50	48	27	3	6x RS310.3017.00	6x LS310.3017.00
M310.1125.32.03	12	125	32,5	50	58	32	3	6x RS310.3017.00	6x LS310.3017.00
M310.1125.40.03	12	125	26,5	50	70	40	3	6x RS310.3017.00	6x LS310.3017.00
M310.1160.40.03	16	160	44,0	50	70	40	3	8x RS310.3017.00	8x LS310.3017.00

Autres dimensions sur demande
 Dimensioni differenti sono fornibili su richiesta

Dimensions en mm
 Dimensioni in mm

Pour le couple de serrage des vis, merci de vous reporter aux Informations Techniques.
 Per il corretto serraggio dinamometrico del portainsero consultare le Informazioni Tecniche.

Pièces Détachées

Ricambi

Fraise à moyeu Fresa a manicotto	Clé allen Chiave e brugola	Vis de serrage Vite di serraggio	Tournevis TORX PLUS® Cacciavite TORX PLUS®
M310.0080.22.03	SW8,0 DIN 911	030.0324.T7P	T7PL
M310.1100.27.03	SW10,0 DIN 911	030.0324.T7P	T7PL
M310.1...		030.0324.T7P	T7PL

Fraise a tronçonner

Frese a disco a troncane



Fraise à moyeu

Fresa a manicotto

M310

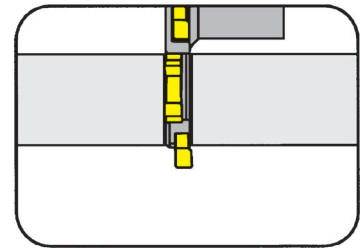

Profondeur de fraisage jusqu'à	Profondità di fresatura fino a	64 mm
Largeur de rainure	Larghezza della cava	4-5 mm
Diamètre de coupe	Diametro Ds	80-200 mm

Alésage (d2) rainure selon DIN 138
 Foro (d3) con chiavetta transversale secondo DIN 138

pour Plaquette amovible
 per Inserto

Type S310
 Tipo

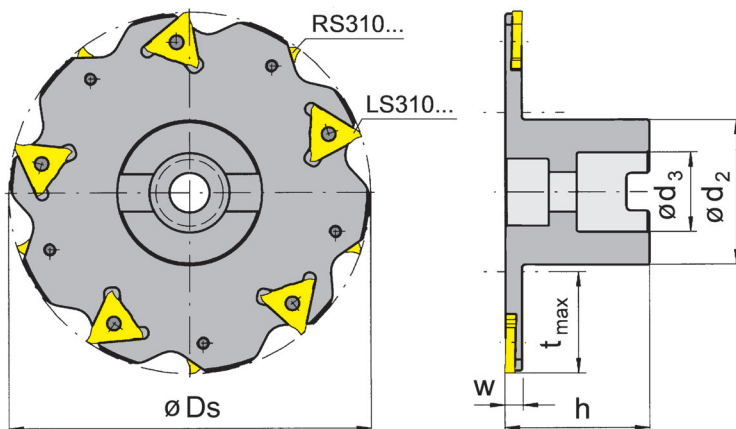

Illustration de coupe à droite représentée
 Figura = taglio destro

N° de commande Codice prodotto	Z	Ds	t _{max}	h	d ₂	d ₃	w	Plaquette à droite Inserto destro	Plaquette à gauche Inserto sinistro
M310.0080.22.04	8	80	23,0	40	33	22	4	4x RS310.4023.00	4x LS310.4023.00
M310.1100.27.04	10	100	25,0	50	48	27	4	5x RS310.4023.00	S229.0300./0400...
M310.1125.27.04	12	125	37,5	50	48	27	4	6x RS310.4023.00	6x LS310.4023.00
M310.1125.32.04	12	125	32,5	50	58	32	4	6x RS310.4023.00	6x LS310.4023.00
M310.1125.40.04	12	125	26,5	50	70	40	4	6x RS310.4023.00	6x LS310.4023.00
M310.1160.40.04	16	160	44,0	50	70	40	4	8x RS310.4023.00	8x LS310.4023.00
M310.1200.40.04	20	200	64,0	50	70	40	4	10x RS310.4023.00	10x LS310.4023.00
M310.0080.22.05	8	80	23,0	40	33	22	5	4x RS310.5028.00	4x LS310.5028.00
M310.1100.27.05	10	100	25,0	50	48	27	5	5x RS310.5028.00	5x LS310.5028.00
M310.1125.27.05	12	125	37,5	50	48	27	5	6x RS310.5028.00	6x LS310.5028.00
M310.1125.32.05	12	125	32,5	50	56	32	5	6x RS310.5028.00	6x LS310.5028.00
M310.1125.40.05	12	125	26,5	50	70	40	5	6x RS310.5028.00	6x LS310.5028.00
M310.1160.40.05	16	160	44,0	50	70	40	5	8x RS310.5028.00	8x LS310.5028.00
M310.1200.40.05	20	200	64,0	50	70	40	5	10x RS310.5028.00	10x LS310.5028.00

Autres dimensions sur demande
 Dimensioni differenti sono fornibili su richiesta

Dimensions en mm
 Dimensioni in mm

Pour le couple de serrage des vis, merci de vous reporter aux Informations Techniques.
 Per il corretto serraggio dinamometrico del portainsero consultare le Informazioni Tecniche.

Pièces Détachées

Ricambi

Fraise à moyeu Fresa a manicotto	Clé allen Chiave e brugola	Vis de serrage Vite di serraggio	Tournevis TORX PLUS® Cacciavite TORX PLUS®
M310.0080.22.04	SW8,0 DIN 911	030.3535.T8P	T8PL
M310...04		030.3535.T8P	T8PL
M310.0080.22.05	SW8,0 DIN 911	030.3543.T8P	T8PL
M310...27.05	SW10,0 DIN 911	030.3543.T8P	T8PL
M310...32.05/...40.05		030.3543.T8P	T8PL

Fraise a tronçonner

Frese a disco a troncicare



Plaquette amovible

Inserto

S310

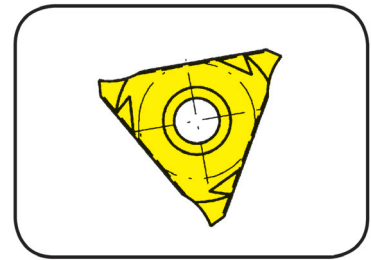

Largueur de gorge	Larghezza della gola	3-5 mm
-------------------	----------------------	--------

Fraise disque
Fresa a disco a troncicare

Type M310
Tipo

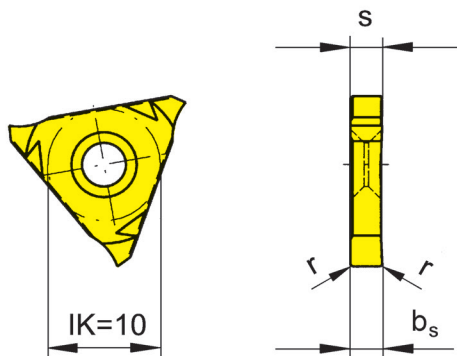

R = version à droite représentée
R = versione destra come in figura

L = version à gauche
L = versione sinistra a specchio

N° de commande Codice prodotto	w	r	b _s	s	AS45	TF45	TN35
					▲/▲	▲/▲	▲/▲
R/LS310.3017.00	3,000	0,15	1,7	1,6	▲/▲		
R/LS310.3118.00	3,175	0,15	1,8	1,6	▲/▲		
R/LS310.4023.00	4,000	0,20	2,3	2,2	▲/▲	▲/▲	▲/▲
R/LS310.5028.00	5,000	0,20	2,8	2,7	▲/▲	▲/▲	▲/▲

▲ en stock / a stock Δ 4 semaines / consegna 4 settimane x Sur demande / Su richiesta

● Premier choix / raccomandato

o Choix alternatif / alternativa

- ne convient pas / non adatto

■ Nuance non revêtue / non rivestito

■ Nuance revêtue / rivestito

■ brasé/Cermet / saldobrasato/Cermet

Dimensions en mm

Dimensioni in mm

Préciser R ou L version

Definire versione R o L

P	•	•	•
M	•	•	•
K	•	•	•
N	○	•	•
S	•	•	•
H	-	-	-

Nuance
Leghe

