

**Inserti per tornitura**

C

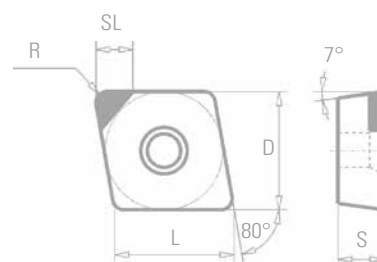

Codice ISO	Quota SL	HS 61	HS 33	HS 62	CI 02	Prezzo €
CCGW 060202	3,00	<input type="checkbox"/>	<input checked="" type="checkbox"/>	<input type="checkbox"/>	<input checked="" type="checkbox"/>	37,61
CCGW 060204	3,00	<input type="checkbox"/>	<input checked="" type="checkbox"/>	<input type="checkbox"/>	<input checked="" type="checkbox"/>	37,61
CCGW 060208	3,00	<input type="checkbox"/>	<input type="checkbox"/>	<input type="checkbox"/>	<input type="checkbox"/>	37,61
CCGW 080304	3,00	<input type="checkbox"/>	<input type="checkbox"/>	<input type="checkbox"/>	<input type="checkbox"/>	37,61
CCGW 080308	3,00	<input type="checkbox"/>	<input type="checkbox"/>	<input type="checkbox"/>	<input type="checkbox"/>	37,61
CCGW 090304	4,00	<input type="checkbox"/>	<input type="checkbox"/>	<input type="checkbox"/>	<input type="checkbox"/>	43,47
CCGW 090308	4,00	<input type="checkbox"/>	<input type="checkbox"/>	<input type="checkbox"/>	<input type="checkbox"/>	43,47
CCGW 09T302	4,00	<input type="checkbox"/>	<input type="checkbox"/>	<input type="checkbox"/>	<input type="checkbox"/>	43,47
CCGW 09T304	4,00	<input type="checkbox"/>	<input checked="" type="checkbox"/>	<input type="checkbox"/>	<input checked="" type="checkbox"/>	43,47
CCGW 09T308	4,00	<input type="checkbox"/>	<input checked="" type="checkbox"/>	<input type="checkbox"/>	<input checked="" type="checkbox"/>	43,47
CCGW 120402	4,00	<input type="checkbox"/>	<input type="checkbox"/>	<input type="checkbox"/>	<input type="checkbox"/>	43,47
CCGW 120404	4,00	<input type="checkbox"/>	<input checked="" type="checkbox"/>	<input type="checkbox"/>	<input checked="" type="checkbox"/>	43,47
CCGW 120408	4,00	<input type="checkbox"/>	<input checked="" type="checkbox"/>	<input type="checkbox"/>	<input checked="" type="checkbox"/>	43,47
CCGW 120412	4,00	<input type="checkbox"/>	<input type="checkbox"/>	<input type="checkbox"/>	<input type="checkbox"/>	43,47



Geometria Wiper destra e sinistra	Quota SL	HS 61	HS 33	HS 62	CI 02	Prezzo €
W-CCGW 09T302	4,00	<input type="checkbox"/>	<input type="checkbox"/>	<input type="checkbox"/>	<input type="checkbox"/>	47,50
W-CCGW 09T304	4,00	<input type="checkbox"/>	<input type="checkbox"/>	<input type="checkbox"/>	<input type="checkbox"/>	47,50
W-CCGW 09T308	4,00	<input type="checkbox"/>	<input type="checkbox"/>	<input type="checkbox"/>	<input type="checkbox"/>	47,50



Esecuzione destra

L-CCGW 060202 R	6,40	<input type="checkbox"/>	<input type="checkbox"/>	<input type="checkbox"/>	<input type="checkbox"/>	60,38
L-CCGW 060204 R	6,40	<input type="checkbox"/>	<input type="checkbox"/>	<input type="checkbox"/>	<input type="checkbox"/>	60,38
L-CCGW 09T302 R	9,70	<input type="checkbox"/>	<input type="checkbox"/>	<input type="checkbox"/>	<input type="checkbox"/>	68,89
L-CCGW 09T304 R	9,70	<input type="checkbox"/>	<input type="checkbox"/>	<input type="checkbox"/>	<input type="checkbox"/>	68,89
L-CCGW 09T308 R	9,70	<input type="checkbox"/>	<input type="checkbox"/>	<input type="checkbox"/>	<input type="checkbox"/>	68,89
L-CCGW 120404 R	12,90	<input type="checkbox"/>	<input type="checkbox"/>	<input type="checkbox"/>	<input type="checkbox"/>	88,55
L-CCGW 120408 R	12,90	<input type="checkbox"/>	<input type="checkbox"/>	<input type="checkbox"/>	<input type="checkbox"/>	88,55

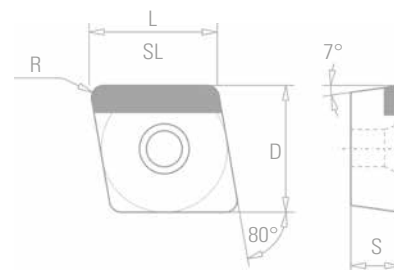

Esecuzione sinistra

L-CCGW 060202 L	6,40	<input type="checkbox"/>	<input type="checkbox"/>	<input type="checkbox"/>	<input type="checkbox"/>	60,38
L-CCGW 060204 L	6,40	<input type="checkbox"/>	<input type="checkbox"/>	<input type="checkbox"/>	<input type="checkbox"/>	60,38
L-CCGW 09T302 L	9,70	<input type="checkbox"/>	<input type="checkbox"/>	<input type="checkbox"/>	<input type="checkbox"/>	68,89
L-CCGW 09T304 L	9,70	<input type="checkbox"/>	<input type="checkbox"/>	<input type="checkbox"/>	<input type="checkbox"/>	68,89
L-CCGW 09T308 L	9,70	<input type="checkbox"/>	<input type="checkbox"/>	<input type="checkbox"/>	<input type="checkbox"/>	68,89
L-CCGW 120404 L	12,90	<input type="checkbox"/>	<input type="checkbox"/>	<input type="checkbox"/>	<input type="checkbox"/>	88,55
L-CCGW 120408 L	12,90	<input type="checkbox"/>	<input type="checkbox"/>	<input type="checkbox"/>	<input type="checkbox"/>	88,55

Esempio d'ordine: CCGW 120404 HS33

N.B. Prezzo cad. per 5 pz. e più. Ordinativo minimo 3 pz. Per 3 e 4 pezzi considerare maggiorazione +10%

Vedi la descrizione delle leghe a pagina 6

■ -disponibile a stock

□ -disponibile in breve tempo su richiesta

**Inserti per tornitura**

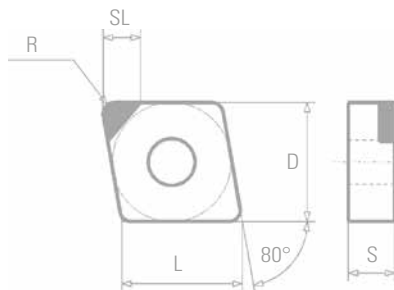

Codice ISO	Quota SL	HS 61	HS 33	HS 62	CI 02	Prezzo €
CNGA 120401	4,00	<input type="checkbox"/>	<input checked="" type="checkbox"/>	<input type="checkbox"/>	<input type="checkbox"/>	43,47
CNGA 120402	4,00	<input type="checkbox"/>	<input checked="" type="checkbox"/>	<input type="checkbox"/>	<input checked="" type="checkbox"/>	43,47
CNGA 120403	4,00	<input type="checkbox"/>	<input type="checkbox"/>	<input type="checkbox"/>	<input type="checkbox"/>	43,47
CNGA 120404	4,00	<input type="checkbox"/>	<input checked="" type="checkbox"/>	<input type="checkbox"/>	<input checked="" type="checkbox"/>	43,47
CNGA 120406	4,00	<input type="checkbox"/>	<input type="checkbox"/>	<input type="checkbox"/>	<input type="checkbox"/>	43,47
CNGA 120408	4,00	<input type="checkbox"/>	<input checked="" type="checkbox"/>	<input type="checkbox"/>	<input checked="" type="checkbox"/>	43,47
CNGA 120410	4,00	<input type="checkbox"/>	<input checked="" type="checkbox"/>	<input type="checkbox"/>	<input type="checkbox"/>	43,47
CNGA 120412	4,00	<input type="checkbox"/>	<input checked="" type="checkbox"/>	<input type="checkbox"/>	<input checked="" type="checkbox"/>	43,47
CNGA 120416	4,00	<input type="checkbox"/>	<input type="checkbox"/>	<input type="checkbox"/>	<input type="checkbox"/>	43,47

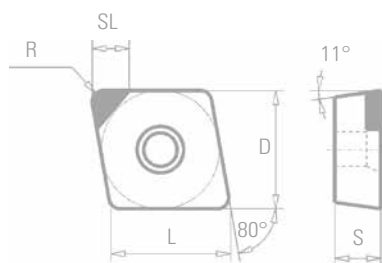

CPGW 05T102	3,00	<input type="checkbox"/>	<input type="checkbox"/>	<input type="checkbox"/>	<input type="checkbox"/>	37,61
CPGW 05T104	3,00	<input type="checkbox"/>	<input checked="" type="checkbox"/>	<input type="checkbox"/>	<input type="checkbox"/>	37,61
CPGW 060202	3,00	<input type="checkbox"/>	<input checked="" type="checkbox"/>	<input type="checkbox"/>	<input checked="" type="checkbox"/>	37,61
CPGW 060204	3,00	<input type="checkbox"/>	<input checked="" type="checkbox"/>	<input type="checkbox"/>	<input checked="" type="checkbox"/>	37,61
CPGW 090304	4,00	<input type="checkbox"/>	<input type="checkbox"/>	<input type="checkbox"/>	<input type="checkbox"/>	43,47
CPGW 090308	4,00	<input type="checkbox"/>	<input type="checkbox"/>	<input type="checkbox"/>	<input type="checkbox"/>	43,47
CPGW 09T304	4,00	<input type="checkbox"/>	<input checked="" type="checkbox"/>	<input type="checkbox"/>	<input checked="" type="checkbox"/>	43,47
CPGW 09T308	4,00	<input type="checkbox"/>	<input checked="" type="checkbox"/>	<input type="checkbox"/>	<input checked="" type="checkbox"/>	43,47
CPGW 120404	4,00	<input type="checkbox"/>	<input type="checkbox"/>	<input type="checkbox"/>	<input type="checkbox"/>	43,47
CPGW 120408	4,00	<input type="checkbox"/>	<input type="checkbox"/>	<input type="checkbox"/>	<input type="checkbox"/>	43,47

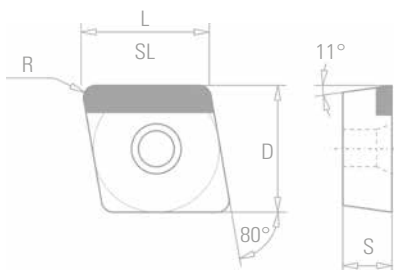

L CPGW 060202 R	6,40	<input type="checkbox"/>	<input type="checkbox"/>	<input type="checkbox"/>	<input type="checkbox"/>	60,38
L CPGW 060204 R	6,40	<input type="checkbox"/>	<input checked="" type="checkbox"/>	<input type="checkbox"/>	<input type="checkbox"/>	60,38
L CPGW 09T302 R	9,70	<input type="checkbox"/>	<input type="checkbox"/>	<input type="checkbox"/>	<input type="checkbox"/>	68,89
L CPGW 09T304 R	9,70	<input type="checkbox"/>	<input type="checkbox"/>	<input type="checkbox"/>	<input type="checkbox"/>	68,89
L CPGW 120404 R	12,90	<input type="checkbox"/>	<input type="checkbox"/>	<input type="checkbox"/>	<input type="checkbox"/>	88,55
L CPGW 120408 R	12,90	<input type="checkbox"/>	<input type="checkbox"/>	<input type="checkbox"/>	<input type="checkbox"/>	88,55



Esecuzione destra

L CPGW 060202 L	6,40	<input type="checkbox"/>	<input type="checkbox"/>	<input type="checkbox"/>	<input type="checkbox"/>	60,38
L CPGW 060204 L	6,40	<input type="checkbox"/>	<input checked="" type="checkbox"/>	<input type="checkbox"/>	<input type="checkbox"/>	60,38
L CPGW 09T302 L	9,70	<input type="checkbox"/>	<input type="checkbox"/>	<input type="checkbox"/>	<input type="checkbox"/>	68,89
L CPGW 09T304 L	9,70	<input type="checkbox"/>	<input type="checkbox"/>	<input type="checkbox"/>	<input type="checkbox"/>	68,89
L CPGW 120404 L	12,90	<input type="checkbox"/>	<input type="checkbox"/>	<input type="checkbox"/>	<input type="checkbox"/>	88,55
L CPGW 120408 L	12,90	<input type="checkbox"/>	<input type="checkbox"/>	<input type="checkbox"/>	<input type="checkbox"/>	88,55



Esecuzione sinistra

Esempio d'ordine: CCGW 120404 HS33

N.B. Prezzo cad. per 5 pz. e più. Ordinativo minimo 3 pz. Per 3 e 4 pezzi considerare maggiorazione +10%

Vedi la descrizione delle leghe a pagina 6

- disponibile a stock
- disponibile in breve tempo su richiesta

**Inserti per tornitura**

**D**



Codice ISO	Quota SL	HS 61	HS 33	HS 62	CI 02	Prezzo €
DCGW 070202	3,00	☐	■	☐	■	37,61
DCGW 070204	3,00	☐	■	☐	■	37,61
DCGW 070208	3,00	☐	■	☐	■	37,61
DCGW 11T302	4,00	☐	■	☐	■	43,47
DCGW 11T304	4,00	☐	■	☐	■	43,47
DCGW 11T308	4,00	☐	■	☐	■	43,47
DCGW 150404	4,00	☐	☐	☐	☐	43,47
DCGW 150408	4,00	☐	☐	☐	☐	43,47

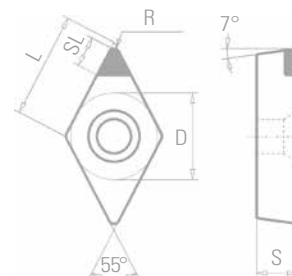

DNGA 150404	4,00	☐	■	☐	☐	43,47
DNGA 150408	4,00	☐	■	☐	☐	43,47
DNGA 150412	4,00	☐	■	☐	■	43,47
DNGA 150604	4,00	☐	■	☐	■	43,47
DNGA 150608	4,00	☐	■	☐	■	43,47
DNGA 150612	4,00	☐	☐	☐	☐	43,47

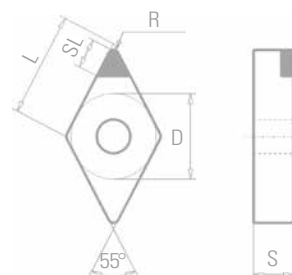

DPGW 070202	3,00	☐	☐	☐	☐	37,61
DPGW 070204	3,00	☐	☐	☐	☐	37,61
DPGW 070208	3,00	☐	☐	☐	☐	37,61
DPGW 11T302	4,00	☐	☐	☐	☐	43,47
DPGW 11T304	4,00	☐	☐	☐	■	43,47
DPGW 11T308	4,00	☐	■	☐	☐	43,47

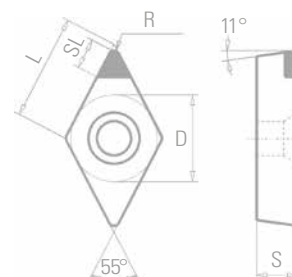

**E**



Codice ISO	Quota SL	HS 61	HS 33	HS 62	CI 02	Prezzo €
ECGW 09T304	4,00	☐	☐	☐	☐	44,74
ECGW 09T308	4,00	☐	☐	☐	☐	44,74
ECGW 12T304	4,00	☐	☐	☐	☐	44,74
ECGW 12T308	4,00	☐	☐	☐	■	44,74

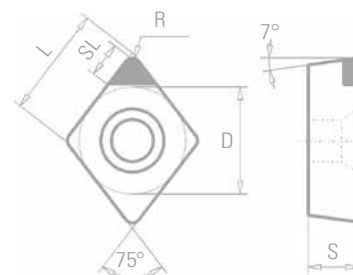

EPGW 040202	2,60	☐	☐	☐	☐	43,47
EPGW 040204	2,60	☐	☐	☐	☐	43,47
EPGW 060202	3,00	☐	☐	☐	☐	43,47
EPGW 060204	3,00	☐	☐	☐	☐	43,47
EPGW 080302	4,00	☐	☐	☐	☐	44,74
EPGW 080304	4,00	☐	☐	☐	☐	44,74
EPGW 080308	4,00	☐	☐	☐	☐	44,74

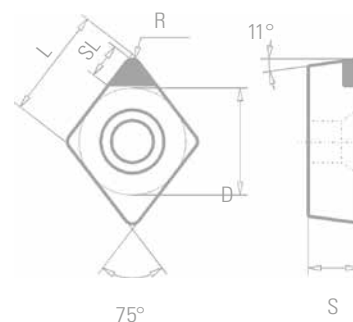

Esempio d'ordine: CCGW 120404 HS33

N.B. Prezzo cad. per 5 pz. e più. Ordinativo minimo 3 pz. Per 3 e 4 pezzi considerare maggiorazione +10%

Vedi la descrizione delle leghe a pagina 6

■ -disponibile a stock

☐ -disponibile in breve tempo su richiesta

**Inserti per tornitura**

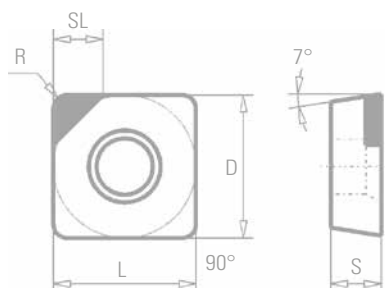

Codice ISO	Quota SL	HS 61	HS 33	HS 62	CI 02	Prezzo €
SCGW 060202	3,00	<input type="checkbox"/>	<input type="checkbox"/>	<input type="checkbox"/>	<input type="checkbox"/>	37,61
SCGW 060204	3,00	<input type="checkbox"/>	<input type="checkbox"/>	<input type="checkbox"/>	<input type="checkbox"/>	37,61
SCGW 090302	4,00	<input type="checkbox"/>	<input type="checkbox"/>	<input type="checkbox"/>	<input type="checkbox"/>	43,47
SCGW 090304	4,00	<input type="checkbox"/>	<input type="checkbox"/>	<input type="checkbox"/>	<input type="checkbox"/>	43,47
SCGW 090308	4,00	<input type="checkbox"/>	<input type="checkbox"/>	<input type="checkbox"/>	<input type="checkbox"/>	43,47
SCGW 09T302	4,00	<input type="checkbox"/>	<input checked="" type="checkbox"/>	<input type="checkbox"/>	<input checked="" type="checkbox"/>	43,47
SCGW 09T304	4,00	<input type="checkbox"/>	<input checked="" type="checkbox"/>	<input type="checkbox"/>	<input checked="" type="checkbox"/>	43,47
SCGW 09T308	4,00	<input type="checkbox"/>	<input checked="" type="checkbox"/>	<input type="checkbox"/>	<input checked="" type="checkbox"/>	43,47
SCGW 120404	4,00	<input type="checkbox"/>	<input checked="" type="checkbox"/>	<input type="checkbox"/>	<input checked="" type="checkbox"/>	43,47
SCGW 120408	4,00	<input type="checkbox"/>	<input checked="" type="checkbox"/>	<input type="checkbox"/>	<input checked="" type="checkbox"/>	43,47

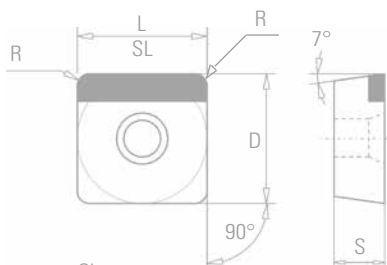

L SCGW 060202	6,35	<input type="checkbox"/>	<input type="checkbox"/>	<input type="checkbox"/>	<input type="checkbox"/>	60,38
L SCGW 060204	6,35	<input type="checkbox"/>	<input type="checkbox"/>	<input type="checkbox"/>	<input type="checkbox"/>	60,38
L SCGW 09T302	9,52	<input type="checkbox"/>	<input type="checkbox"/>	<input type="checkbox"/>	<input type="checkbox"/>	68,89
L SCGW 09T304	9,52	<input type="checkbox"/>	<input type="checkbox"/>	<input type="checkbox"/>	<input type="checkbox"/>	68,89
L SCGW 09T308	9,52	<input type="checkbox"/>	<input type="checkbox"/>	<input type="checkbox"/>	<input type="checkbox"/>	68,89
L SCGW 120404	12,70	<input type="checkbox"/>	<input type="checkbox"/>	<input type="checkbox"/>	<input type="checkbox"/>	88,55
L SCGW 120408	12,70	<input type="checkbox"/>	<input type="checkbox"/>	<input type="checkbox"/>	<input type="checkbox"/>	88,55

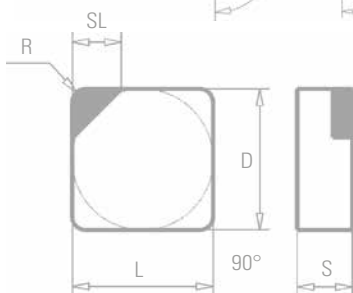

SNGN 090304	4,00	<input type="checkbox"/>	<input type="checkbox"/>	<input type="checkbox"/>	<input type="checkbox"/>	43,47
SNGN 090308	4,00	<input type="checkbox"/>	<input type="checkbox"/>	<input type="checkbox"/>	<input type="checkbox"/>	43,47
SNGN 120304	4,00	<input type="checkbox"/>	<input type="checkbox"/>	<input type="checkbox"/>	<input type="checkbox"/>	43,47
SNGN 120308	4,00	<input type="checkbox"/>	<input type="checkbox"/>	<input type="checkbox"/>	<input type="checkbox"/>	43,47
SNGN 120404	4,00	<input type="checkbox"/>	<input type="checkbox"/>	<input type="checkbox"/>	<input type="checkbox"/>	43,47
SNGN 120408	4,00	<input type="checkbox"/>	<input type="checkbox"/>	<input type="checkbox"/>	<input type="checkbox"/>	43,47

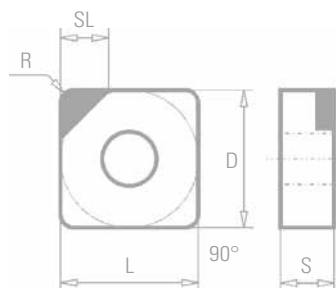

SNGA 090304	4,00	<input type="checkbox"/>	<input type="checkbox"/>	<input type="checkbox"/>	<input type="checkbox"/>	43,47
SNGA 090308	4,00	<input type="checkbox"/>	<input type="checkbox"/>	<input type="checkbox"/>	<input type="checkbox"/>	43,47
SNGA 120404	4,00	<input type="checkbox"/>	<input checked="" type="checkbox"/>	<input type="checkbox"/>	<input checked="" type="checkbox"/>	43,47
SNGA 120408	4,00	<input type="checkbox"/>	<input checked="" type="checkbox"/>	<input type="checkbox"/>	<input checked="" type="checkbox"/>	43,47

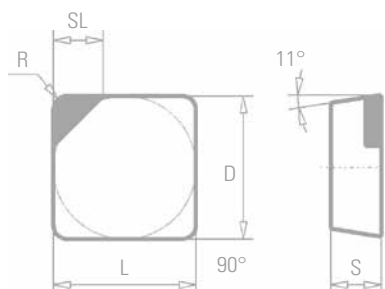

SPGN 070202	3,00	<input type="checkbox"/>	<input type="checkbox"/>	<input type="checkbox"/>	<input type="checkbox"/>	43,47
SPGN 070204	3,00	<input type="checkbox"/>	<input type="checkbox"/>	<input type="checkbox"/>	<input type="checkbox"/>	43,47
SPGN 090302	4,00	<input type="checkbox"/>	<input type="checkbox"/>	<input type="checkbox"/>	<input type="checkbox"/>	43,47
SPGN 090304	4,00	<input type="checkbox"/>	<input type="checkbox"/>	<input type="checkbox"/>	<input type="checkbox"/>	43,47
SPGN 120304	4,00	<input type="checkbox"/>	<input type="checkbox"/>	<input type="checkbox"/>	<input type="checkbox"/>	43,47
SPGN 120308	4,00	<input type="checkbox"/>	<input type="checkbox"/>	<input type="checkbox"/>	<input type="checkbox"/>	43,47
SPGN 120404	4,00	<input type="checkbox"/>	<input type="checkbox"/>	<input type="checkbox"/>	<input type="checkbox"/>	43,47
SPGN 120408	4,00	<input type="checkbox"/>	<input type="checkbox"/>	<input type="checkbox"/>	<input type="checkbox"/>	43,47



Esempio d'ordine: CCGW 120404 HS33

N.B. Prezzo cad. per 5 pz. e più. Ordinativo minimo 3 pz. Per 3 e 4 pezzi considerare maggiorazione +10%

Vedi la descrizione delle leghe a pagina 6

- disponibile a stock
- disponibile in breve tempo su richiesta

**Inserti per tornitura**

S



Codice ISO	Quota SL	HS 61	HS 33	HS 62	CI 02	Prezzo €
SPGW 070302	3,00	☐	☐	☐	☐	43,47
SPGW 070304	3,00	☐	☐	☐	☐	43,47
SPGW 090302	4,00	☐	☐	☐	☐	43,47
SPGW 090304	4,00	☐	☐	☐	☐	43,47
SPGW 090308	4,00	☐	☐	☐	☐	43,47
SPGW 09T302	4,00	☐	☐	☐	☐	43,47
SPGW 09T304	4,00	☐	☐	☐	☐	43,47
SPGW 09T308	4,00	☐	☐	☐	☐	43,47
SPGW 120402	4,00	☐	☐	☐	☐	43,47
SPGW 120404	4,00	☐	☐	☐	☐	43,47
SPGW 120408	4,00	☐	☐	☐	☐	43,47

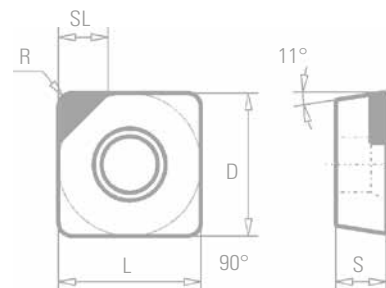

T



Codice ISO	Quota SL	HS 61	HS 33	HS 62	CI 02	Prezzo €
TCGW 090202	3,00	☐	☐	☐	☐	37,61
TCGW 090204	3,00	☐	☐	☐	☐	37,61
TCGW 090208	3,00	☐	☐	☐	☐	37,61
TCGW 110202	4,00	☐	☐	☐	☐	43,47
TCGW 110204	4,00	☐	☐	☐	☐	43,47
TCGW 110208	4,00	☐	☐	☐	☐	43,47
TCGW 130404	4,00	☐	☐	☐	☐	43,47
TCGW 130408	4,00	☐	☐	☐	☐	43,47
TCGW 16T302	4,00	☐	☐	☐	☐	43,47
TCGW 16T304	4,00	☐	■	☐	■	43,47
TCGW 16T308	4,00	☐	■	☐	■	43,47
TCGW 16T312	4,00	☐	☐	☐	☐	43,47

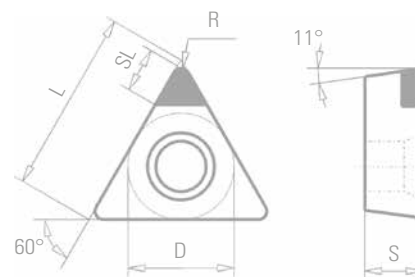

L-TCGW 090202	9,34	☐	☐	☐	☐	71,30
L-TCGW 090204	9,04	☐	☐	☐	☐	71,30
L-TCGW 110202	10,71	☐	☐	☐	☐	75,90
L-TCGW 110204	10,41	☐	☐	☐	☐	75,90
L-TCGW 110208	9,93	☐	☐	☐	☐	75,90
L-TCGW 16T302	16,20	☐	☐	☐	☐	94,30
L-TCGW 16T304	15,91	☐	☐	☐	☐	94,30
L-TCGW 16T308	15,33	☐	☐	☐	☐	94,30

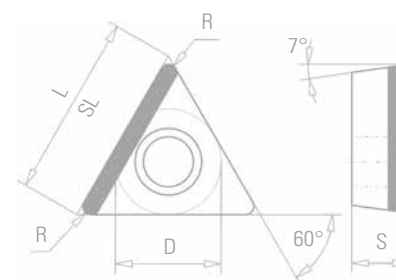

TNGN 110304	4,00	☐	☐	☐	☐	43,47
TNGN 110308	4,00	☐	☐	☐	☐	43,47
TNGN 130304	4,00	☐	☐	☐	☐	43,47
TNGN 130308	4,00	☐	☐	☐	☐	43,47
TNGN 160304	4,00	☐	☐	☐	☐	43,47
TNGN 160308	4,00	☐	☐	☐	☐	43,47
TNGN 160404	4,00	☐	☐	☐	☐	43,47
TNGN 160408	4,00	☐	☐	☐	☐	43,47

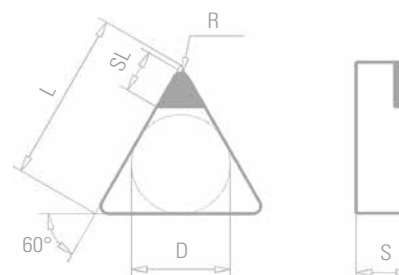

Esempio d'ordine: CCGW 120404 HS33

N.B. Prezzo cad. per 5 pz. e più. Ordinativo minimo 3 pz. Per 3 e 4 pezzi considerare maggiorazione +10%

Vedi la descrizione delle leghe a pagina 6

■ -disponibile a stock

☐ -disponibile in breve tempo su richiesta

**Inserti per tornitura**

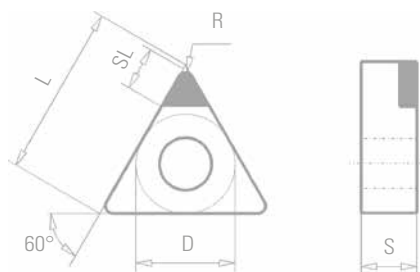

Codice ISO	Quota SL	HS 61	HS 33	HS 62	CI 02	Prezzo €
TNGA 110304	4,00	<input type="checkbox"/>	<input type="checkbox"/>	<input type="checkbox"/>	<input type="checkbox"/>	43,47
TNGA 110308	4,00	<input type="checkbox"/>	<input type="checkbox"/>	<input type="checkbox"/>	<input type="checkbox"/>	43,47
TNGA 160304	4,00	<input type="checkbox"/>	<input type="checkbox"/>	<input type="checkbox"/>	<input type="checkbox"/>	43,47
TNGA 160308	4,00	<input type="checkbox"/>	<input type="checkbox"/>	<input type="checkbox"/>	<input type="checkbox"/>	43,47
TNGA 160403	4,00	<input type="checkbox"/>	<input checked="" type="checkbox"/>	<input type="checkbox"/>	<input type="checkbox"/>	43,47
TNGA 160404	4,00	<input type="checkbox"/>	<input checked="" type="checkbox"/>	<input type="checkbox"/>	<input checked="" type="checkbox"/>	43,47
TNGA 160408	4,00	<input type="checkbox"/>	<input checked="" type="checkbox"/>	<input type="checkbox"/>	<input checked="" type="checkbox"/>	43,47
TNGA 160410	4,00	<input type="checkbox"/>	<input checked="" type="checkbox"/>	<input type="checkbox"/>	<input type="checkbox"/>	43,47
TNGA 160412	4,00	<input type="checkbox"/>	<input type="checkbox"/>	<input type="checkbox"/>	<input type="checkbox"/>	43,47
TNGA 220404	4,00	<input type="checkbox"/>	<input type="checkbox"/>	<input type="checkbox"/>	<input type="checkbox"/>	43,47
TNGA 220408	4,00	<input type="checkbox"/>	<input type="checkbox"/>	<input type="checkbox"/>	<input type="checkbox"/>	43,47

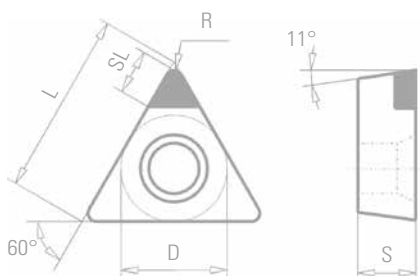

TPGW 110202	4,00	<input type="checkbox"/>	<input type="checkbox"/>	<input type="checkbox"/>	<input type="checkbox"/>	43,47
TPGW 110204	4,00	<input type="checkbox"/>	<input type="checkbox"/>	<input type="checkbox"/>	<input type="checkbox"/>	43,47
TPGW 110208	4,00	<input type="checkbox"/>	<input type="checkbox"/>	<input type="checkbox"/>	<input type="checkbox"/>	43,47
TPGW 110302	4,00	<input type="checkbox"/>	<input type="checkbox"/>	<input type="checkbox"/>	<input type="checkbox"/>	43,47
TPGW 110304	4,00	<input type="checkbox"/>	<input type="checkbox"/>	<input type="checkbox"/>	<input type="checkbox"/>	43,47
TPGW 110308	4,00	<input type="checkbox"/>	<input type="checkbox"/>	<input type="checkbox"/>	<input type="checkbox"/>	43,47
TPGW 16T304	4,00	<input type="checkbox"/>	<input type="checkbox"/>	<input type="checkbox"/>	<input type="checkbox"/>	43,47
TPGW 16T308	4,00	<input type="checkbox"/>	<input type="checkbox"/>	<input type="checkbox"/>	<input type="checkbox"/>	43,47
TPGW 160404	4,00	<input type="checkbox"/>	<input type="checkbox"/>	<input type="checkbox"/>	<input type="checkbox"/>	43,47
TPGW 160408	4,00	<input type="checkbox"/>	<input type="checkbox"/>	<input type="checkbox"/>	<input type="checkbox"/>	43,47

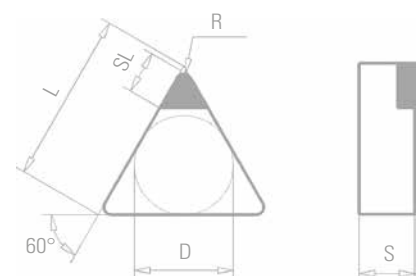

TPGN 090202	3,00	<input type="checkbox"/>	<input type="checkbox"/>	<input type="checkbox"/>	<input type="checkbox"/>	37,61
TPGN 090204	3,00	<input type="checkbox"/>	<input type="checkbox"/>	<input type="checkbox"/>	<input type="checkbox"/>	37,61
TPGN 090208	3,00	<input type="checkbox"/>	<input type="checkbox"/>	<input type="checkbox"/>	<input type="checkbox"/>	37,61
TPGN 110202	4,00	<input type="checkbox"/>	<input type="checkbox"/>	<input type="checkbox"/>	<input type="checkbox"/>	43,47
TPGN 110204	4,00	<input type="checkbox"/>	<input type="checkbox"/>	<input type="checkbox"/>	<input checked="" type="checkbox"/>	43,47
TPGN 110208	4,00	<input type="checkbox"/>	<input type="checkbox"/>	<input type="checkbox"/>	<input type="checkbox"/>	43,47
TPGN 110302	4,00	<input type="checkbox"/>	<input type="checkbox"/>	<input type="checkbox"/>	<input type="checkbox"/>	43,47
TPGN 110304	4,00	<input type="checkbox"/>	<input type="checkbox"/>	<input type="checkbox"/>	<input checked="" type="checkbox"/>	43,47
TPGN 110308	4,00	<input type="checkbox"/>	<input type="checkbox"/>	<input type="checkbox"/>	<input checked="" type="checkbox"/>	43,47
TPGN 160304	4,00	<input type="checkbox"/>	<input checked="" type="checkbox"/>	<input type="checkbox"/>	<input checked="" type="checkbox"/>	43,47
TPGN 160308	4,00	<input type="checkbox"/>	<input checked="" type="checkbox"/>	<input type="checkbox"/>	<input type="checkbox"/>	43,47



Esempio d'ordine: CCGW 120404 HS33

N.B. Prezzo cad. per 5 pz. e più. Ordinativo minimo 3 pz. Per 3 e 4 pezzi considerare maggiorazione +10%

Vedi la descrizione delle leghe a pagina 6

- disponibile a stock
- disponibile in breve tempo su richiesta



**Inserti per tornitura**

V



Codice ISO	Quota SL	HS 61	HS 33	HS 62	CI 02	Prezzo €
VBGW 110201	3,70	☐	☐	☐	☐	37,61
VBGW 110202	3,70	☐	☐	☐	☐	37,61
VBGW 110204	3,70	☐	☐	☐	☐	37,61
VBGW 110302	3,70	☐	☐	☐	☐	37,61
VBGW 110304	3,70	☐	☐	☐	☐	37,61
VBGW 110308	3,70	☐	☐	☐	☐	37,61
VBGW 160402	4,50	☐	☐	☐	☐	44,74
VBGW 160404	4,50	☐	■	☐	■	44,74
VBGW 160406	4,50	☐	☐	☐	☐	44,74
VBGW 160408	4,50	☐	■	☐	■	44,74
VBGW 160412	4,50	☐	☐	☐	☐	44,74

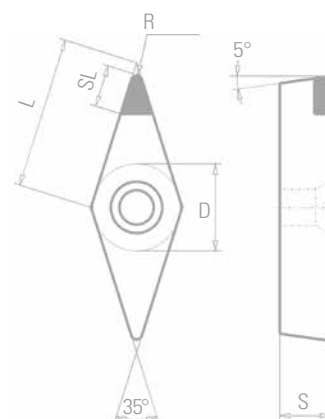

VCGW 070202	3,70	☐	☐	☐	☐	37,61
VCGW 070204	3,70	☐	☐	☐	☐	37,61
VCGW 070208	3,70	☐	☐	☐	☐	37,61
VCGW 110302	3,70	☐	■	☐	☐	37,61
VCGW 110304	3,70	☐	■	☐	☐	37,61
VCGW 110308	3,70	☐	☐	☐	☐	37,61
VCGW 130302	3,70	☐	☐	☐	☐	44,74
VCGW 130304	3,70	☐	☐	☐	☐	44,74
VCGW 160402	4,50	☐	☐	☐	☐	44,74
VCGW 160404	4,50	☐	■	☐	☐	44,74
VCGW 160408	4,50	☐	■	☐	☐	44,74
VCGW 160412	4,50	☐	☐	☐	☐	44,74

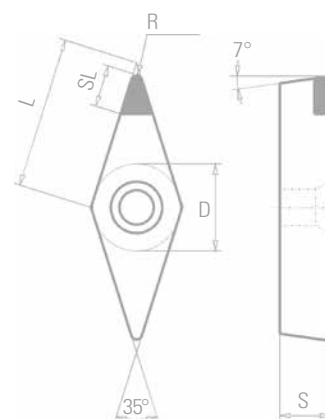

VNGA 160402	4,50	☐	■	☐	☐	44,74
VNGA 160403	4,50	☐	☐	☐	☐	44,74
VNGA 160404	4,50	☐	■	☐	■	44,74
VNGA 160406	4,50	☐	☐	☐	☐	44,74
VNGA 160408	4,50	☐	■	☐	■	44,74
VNGA 160410	4,50	☐	☐	☐	☐	44,74
VNGA 160412	4,50	☐	■	☐	☐	44,74

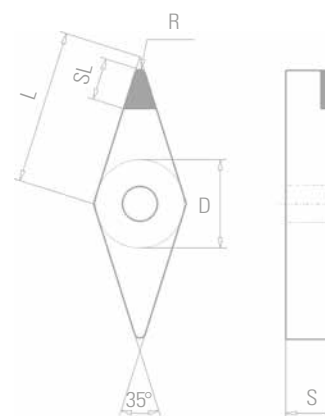

W



Codice ISO	Quota SL	HS 61	HS 33	HS 62	CI 02	Prezzo €
WNGA 080404	4,00	☐	☐	☐	☐	43,47
WNGA 080408	4,00	☐	☐	☐	☐	43,47
WNGA 080412	4,00	☐	☐	☐	☐	43,47

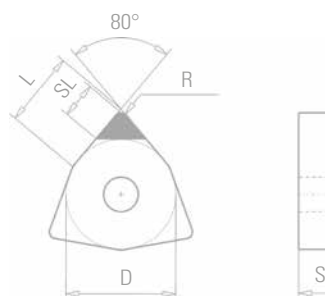

Esempio d'ordine: CCGW 120404 HS33

N.B. Prezzo cad. per 5 pz. e più. Ordinativo minimo 3 pz. Per 3 e 4 pezzi considerare maggiorazione +10%

Vedi la descrizione delle leghe a pagina 6

■ -disponibile a stock

☐ -disponibile in breve tempo su richiesta

**Inserti per tornitura con mini riporto**

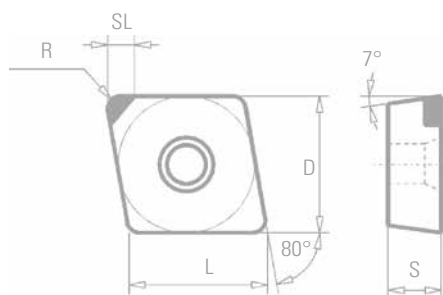

Codice ISO	Quota SL	HS 61	HS 33	HS 62	CI 02	Prezzo €
E-CCGW 060202	2,70	☐	☐	☐	☐	29,79
E-CCGW 060204	2,70	☐	☐	☐	☐	29,79
E-CCGW 09T302	2,70	☐	☐	☐	☐	29,79
E-CCGW 09T304	2,70	☐	■	☐	■	29,79
E-CCGW 09T308	2,70	☐	■	☐	■	29,79
E-CCGW 120402	2,70	☐	☐	☐	☐	29,79
E-CCGW 120404	2,70	☐	■	☐	■	29,79
E-CCGW 120408	2,70	☐	■	☐	☐	29,79

Geometria Wiper destra e sinistra					
EW-CCGW 060202	2,70		☐		33,81
EW-CCGW 060204	2,70		☐		33,81
EW-CCGW 09T304	2,70		☐		33,81
EW-CCGW 09T308	2,70		☐		33,81

D-CCGW 09T304	2,70	☐	■	☐	■	49,45
D-CCGW 09T308	2,70	☐	■	☐	■	49,45
D-CCGW 120404	2,70	☐	■	☐	■	49,45
D-CCGW 120408	2,70	☐	☐	☐	☐	49,45

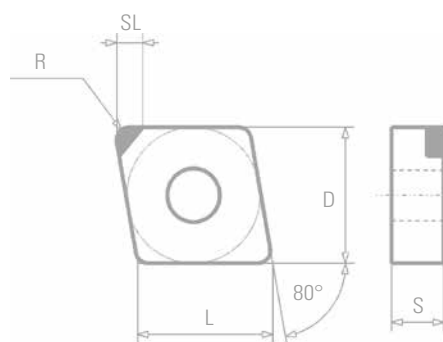

E-CNGA 120402	2,70	☐	■	☐	☐	29,79
E-CNGA 120404	2,70	☐	■	☐	■	29,79
E-CNGA 120408	2,70	☐	■	☐	■	29,79
E-CNGA 120412	2,70	☐	■	☐	■	29,79

Geometria Wiper destra e sinistra						
EW-CNGA 120404	2,70	☐	☐	☐	☐	33,81
EW-CNGA 120408	2,70	☐	☐	☐	☐	33,81

D-CNGA 120402	2,70	☐	☐	☐	☐	49,45
D-CNGA 120404	2,70	☐	■	☐	■	49,45
D-CNGA 120408	2,70	☐	■	☐	■	49,45

Geometria Wiper destra e sinistra						
DW-CNGA 120408	2,70	☐	☐	☐	☐	55,20

Mini riporto wiper



Due taglienti

Esempio d'ordine: CCGW 120404 HS33

**N.B. Prezzo cad. per 5 pz. e più. Ordinativo minimo 3 pz. Per 3 e 4 pezzi considerare maggiorazione +10%**

Vedi la descrizione delle leghe a pagina 6

- -disponibile a stock
- ☐ -disponibile in breve tempo su richiesta



**Inserti per tornitura con mini riporto**

Mini riporto wiper

**D**



Codice ISO	Quota SL	HS 61	HS 33	HS 62	CI 02	Prezzo €
E-DCGW 070202	2,70	<input type="checkbox"/>	<input checked="" type="checkbox"/>	<input type="checkbox"/>	<input checked="" type="checkbox"/>	29,79
E-DCGW 070204	2,70	<input type="checkbox"/>	<input checked="" type="checkbox"/>	<input type="checkbox"/>	<input checked="" type="checkbox"/>	29,79
E-DCGW 11T302	2,70	<input type="checkbox"/>	<input checked="" type="checkbox"/>	<input type="checkbox"/>	<input checked="" type="checkbox"/>	29,79
E-DCGW 11T304	2,70	<input type="checkbox"/>	<input checked="" type="checkbox"/>	<input type="checkbox"/>	<input checked="" type="checkbox"/>	29,79
E-DCGW 11T308	2,70	<input type="checkbox"/>	<input checked="" type="checkbox"/>	<input type="checkbox"/>	<input checked="" type="checkbox"/>	29,79



D-DCGW 070202	2,70	<input type="checkbox"/>	<input checked="" type="checkbox"/>	<input type="checkbox"/>	<input checked="" type="checkbox"/>	49,45
D-DCGW 070204	2,70	<input type="checkbox"/>	<input checked="" type="checkbox"/>	<input type="checkbox"/>	<input checked="" type="checkbox"/>	49,45
D-DCGW 11T302	2,70	<input type="checkbox"/>	<input checked="" type="checkbox"/>	<input type="checkbox"/>	<input type="checkbox"/>	49,45
D-DCGW 11T304	2,70	<input type="checkbox"/>	<input checked="" type="checkbox"/>	<input type="checkbox"/>	<input checked="" type="checkbox"/>	49,45
D-DCGW 11T308	2,70	<input type="checkbox"/>	<input checked="" type="checkbox"/>	<input type="checkbox"/>	<input checked="" type="checkbox"/>	49,45



E-DNGA 150402	2,70	<input type="checkbox"/>	<input type="checkbox"/>	<input type="checkbox"/>	<input type="checkbox"/>	29,79
E-DNGA 150404	2,70	<input type="checkbox"/>	<input checked="" type="checkbox"/>	<input type="checkbox"/>	<input checked="" type="checkbox"/>	29,79
E-DNGA 150408	2,70	<input type="checkbox"/>	<input checked="" type="checkbox"/>	<input type="checkbox"/>	<input type="checkbox"/>	29,79
E-DNGA 150602	2,70	<input type="checkbox"/>	<input type="checkbox"/>	<input type="checkbox"/>	<input checked="" type="checkbox"/>	29,79
E-DNGA 150604	2,70	<input type="checkbox"/>	<input checked="" type="checkbox"/>	<input type="checkbox"/>	<input checked="" type="checkbox"/>	29,79
E-DNGA 150608	2,70	<input type="checkbox"/>	<input checked="" type="checkbox"/>	<input type="checkbox"/>	<input type="checkbox"/>	29,79



D-DNGA 110404	2,70	<input type="checkbox"/>	<input checked="" type="checkbox"/>	<input type="checkbox"/>	<input type="checkbox"/>	49,45
D-DNGA 110408	2,70	<input type="checkbox"/>	<input checked="" type="checkbox"/>	<input type="checkbox"/>	<input type="checkbox"/>	49,45
D-DNGA 150604	2,70	<input type="checkbox"/>	<input checked="" type="checkbox"/>	<input type="checkbox"/>	<input checked="" type="checkbox"/>	49,45
D-DNGA 150608	2,70	<input type="checkbox"/>	<input checked="" type="checkbox"/>	<input type="checkbox"/>	<input checked="" type="checkbox"/>	49,45



Geometria Wiper a 93°*						
EW-DCGW 11T304 R	2,70	<input type="checkbox"/>	<input type="checkbox"/>	<input type="checkbox"/>	<input type="checkbox"/>	33,81
EW-DCGW 11T304 L	2,70	<input type="checkbox"/>	<input type="checkbox"/>	<input type="checkbox"/>	<input type="checkbox"/>	33,81
EW-DCGW 11T308 R	2,70	<input type="checkbox"/>	<input type="checkbox"/>	<input type="checkbox"/>	<input type="checkbox"/>	33,81
EW-DCGW 11T308 L	2,70	<input type="checkbox"/>	<input type="checkbox"/>	<input type="checkbox"/>	<input type="checkbox"/>	33,81



Due taglienti

Geometria Wiper a 93°*						
DW-DCGW 11T304 R	2,70	<input type="checkbox"/>	<input type="checkbox"/>	<input type="checkbox"/>	<input type="checkbox"/>	55,20
DW-DCGW 11T304 L	2,70	<input type="checkbox"/>	<input type="checkbox"/>	<input type="checkbox"/>	<input type="checkbox"/>	55,20
DW-DCGW 11T308 R	2,70	<input type="checkbox"/>	<input type="checkbox"/>	<input type="checkbox"/>	<input type="checkbox"/>	55,20
DW-DCGW 11T308 L	2,70	<input type="checkbox"/>	<input type="checkbox"/>	<input type="checkbox"/>	<input type="checkbox"/>	55,20

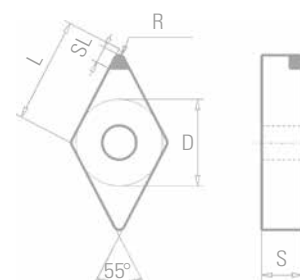
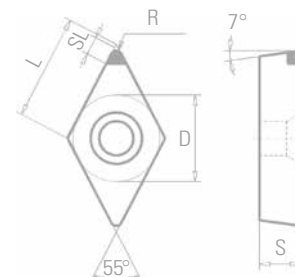

\*In riferimento agli inserti EW e DW-DCGW, la geometria Wiper lavora unicamente quando l'inserto è montato su portainserito a 93°

**Inserti per tornitura con mini riporto**

Mini riporto

**S**

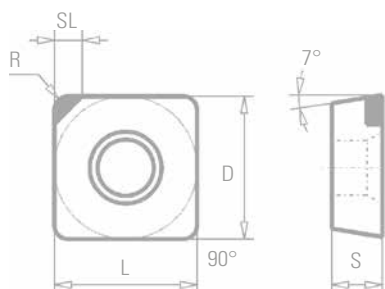

Codice ISO	Quota SL	HS 61	HS 33	HS 62	CI 02	Prezzo €
E-SCGW 09T302	2,70	<input type="checkbox"/>	<input type="checkbox"/>	<input type="checkbox"/>	<input type="checkbox"/>	29,79
E-SCGW 09T304	2,70	<input type="checkbox"/>	<input type="checkbox"/>	<input type="checkbox"/>	<input type="checkbox"/>	29,79
E-SCGW 09T308	2,70	<input type="checkbox"/>	<input type="checkbox"/>	<input type="checkbox"/>	<input type="checkbox"/>	29,79
E-SCGW 120404	2,70	<input type="checkbox"/>	<input type="checkbox"/>	<input type="checkbox"/>	<input type="checkbox"/>	29,79
E-SCGW 120408	2,70	<input type="checkbox"/>	<input type="checkbox"/>	<input type="checkbox"/>	<input checked="" type="checkbox"/>	29,79
E-SCGW 120412	2,70	<input type="checkbox"/>	<input type="checkbox"/>	<input type="checkbox"/>	<input type="checkbox"/>	29,79



Q-SCGW 120404	2,70	<input type="checkbox"/>	<input type="checkbox"/>	<input type="checkbox"/>	<input type="checkbox"/>	102,35
Q-SCGW 120408	2,70	<input type="checkbox"/>	<input type="checkbox"/>	<input type="checkbox"/>	<input type="checkbox"/>	102,35

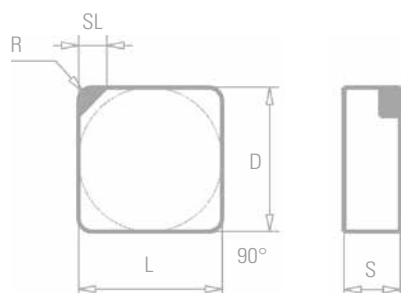

E-SNGN 120404	2,70	<input type="checkbox"/>	<input type="checkbox"/>	<input type="checkbox"/>	<input type="checkbox"/>	29,79
E-SNGN 120408	2,70	<input type="checkbox"/>	<input type="checkbox"/>	<input type="checkbox"/>	<input type="checkbox"/>	29,79



Q-SNGN 120404	2,70	<input type="checkbox"/>	<input type="checkbox"/>	<input type="checkbox"/>	<input type="checkbox"/>	102,35
Q-SNGN 120408	2,70	<input type="checkbox"/>	<input type="checkbox"/>	<input type="checkbox"/>	<input type="checkbox"/>	102,35

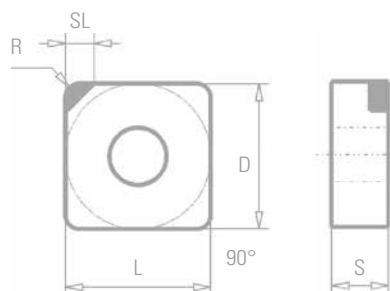

E-SNGA 120404	2,70	<input type="checkbox"/>	<input type="checkbox"/>	<input type="checkbox"/>	<input type="checkbox"/>	29,79
E-SNGA 120408	2,70	<input type="checkbox"/>	<input type="checkbox"/>	<input type="checkbox"/>	<input type="checkbox"/>	29,79



Q-SNGA 120404	2,70	<input type="checkbox"/>	<input type="checkbox"/>	<input type="checkbox"/>	<input type="checkbox"/>	102,35
Q-SNGA 120408	2,70	<input type="checkbox"/>	<input type="checkbox"/>	<input type="checkbox"/>	<input checked="" type="checkbox"/>	102,35

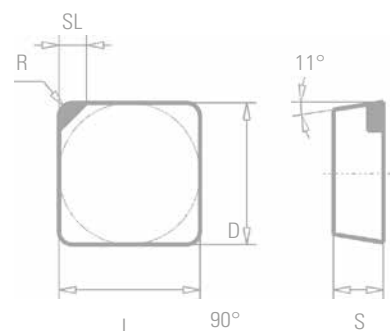

E-SPGN 120304	2,70	<input type="checkbox"/>	<input type="checkbox"/>	<input type="checkbox"/>	<input type="checkbox"/>	29,79
E-SPGN 120308	2,70	<input type="checkbox"/>	<input type="checkbox"/>	<input type="checkbox"/>	<input type="checkbox"/>	29,79
E-SPGN 120404	2,70	<input type="checkbox"/>	<input type="checkbox"/>	<input type="checkbox"/>	<input type="checkbox"/>	29,79
E-SPGN 120408	2,70	<input type="checkbox"/>	<input type="checkbox"/>	<input type="checkbox"/>	<input type="checkbox"/>	29,79



Q-SPGN 120304	2,70	<input type="checkbox"/>	<input type="checkbox"/>	<input type="checkbox"/>	<input type="checkbox"/>	102,35
Q-SPGN 120308	2,70	<input type="checkbox"/>	<input type="checkbox"/>	<input type="checkbox"/>	<input type="checkbox"/>	102,35
Q-SPGN 120404	2,70	<input type="checkbox"/>	<input type="checkbox"/>	<input type="checkbox"/>	<input type="checkbox"/>	102,35
Q-SPGN 120408	2,70	<input type="checkbox"/>	<input type="checkbox"/>	<input type="checkbox"/>	<input type="checkbox"/>	102,35



Esempio d'ordine: CCGW 120404 HS33

**N.B. Prezzo cad. per 5 pz. e più. Ordinativo minimo 3 pz. Per 3 e 4 pezzi considerare maggiorazione +10%**

Vedi la descrizione delle leghe a pagina 6

- disponibile a stock
- disponibile in breve tempo su richiesta

**Inseri per tornitura con mini riporto**

Mini riporto



Codice ISO	Quota SL	HS 61	HS 33	HS 62	CI 02	Prezzo €
E-TCGW 090202	2,70	<input type="checkbox"/>	<input type="checkbox"/>	<input type="checkbox"/>	<input type="checkbox"/>	29,79
E-TCGW 090204	2,70	<input type="checkbox"/>	<input type="checkbox"/>	<input type="checkbox"/>	<input type="checkbox"/>	29,79
E-TCGW 110202	2,70	<input type="checkbox"/>	<input checked="" type="checkbox"/>	<input type="checkbox"/>	<input checked="" type="checkbox"/>	29,79
E-TCGW 110204	2,70	<input type="checkbox"/>	<input checked="" type="checkbox"/>	<input type="checkbox"/>	<input checked="" type="checkbox"/>	29,79
E-TCGW 110208	2,70	<input type="checkbox"/>	<input checked="" type="checkbox"/>	<input type="checkbox"/>	<input type="checkbox"/>	29,79
E-TCGW 130304	2,70	<input type="checkbox"/>	<input type="checkbox"/>	<input type="checkbox"/>	<input type="checkbox"/>	29,79
E-TCGW 130308	2,70	<input type="checkbox"/>	<input type="checkbox"/>	<input type="checkbox"/>	<input type="checkbox"/>	29,79
E-TCGW 16T302	2,70	<input type="checkbox"/>	<input type="checkbox"/>	<input type="checkbox"/>	<input type="checkbox"/>	29,79
E-TCGW 16T304	2,70	<input type="checkbox"/>	<input checked="" type="checkbox"/>	<input type="checkbox"/>	<input checked="" type="checkbox"/>	29,79
E-TCGW 16T308	2,70	<input type="checkbox"/>	<input checked="" type="checkbox"/>	<input type="checkbox"/>	<input checked="" type="checkbox"/>	29,79
E-TCGW 16T312	2,70	<input type="checkbox"/>	<input type="checkbox"/>	<input type="checkbox"/>	<input type="checkbox"/>	29,79

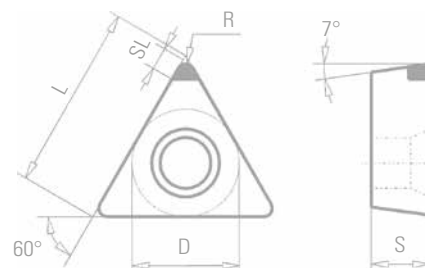

T-TCGW 16T304	2,70	<input type="checkbox"/>	<input type="checkbox"/>	<input type="checkbox"/>	<input type="checkbox"/>	82,80
T-TCGW 16T308	2,70	<input type="checkbox"/>	<input type="checkbox"/>	<input type="checkbox"/>	<input type="checkbox"/>	82,80



E-TNGA 160404	2,70	<input type="checkbox"/>	<input type="checkbox"/>	<input type="checkbox"/>	<input type="checkbox"/>	29,79
E-TNGA 160408	2,70	<input type="checkbox"/>	<input checked="" type="checkbox"/>	<input type="checkbox"/>	<input checked="" type="checkbox"/>	29,79



T-TNGA 160404	2,70	<input type="checkbox"/>	<input checked="" type="checkbox"/>	<input type="checkbox"/>	<input checked="" type="checkbox"/>	82,80
T-TNGA 160408	2,70	<input type="checkbox"/>	<input type="checkbox"/>	<input type="checkbox"/>	<input checked="" type="checkbox"/>	82,80

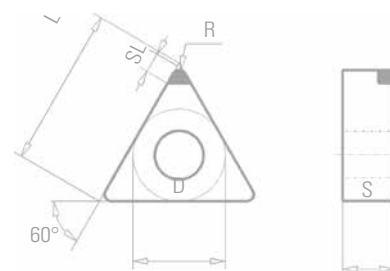

E-TPGN 110202	2,70	<input type="checkbox"/>	<input type="checkbox"/>	<input type="checkbox"/>	<input type="checkbox"/>	29,79
E-TPGN 110204	2,70	<input type="checkbox"/>	<input type="checkbox"/>	<input type="checkbox"/>	<input type="checkbox"/>	29,79
E-TPGN 110208	2,70	<input type="checkbox"/>	<input type="checkbox"/>	<input type="checkbox"/>	<input type="checkbox"/>	29,79
E-TPGN 110302	2,70	<input type="checkbox"/>	<input type="checkbox"/>	<input type="checkbox"/>	<input type="checkbox"/>	29,79
E-TPGN 110304	2,70	<input type="checkbox"/>	<input type="checkbox"/>	<input type="checkbox"/>	<input type="checkbox"/>	29,79
E-TPGN 110308	2,70	<input type="checkbox"/>	<input type="checkbox"/>	<input type="checkbox"/>	<input type="checkbox"/>	29,79
E-TPGN 160304	2,70	<input type="checkbox"/>	<input type="checkbox"/>	<input type="checkbox"/>	<input type="checkbox"/>	29,79
E-TPGN 160308	2,70	<input type="checkbox"/>	<input type="checkbox"/>	<input type="checkbox"/>	<input type="checkbox"/>	29,79

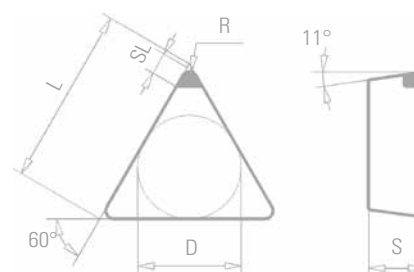

E-TPGW 110202	2,70	<input type="checkbox"/>	<input type="checkbox"/>	<input type="checkbox"/>	<input type="checkbox"/>	29,79
E-TPGW 110204	2,70	<input type="checkbox"/>	<input type="checkbox"/>	<input type="checkbox"/>	<input type="checkbox"/>	29,79
E-TPGW 110302	2,70	<input type="checkbox"/>	<input type="checkbox"/>	<input type="checkbox"/>	<input type="checkbox"/>	29,79
E-TPGW 110304	2,70	<input type="checkbox"/>	<input type="checkbox"/>	<input type="checkbox"/>	<input type="checkbox"/>	29,79



T-TPGN 160304	2,70	<input type="checkbox"/>	<input type="checkbox"/>	<input type="checkbox"/>	<input type="checkbox"/>	82,80
T-TPGN 160308	2,70	<input type="checkbox"/>	<input type="checkbox"/>	<input type="checkbox"/>	<input type="checkbox"/>	82,80

Esempio d'ordine: CCGW 120404 HS33

N.B. Prezzo cad. per 5 pz. e più. Ordinativo minimo 3 pz. Per 3 e 4 pezzi considerare maggiorazione +10%

Vedi la descrizione delle leghe a pagina 6

■ -disponibile a stock

□ -disponibile in breve tempo su richiesta

**Inserti per tornitura con mini riporto**

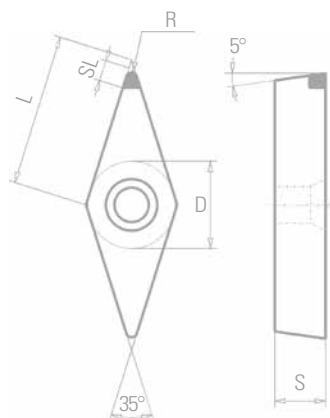

Codice ISO	Quota SL	HS 61	HS 33	HS 62	CI 02	Prezzo €
E-VBGW 110201	3,00	<input type="checkbox"/>	<input type="checkbox"/>	<input type="checkbox"/>	<input checked="" type="checkbox"/>	€30,94
E-VBGW 110202	3,00	<input type="checkbox"/>	<input type="checkbox"/>	<input type="checkbox"/>	<input checked="" type="checkbox"/>	€30,94
E-VBGW 110204	3,00	<input type="checkbox"/>	<input type="checkbox"/>	<input type="checkbox"/>	<input checked="" type="checkbox"/>	€30,94
E-VBGW 160402	3,00	<input type="checkbox"/>	<input type="checkbox"/>	<input type="checkbox"/>	<input type="checkbox"/>	€30,94
E-VBGW 160404	3,00	<input type="checkbox"/>	<input checked="" type="checkbox"/>	<input type="checkbox"/>	<input checked="" type="checkbox"/>	€30,94
E-VBGW 160408	3,00	<input type="checkbox"/>	<input checked="" type="checkbox"/>	<input type="checkbox"/>	<input checked="" type="checkbox"/>	€30,94
E-VBGW 160412	3,00	<input type="checkbox"/>	<input type="checkbox"/>	<input type="checkbox"/>	<input type="checkbox"/>	€30,94

D-VBGW 160402	3,00	<input type="checkbox"/>	<input type="checkbox"/>	<input type="checkbox"/>	<input type="checkbox"/>	51,75
D-VBGW 160404	3,00	<input type="checkbox"/>	<input checked="" type="checkbox"/>	<input type="checkbox"/>	<input type="checkbox"/>	51,75
D-VBGW 160408	3,00	<input type="checkbox"/>	<input type="checkbox"/>	<input type="checkbox"/>	<input checked="" type="checkbox"/>	51,75

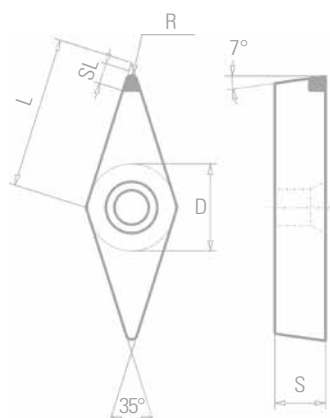

E-VCGW 110302	3,00	<input type="checkbox"/>	<input type="checkbox"/>	<input type="checkbox"/>	<input type="checkbox"/>	€30,94
E-VCGW 110304	3,00	<input type="checkbox"/>	<input type="checkbox"/>	<input type="checkbox"/>	<input type="checkbox"/>	€30,94
E-VCGW 160402	3,00	<input type="checkbox"/>	<input type="checkbox"/>	<input type="checkbox"/>	<input type="checkbox"/>	€30,94
E-VCGW 160404	3,00	<input type="checkbox"/>	<input checked="" type="checkbox"/>	<input type="checkbox"/>	<input checked="" type="checkbox"/>	€30,94
E-VCGW 160408	3,00	<input type="checkbox"/>	<input checked="" type="checkbox"/>	<input type="checkbox"/>	<input checked="" type="checkbox"/>	€30,94
E-VCGW 160412	3,00	<input type="checkbox"/>	<input checked="" type="checkbox"/>	<input type="checkbox"/>	<input type="checkbox"/>	€30,94

D-VCGW 110302	3,00	<input type="checkbox"/>	<input type="checkbox"/>	<input type="checkbox"/>	<input type="checkbox"/>	€1,75
D-VCGW 110304	3,00	<input type="checkbox"/>	<input checked="" type="checkbox"/>	<input type="checkbox"/>	<input type="checkbox"/>	€1,75
D-VCGW 130302	3,00	<input type="checkbox"/>	<input type="checkbox"/>	<input type="checkbox"/>	<input type="checkbox"/>	€1,75
D-VCGW 130304	3,00	<input type="checkbox"/>	<input type="checkbox"/>	<input type="checkbox"/>	<input type="checkbox"/>	€1,75
D-VCGW 160404	3,00	<input type="checkbox"/>	<input checked="" type="checkbox"/>	<input type="checkbox"/>	<input checked="" type="checkbox"/>	€1,75
D-VCGW 160408	3,00	<input type="checkbox"/>	<input checked="" type="checkbox"/>	<input type="checkbox"/>	<input type="checkbox"/>	€1,75

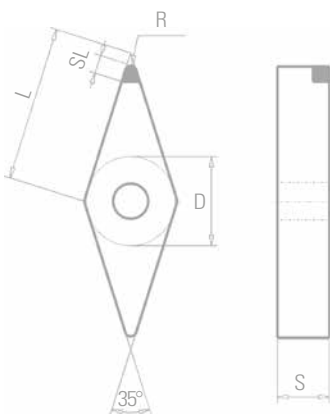

E-VNGA 160402	3,00	<input type="checkbox"/>	<input type="checkbox"/>	<input type="checkbox"/>	<input type="checkbox"/>	30,94
E-VNGA 160404	3,00	<input type="checkbox"/>	<input checked="" type="checkbox"/>	<input type="checkbox"/>	<input checked="" type="checkbox"/>	30,94
E-VNGA 160408	3,00	<input type="checkbox"/>	<input type="checkbox"/>	<input type="checkbox"/>	<input type="checkbox"/>	30,94

D-VNGA 160402	3,00	<input type="checkbox"/>	<input type="checkbox"/>	<input type="checkbox"/>	<input type="checkbox"/>	51,75
D-VNGA 160404	3,00	<input type="checkbox"/>	<input checked="" type="checkbox"/>	<input type="checkbox"/>	<input checked="" type="checkbox"/>	51,75
D-VNGA 160408	3,00	<input type="checkbox"/>	<input checked="" type="checkbox"/>	<input type="checkbox"/>	<input type="checkbox"/>	51,75

Mini riporto



**Esempio d'ordine: CCGW 120404 HS33**

Vedi la descrizione delle leghe a pagina 6

**N.B. Prezzo cad. per 5 pz. e più. Ordinativo minimo 3 pz. Per 3 e 4 pezzi considerare maggiorazione +10%**

-disponibile a stock

-disponibile in breve tempo su richiesta