

11P



Porte outils et plaquettes

Portainsero e inserti

I

Porte outils
Portainsero
B11P

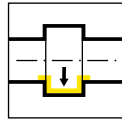

Page/Pag.
274-275

Plaque
Inserto
11P/S11P

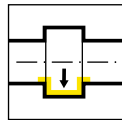

Page/Pag.
276, 279



Page/Pag.
277, 280

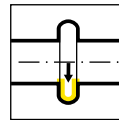

Page/Pag.
278

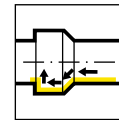

Page/Pag.
281, 285

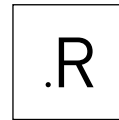

Page/Pag.
282

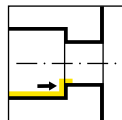

Page/Pag.
283

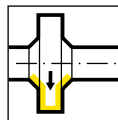

Page/Pag.
284

| Ø Alésage Foro Ø | Type de produit / Linea di prodotto | | | | | | | | | | | |
|--|-------------------------------------|-------------|-------------|-------------|-------------|-------------|-------------|-------------|-------------|--------------|-------------|-------------|
| | 105 | 109 | 110 | 106 | 107 | 108 | 10P | 111 | 11P | 114 | 116 | 18P |
| ≥ 0,2 | • | | | | | | | | | | | |
| ≥ 0,5 | • | | | | | | | | | | | |
| ≥ 0,7 | • | | | | | | | | | | | |
| ≥ 1,0 | • | | | | | | | | | | | |
| ≥ 1,5 | • | | | | | | | | | | | |
| ≥ 2,0 | • | | | | | | | | | | | |
| ≥ 3,0 | • | | | | | | | | | | | |
| ≥ 4,0 | • | | | | | | | | | | | |
| ≥ 5,0 | • | | | | | | | | | | | |
| ≥ 6,0 | • | • | • | • | | | | | | | | |
| ≥ 6,8 | | • | • | • | | | | | | | | |
| ≥ 7,0 | | • | | | • | | | | | | | |
| ≥ 7,8 | | | • | | • | • | | | | | | |
| ≥ 8,0 | | | • | | • | • | | | | | | |
| ≥ 9,0 | | | • | | • | • | • | | | | | |
| ≥ 10,0 | | | • | | | | • | • | • | | | |
| ≥ 10,5 | | | | | | | | | • | | | |
| ≥ 11,0 | | | | | | | | • | • | | | |
| ≥ 11,5 | | | | | | | | | • | | | |
| ≥ 13,8 | | | | | | | | | | • | | |
| ≥ 14,0 | | | | | | | | | | • | • | |
| ≥ 16,0 | | | | | | | | | | | • | |
| ≥ 16,5 | | | | | | | | | | {•} | | |
| ≥ 18,0 | | | | | | | | | | | | • |
| Profondeur de gorge Profondità della gola | 2,5 | 2,5 | 4,0 | 0,8 | 2,0 | 1,0 | 3,0 | 2,3 | 3,5 | 4,0 (6,5) | 4,3 | 8,0 |
| Largeur de gorge Larghezza della gola | 0,5- 2,0 | 1,0- 2,0 | 1,0- 3,0 | 0,7- 1,5 | 1,0- 2,0 | 0,7- 2,0 | 1,0- 3,0 | 0,7- 3,0 | 1,0- 3,0 | 0,7- 3,0 | 0,7- 4,0 | 2,0- 3,0 |
| Usinage / Operazione | | | | | | | | | | | | |
| Gorge Gole | • | • | • | • | • | • | • | • | • | • | • | • |
| Alésage Alesatura | • | • | • | • | • | • | | • | | • | • | |
| Filetage Filettatura | • | • | | | • | • | | • | | • | • | |
| Chanfreinage Smussatura | • | • | | | • | • | | • | | • | • | |
| Gorge frontale Gole assiali | • | • | • | | | | | | | • | | |
| Alésage et Profil Alesatura e Profilatura | • | | | | | | | | | | | |

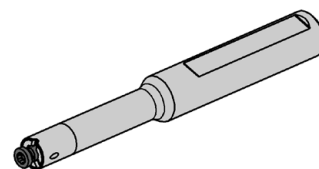
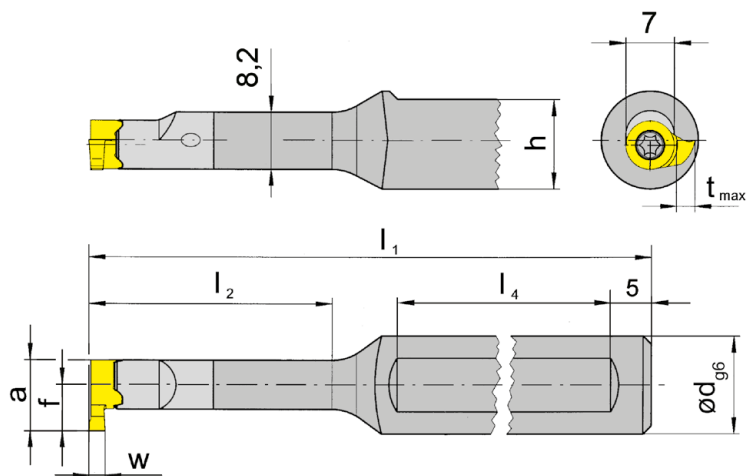
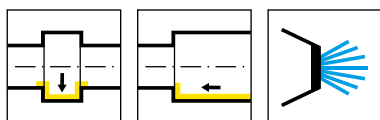

R = version à droite représentée
R = versione destra come in figura

L = version à gauche
L = versione sinistra a specchio

| N° de commande Codice prodotto | d | l ₁ | l ₂ | h | l ₄ | HWS |
|-----------------------------------|----|----------------|----------------|----|----------------|---------|
| RB11P.0012.00 | 12 | 75 | 15 | 11 | 40 | 11P070R |
| RB11P.0012.01 | 12 | 95 | 26 | 11 | 50 | 11P070R |
| RB11P.0012.02 | 12 | 110 | 37 | 11 | 50 | 11P070R |
| RB11P.0012.03 | 12 | 120 | 50 | 11 | 50 | 11P070R |
| LB11P.0012.00 | 12 | 75 | 15 | 11 | 40 | 11P070L |
| LB11P.0012.01 | 12 | 95 | 26 | 11 | 50 | 11P070L |
| LB11P.0012.02 | 12 | 110 | 37 | 11 | 50 | 11P070L |
| LB11P.0012.03 | 12 | 120 | 50 | 11 | 50 | 11P070L |

w, a, t_max et f voir plaquettes
w, a, t_max, f vd. Inserti

Pièces Détachées

Ricambi

| Porte outils Portainsero | Vis de serrage Vite di serraggio | Tournevis TORX PLUS® Cacciavite TORX PLUS® |
|-----------------------------|-------------------------------------|---|
| R/LB11P... | 3.10T9P | T9PL |

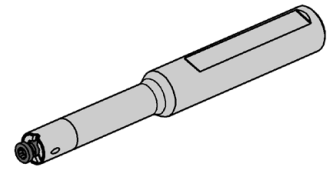
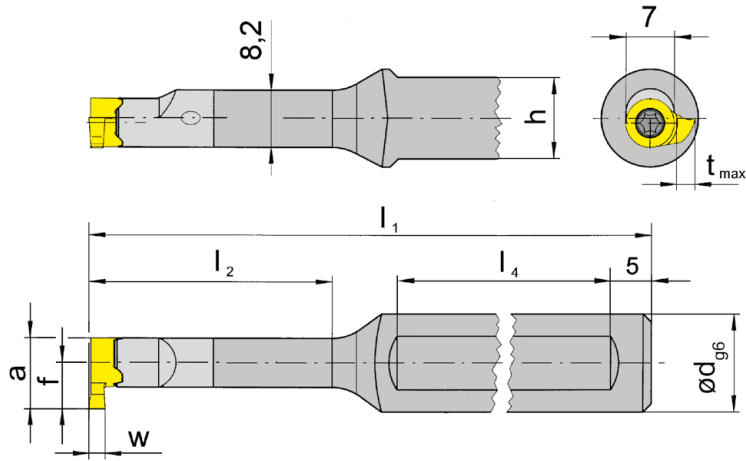
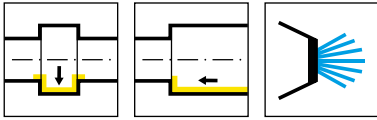

R = version à droite représentée
R = versione destra come in figura

L = version à gauche
L = versione sinistra a specchio

| N° de commande Codice prodotto | d | l ₁ | l ₂ | h | l ₄ | HWS |
|-----------------------------------|----|----------------|----------------|----|----------------|---------|
| RB11P.0012.2.00 | 12 | 75 | 15 | 11 | 40 | 11P070R |
| RB11P.0012.2.01 | 12 | 95 | 26 | 11 | 50 | 11P070R |
| RB11P.0012.2.02 | 12 | 110 | 37 | 11 | 50 | 11P070R |
| RB11P.0012.2.03 | 12 | 120 | 50 | 11 | 50 | 11P070R |
| LB11P.0012.2.00 | 12 | 75 | 15 | 11 | 40 | 11P070L |
| LB11P.0012.2.01 | 12 | 95 | 26 | 11 | 50 | 11P070L |
| LB11P.0012.2.02 | 12 | 110 | 37 | 11 | 50 | 11P070L |
| LB11P.0012.2.03 | 12 | 120 | 50 | 11 | 50 | 11P070L |

w, a, t_max et f voir plaquettes
w, a, t_max, f vd. Inserti

Pièces Détachées

Ricambi

| Porte outils Portainsero | Vis de serrage Vite di serraggio | Tournevis TORX PLUS® Cacciavite TORX PLUS® |
|-----------------------------|-------------------------------------|---|
| R/LB11P... | 3.10T9P | T9PL |

Plaquette Inserto

11P

$\varnothing \geq 10,5 \text{ mm}$

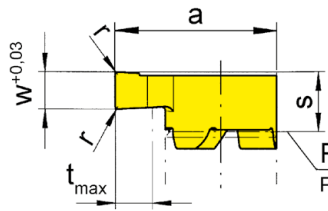
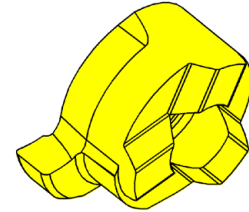
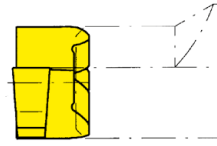
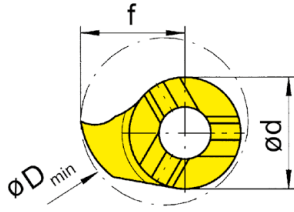
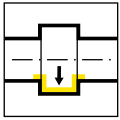

Profil frontal du porte outils
Profilo frontale del portainsero

R = version à droite représentée
R = versione destra come in figura

L = version à gauche
L = versione sinistra a specchio

▲ en stock
a stock

Nuance
Leghe
Δ 4 semaines
4 settimane

| N° de commande Codice prodotto | w | s | f | a | r | d | t _{max} | D _{min} | HIS | Nuance Leghe | |
|-----------------------------------|-----|-----|-----|----|-----|---|------------------|------------------|---------|-----------------|------|
| | | | | | | | | | | EG55 | TH35 |
| R11P.0100.1.00 | 1 | 4,2 | 6,5 | 10 | - | 7 | 2,5 | 10,5 | 11P070R | ▲ | ▲ |
| R11P.0150.1.00 | 1,5 | 4,2 | 6,5 | 10 | - | 7 | 2,5 | 10,5 | 11P070R | ▲ | ▲ |
| R11P.0200.1.02 | 2 | 4,2 | 6,5 | 10 | 0,2 | 7 | 2,5 | 10,5 | 11P070R | ▲ | ▲ |
| R11P.0250.1.02 | 2,5 | 4,2 | 6,5 | 10 | 0,2 | 7 | 2,5 | 10,5 | 11P070R | ▲ | ▲ |
| R11P.0300.1.02 | 3 | 4,2 | 6,5 | 10 | 0,2 | 7 | 2,5 | 10,5 | 11P070R | Δ | ▲ |
| L11P.0100.1.00 | 1 | 4,2 | 6,5 | 10 | - | 7 | 2,5 | 10,5 | 11P070L | Δ | ▲ |
| L11P.0150.1.00 | 1,5 | 4,2 | 6,5 | 10 | - | 7 | 2,5 | 10,5 | 11P070L | Δ | Δ |
| L11P.0200.1.02 | 2 | 4,2 | 6,5 | 10 | 0,2 | 7 | 2,5 | 10,5 | 11P070L | ▲ | ▲ |
| L11P.0250.1.02 | 2,5 | 4,2 | 6,5 | 10 | 0,2 | 7 | 2,5 | 10,5 | 11P070L | Δ | ▲ |
| L11P.0300.1.02 | 3 | 4,2 | 6,5 | 10 | 0,2 | 7 | 2,5 | 10,5 | 11P070L | Δ | ▲ |
| | | | | | | | | | | P | ● ● |
| | | | | | | | | | | M | ○ ● |
| | | | | | | | | | | K | ○ ● |
| | | | | | | | | | | N | - ● |
| | | | | | | | | | | S | - ● |
| | | | | | | | | | | H | - - |

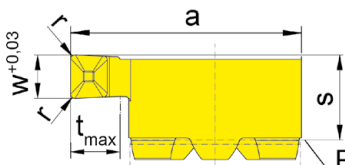
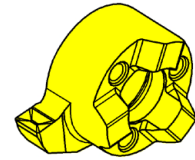
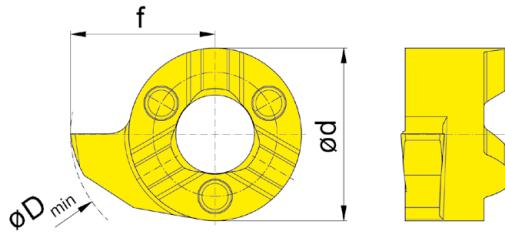
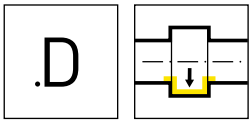

Profil frontal du porte outils
Profilo frontale del portainsero

R = version à droite représentée
R = versione destra come in figura

L = version à gauche
L = versione sinistra a specchio

▲ en stock
a stock

Nuance
Leghe
Δ 4 semaines
4 settimane

| N° de commande Codice prodotto | w | s | f | a | r | d | t _{max} | D _{min} | HIS | EG55 | TH35 |
|-----------------------------------|-----|-----|-----|----|-----|---|------------------|------------------|---------|-------|------|
| RS11P.0150.1.D1 | 1,5 | 4,2 | 6,5 | 10 | 0,1 | 7 | 2,5 | 10,5 | 11P070R | ▲ | ▲ |
| RS11P.0200.1.D2 | 2 | 4,2 | 6,5 | 10 | 0,2 | 7 | 2,5 | 10,5 | 11P070R | ▲ | ▲ |
| RS11P.0250.1.D2 | 2,5 | 4,2 | 6,5 | 10 | 0,2 | 7 | 2,5 | 10,5 | 11P070R | ▲ | ▲ |
| LS11P.0150.1.D1 | 1,5 | 4,2 | 6,5 | 10 | 0,1 | 7 | 2,5 | 10,5 | 11P070L | Δ | ▲ |
| LS11P.0200.1.D2 | 2 | 4,2 | 6,5 | 10 | 0,2 | 7 | 2,5 | 10,5 | 11P070L | Δ | ▲ |
| LS11P.0250.1.D2 | 2,5 | 4,2 | 6,5 | 10 | 0,2 | 7 | 2,5 | 10,5 | 11P070L | Δ | Δ |
| | | | | | | | | | | P ● ● | |
| | | | | | | | | | | M ○ ● | |
| | | | | | | | | | | K ○ ● | |
| | | | | | | | | | | N - ● | |
| | | | | | | | | | | S - ● | |
| | | | | | | | | | | H - - | |



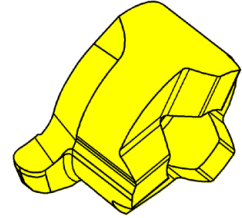
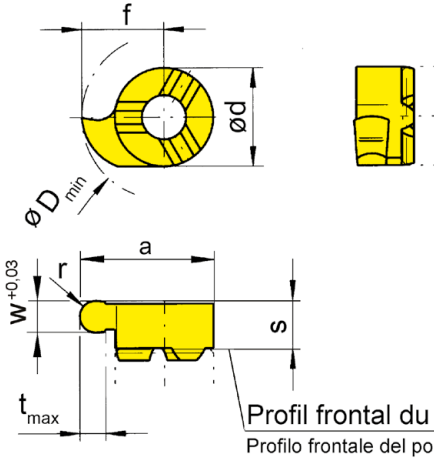
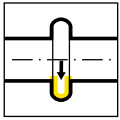

R = version à droite représentée
R = versione destra come in figura

L = version à gauche
L = versione sinistra a specchio

▲ en stock
a stock

Nuance
Leghe
Δ 4 semaines
4 settimane

| N° de commande Codice prodotto | w | s | f | a | t _{max} | D _{min} | HIS | EG55 |
|-----------------------------------|-----|-----|---|----|------------------|------------------|---------|------|
| R11P.0005.2.10 | 1 | 4,2 | 7 | 11 | 3,5 | 11,5 | 11P070R | ▲ |
| R11P.0007.2.15 | 1,5 | 4,2 | 7 | 11 | 3,5 | 11,5 | 11P070R | ▲ |
| R11P.0009.2.18 | 1,8 | 4,2 | 7 | 11 | 3,5 | 11,5 | 11P070R | ▲ |
| R11P.0010.2.20 | 2 | 4,2 | 7 | 11 | 3,5 | 11,5 | 11P070R | ▲ |
| L11P.0005.2.10 | 1 | 4,2 | 7 | 11 | 3,5 | 11,5 | 11P070L | ▲ |
| L11P.0007.2.15 | 1,5 | 4,2 | 7 | 11 | 3,5 | 11,5 | 11P070L | ▲ |
| L11P.0009.2.18 | 1,8 | 4,2 | 7 | 11 | 3,5 | 11,5 | 11P070L | ▲ |
| L11P.0010.2.20 | 2 | 4,2 | 7 | 11 | 3,5 | 11,5 | 11P070L | ▲ |
| | | | | | | | P ● | |
| | | | | | | | M o | |
| | | | | | | | K o | |
| | | | | | | | N - | |
| | | | | | | | S - | |
| | | | | | | | H - | |

Plaquette Inserto

11P

$\varnothing \geq 11,5 \text{ mm}$

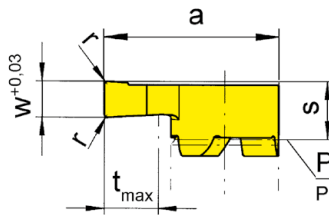
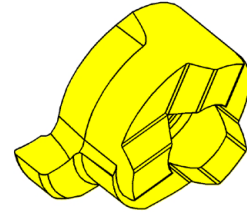
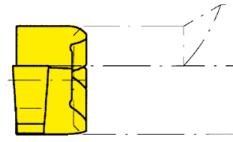
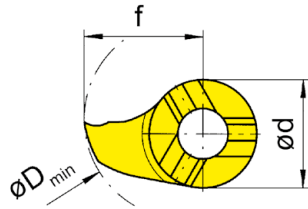
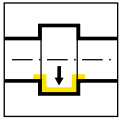

Profil frontal du porte outils
Profilo frontale del portainsero

R = version à droite représentée
R = versione destra come in figura

L = version à gauche
L = versione sinistra a specchio

▲ en stock
a stock

Nuance
Leghe
Δ 4 semaines
4 settimane

| N° de commande Codice prodotto | w | s | f | a | r | d | t _{max} | D _{min} | HIS | EG55 | TH35 |
|-----------------------------------|-----|-----|-----|----|-----|---|------------------|------------------|---------|------|------|
| R11P.0100.2.00 | 1 | 4,2 | 7,5 | 11 | - | 7 | 3,5 | 11,5 | 11P070R | ▲ | ▲ |
| R11P.0150.2.00 | 1,5 | 4,2 | 7,5 | 11 | - | 7 | 3,5 | 11,5 | 11P070R | ▲ | ▲ |
| R11P.0200.2.02 | 2 | 4,2 | 7,5 | 11 | 0,2 | 7 | 3,5 | 11,5 | 11P070R | ▲ | ▲ |
| L11P.0100.2.00 | 1 | 4,2 | 7,5 | 11 | - | 7 | 3,5 | 11,5 | 11P070L | Δ | ▲ |
| L11P.0150.2.00 | 1,5 | 4,2 | 7,5 | 11 | - | 7 | 3,5 | 11,5 | 11P070L | Δ | ▲ |
| L11P.0200.2.02 | 2 | 4,2 | 7,5 | 11 | 0,2 | 7 | 3,5 | 11,5 | 11P070L | ▲ | ▲ |
| | | | | | | | | | | P | ● |
| | | | | | | | | | | M | ○ |
| | | | | | | | | | | K | ○ |
| | | | | | | | | | | N | - |
| | | | | | | | | | | S | - |
| | | | | | | | | | | H | - |



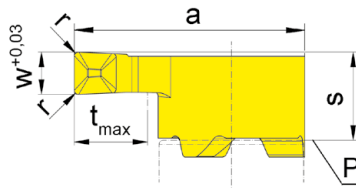
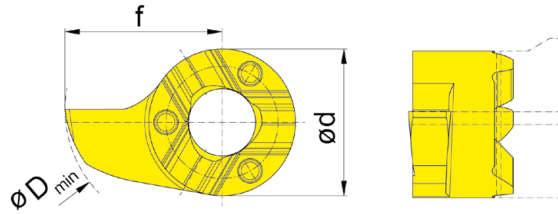
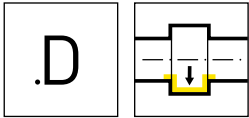

Profil frontal du porte outils
Profilo frontale del portainsero

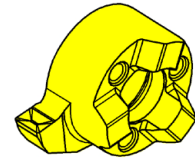

R = version à droite représentée
R = versione destra come in figura

L = version à gauche
L = versione sinistra a specchio

▲ en stock
a stock

Nuance
Leghe
Δ 4 semaines
4 settimane

| N° de commande Codice prodotto | w | s | f | a | r | d | t _{max} | D _{min} | HIS | EG55 | TH35 |
|-----------------------------------|-----|-----|-----|----|-----|---|------------------|------------------|---------|------|------|
| RS11P.0150.2.D1 | 1,5 | 4,2 | 7,5 | 11 | 0,1 | 7 | 3,5 | 11,5 | 11P070R | ▲ | ▲ |
| RS11P.0200.2.D2 | 2 | 4,2 | 7,5 | 11 | 0,2 | 7 | 3,5 | 11,5 | 11P070R | ▲ | ▲ |
| RS11P.0250.2.D2 | 2,5 | 4,2 | 7,5 | 11 | 0,2 | 7 | 3,5 | 11,5 | 11P070R | ▲ | ▲ |
| LS11P.0150.2.D1 | 1,5 | 4,2 | 7,5 | 11 | 0,1 | 7 | 3,5 | 11,5 | 11P070L | Δ | ▲ |
| LS11P.0200.2.D2 | 2 | 4,2 | 7,5 | 11 | 0,2 | 7 | 3,5 | 11,5 | 11P070L | ▲ | ▲ |
| LS11P.0250.2.D2 | 2,5 | 4,2 | 7,5 | 11 | 0,2 | 7 | 3,5 | 11,5 | 11P070L | Δ | ▲ |
| | | | | | | | | | | P | ● |
| | | | | | | | | | | M | ○ |
| | | | | | | | | | | K | ○ |
| | | | | | | | | | | N | - |
| | | | | | | | | | | S | - |
| | | | | | | | | | | H | - |

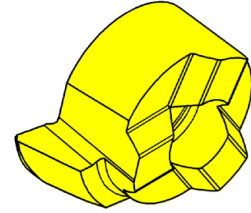
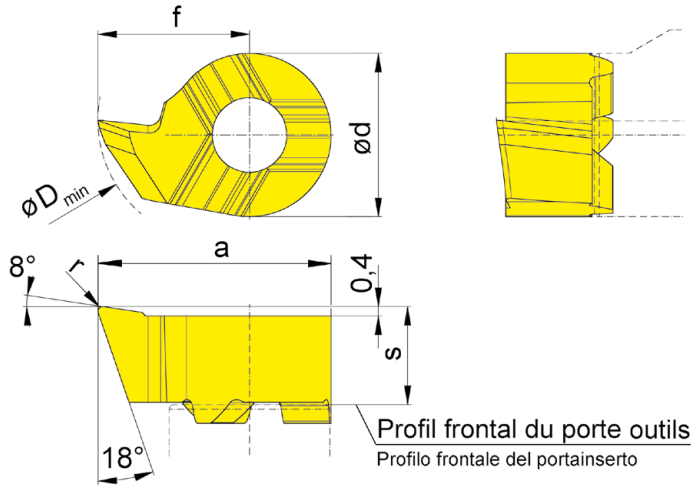
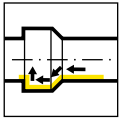

R = version à droite représentée
R = versione destra come in figura

L = version à gauche
L = versione sinistra a specchio

▲ en stock
a stock

Nuance
Leghe
Δ 4 semaines
4 settimane

| N° de commande Codice prodotto | s | f | a | r | d | D _{min} | HIS | Nuance Leghe | |
|-----------------------------------|-----|-----|----|-----|---|------------------|---------|-----------------|------|
| | | | | | | | | EG55 | TH35 |
| R11P.1865.1.02 | 4,2 | 6,5 | 10 | 0,2 | 7 | 10,5 | 11P070R | ▲ | ▲ |
| L11P.1865.1.02 | 4,2 | 6,5 | 10 | 0,2 | 7 | 10,5 | 11P070L | Δ | ▲ |
| | | | | | | | | P ● ● | |
| | | | | | | | | M ○ ● | |
| | | | | | | | | K ○ ● | |
| | | | | | | | | N - ● | |
| | | | | | | | | S - ● | |
| | | | | | | | | H - - | |

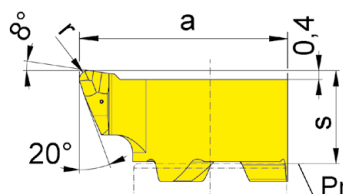
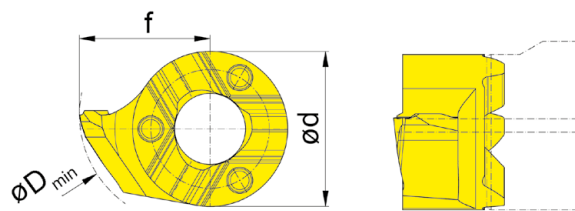
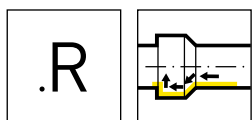

Profil frontal du porte outils
Profilo frontale del portainsero

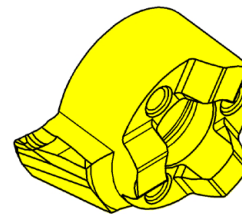

R = version à droite représentée
R = versione destra come in figura

L = version à gauche
L = versione sinistra a specchio

▲ en stock
a stock

Nuance
Leghe
Δ 4 semaines
4 settimane

| N° de commande Codice prodotto | s | f | a | r | d | D _{min} | HIS | Nuance Leghe | |
|-----------------------------------|-----|-----|-----|-----|---|------------------|---------|-----------------|------|
| | | | | | | | | EG55 | TH35 |
| RS11P.1859.R2 | 4,2 | 5,9 | 9,4 | 0,2 | 7 | 9,8 | 11P070R | ▲ | ▲ |
| RS11P.1859.R4 | 4,2 | 5,9 | 9,4 | 0,4 | 7 | 9,8 | 11P070R | ▲ | ▲ |
| LS11P.1859.R2 | 4,2 | 5,9 | 9,4 | 0,2 | 7 | 9,8 | 11P070L | | ▲ |
| LS11P.1859.R4 | 4,2 | 5,9 | 9,4 | 0,4 | 7 | 9,8 | 11P070L | ▲ | ▲ |
| | | | | | | | | P | ● ● |
| | | | | | | | | M | ○ ● |
| | | | | | | | | K | ○ ● |
| | | | | | | | | N | - ● |
| | | | | | | | | S | - ● |
| | | | | | | | | H | - - |

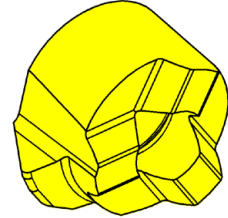
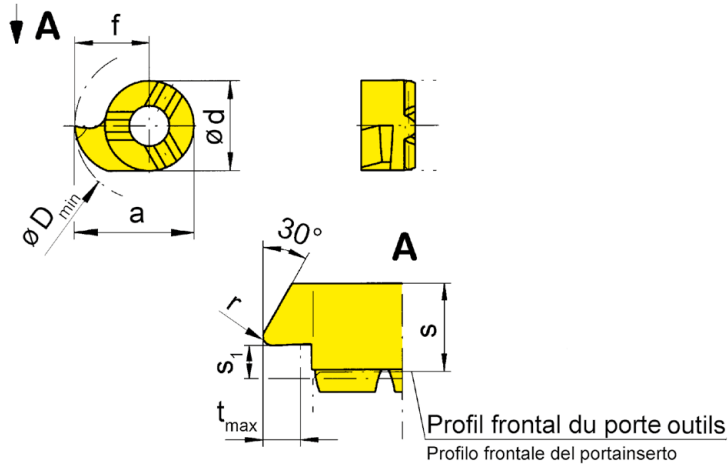
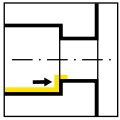

R = version à droite représentée
R = versione destra come in figura

L = version à gauche
L = versione sinistra a specchio

▲ en stock
a stock

Nuance
Leghe
Δ 4 semaines
4 settimane

| N° de commande Codice prodotto | s | f | a | r | s ₁ | d | t _{max} | D _{min} | HIS | EG55 |
|-----------------------------------|------|-----|----|-----|----------------|---|------------------|------------------|---------|------|
| R11P.3075.2.02 | 4,35 | 7,5 | 11 | 0,2 | 1,6 | 7 | 3,5 | 11,5 | 11P070R | ▲ |
| L11P.3075.2.02 | 4,35 | 7,5 | 11 | 0,2 | 1,6 | 7 | 3,5 | 11,5 | 11P070L | ▲ |
| | | | | | | | | | | P ● |
| | | | | | | | | | | M ○ |
| | | | | | | | | | | K ○ |
| | | | | | | | | | | N - |
| | | | | | | | | | | S - |
| | | | | | | | | | | H - |



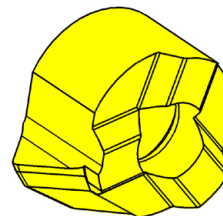
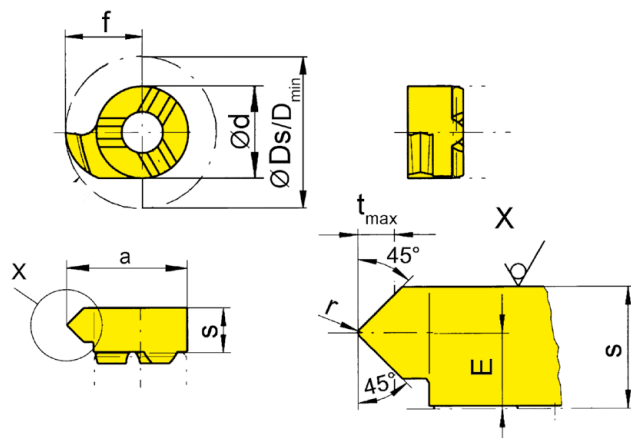
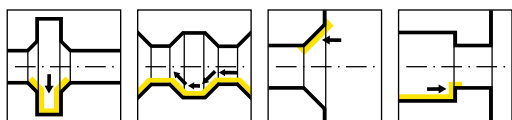

R = version à droite représentée
R = versione destra come in figura

L = version à gauche
L = versione sinistra a specchio

▲ en stock
a stock

Nuance
Leghe
Δ 4 semaines
4 settimane

| N° de commande Codice prodotto | E | f | r | d | D _{min} | α | t _{max} | HIS | EG55 |
|-----------------------------------|-----|-----|-----|---|------------------|-----|------------------|---------|------|
| R11P.4545.1.02 | 2,2 | 6,5 | 0,2 | 7 | 10,5 | 45° | 1,7 | 11P070R | ▲ |
| L11P.4545.1.02 | 2,2 | 6,5 | 0,2 | 7 | 10,5 | 45° | 1,7 | 11P070L | ▲ |
| | | | | | | | | | P ● |
| | | | | | | | | | M ○ |
| | | | | | | | | | K ○ |
| | | | | | | | | | N - |
| | | | | | | | | | S - |
| | | | | | | | | | H - |

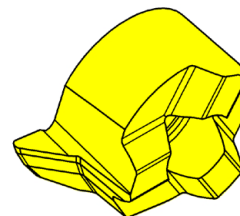
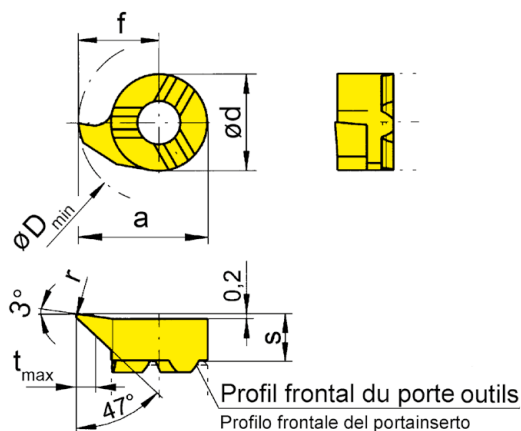
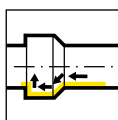

Nuance
Leghe

R = version à droite représentée
R = versione destra come in figura

L = version à gauche
L = versione sinistra a specchio

▲ en stock
a stock

Δ 4 semaines
4 settimane

| N° de commande Codice prodotto | s | f | a | r | d | t _{max} | D _{min} | HIS | EG55 |
|-----------------------------------|-----|-----|----|-----|---|------------------|------------------|---------|------|
| R11P.4775.2.02 | 4,2 | 7,5 | 11 | 0,2 | 7 | 3,5 | 11,5 | 11P070R | ▲ |
| L11P.4775.2.02 | 4,2 | 7,5 | 11 | 0,2 | 7 | 3,5 | 11,5 | 11P070L | ▲ |
| | | | | | | | | | P ● |
| | | | | | | | | | M ○ |
| | | | | | | | | | K ○ |
| | | | | | | | | | N - |
| | | | | | | | | | S - |
| | | | | | | | | | H - |