

M310



F

Fraise disque
Corps de fraise vissé
Fraise à moyeu

Largeur de rainure 3 - 5 mm
Diamètre de coupe 50 - 200 mm

Frese a disco
Fresa avvitabile
Fresa a manicotto

Larghezza della cava 3 - 5 mm
Diametro Ds 50 - 200 mm

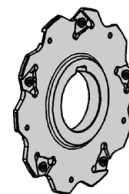
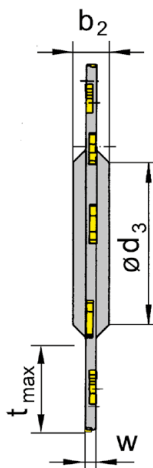
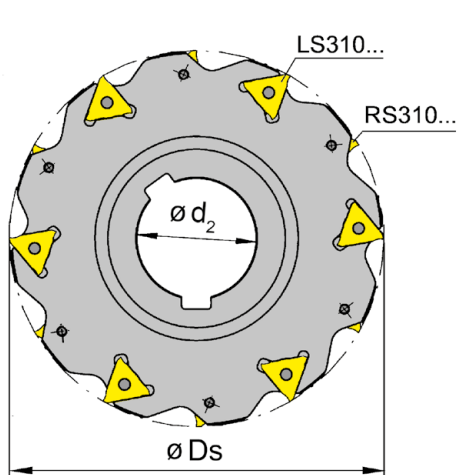
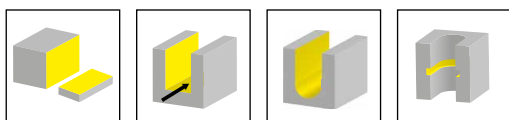

Illustration de coupe à droite représentée
Figura = taglio destro

F

N° de commande Codice prodotto	Z	Ds	t _{max}	d ₂	b ₂	d ₃	w	Plaquette à droite Inserto destro	Plaquette à gauche Inserto sinistro	HWS
M310.0080.27.03	8	80	18	27	8	40	3	4x RS310.3017...	4x LS310.3017...	310017R • 310017L
M310.0080.27.04	8	80	18	27	8	40	4	4x RS310.4023...	4x LS310.4023...	310023R • 310023L
M310.0080.27.05	8	80	18	27	8	40	5	4x RS310.5028...	4x LS310.5028...	310028R • 310028L
M310.0100.32.03	10	100	25	32	8	46	3	5x RS310.3017...	5x LS310.3017...	310017R • 310017L
M310.0100.32.04	10	100	25	32	8	46	4	5x RS310.4023...	5x LS310.4023...	310023R • 310023L
M310.0100.32.05	10	100	25	32	8	46	5	5x RS310.5028...	5x LS310.5028...	310028R • 310028L
M310.0125.40.03	12	125	32	40	10	54	3	6x RS310.3017...	6x LS310.3017...	310017R • 310017L
M310.0125.40.04	12	125	32	40	10	54	4	6x RS310.4023...	6x LS310.4023...	310023R • 310023L
M310.0125.40.05	12	125	32	40	10	54	5	6x RS310.5028...	6x LS310.5028...	310028R • 310028L
M310.0160.40.03	16	160	50	40	10	54	3	8x RS310.3017...	8x LS310.3017...	310017R • 310017L
M310.0160.40.04	16	160	50	40	10	54	4	8x RS310.4023...	8x LS310.4023...	310023R • 310023L
M310.0160.40.05	16	160	50	40	10	54	5	8x RS310.5028...	8x LS310.5028...	310028R • 310028L
M310.0200.40.04	20	200	70	40	10	54	4	10x RS310.4023...	10x LS310.4023...	310023R • 310023L
M310.0200.40.05	20	200	70	40	10	54	5	10x RS310.5028...	10x LS310.5028...	310028R • 310028L

Alésage [d2] rainure selon DIN 138
Foro [d2] con chiavetta longitudinale secondo DIN 138

Pièces Détachées

Ricambi

Fraise disque Frese a disco	Vis de serrage Vite di serraggio	Tournevis TORX PLUS® Cacciavite TORX PLUS®
M310...03	030.0324.T7P	T7PL
M310...04	030.3535.T8P	T8PL
M310...05	030.3543.T8P	T8PL

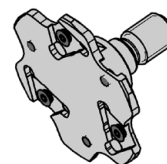
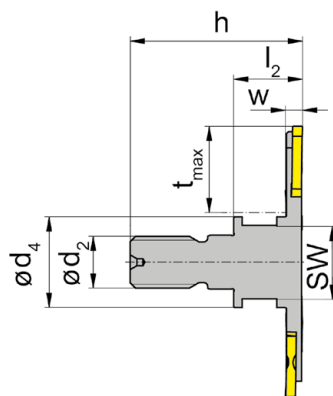
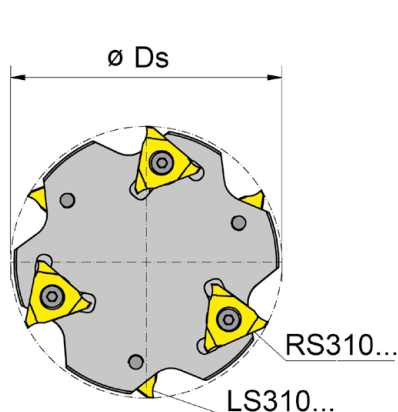
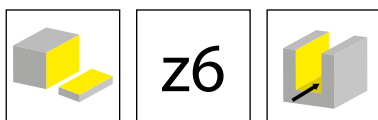

Illustration de coupe à droite représentée
Figura = taglio destro

N° de commande Codice prodotto	Z	Ds	h	l_2	d_2	d_4	SW	w	t_{max}	Plaquette à droite Inserto destro	Plaquette à gauche Inserto sinistro	HWS	HMS
M310.0050.M10.03	6	50	33	13	M10	18	15	3	15	3x RS310.3017...	3x LS310.3017...	310017R • 310017L	10001
M310.0050.M10.04	6	50	34	14	M10	18	15	4	15	3x RS310.4023...	3x LS310.4023...	310023R • 310023L	10001
M310.0050.M10.05	6	50	35	15	M10	18	15	5	15	3x RS310.5028...	3x LS310.5028...	310028R • 310028L	10001
M310.0063.M12.03	6	63	39	15	M12	21	17	3	20	3x RS310.3017...	3x LS310.3017...	310017R • 310017L	12001
M310.0063.M12.04	6	63	40	16	M12	21	17	4	20	3x RS310.4023...	3x LS310.4023...	310023R • 310023L	12001
M310.0063.M12.05	6	63	41	17	M12	21	17	5	20	3x RS310.5028...	3x LS310.5028...	310028R • 310028L	12001

Pièces Détachées

Ricambi

Corps de fraise vissé Fresa avvitabile	Vis de serrage Vite di serraggio	Tournevis TORX PLUS® Cacciavite TORX PLUS®
M310...03	030.0324.T7P	T7PL
M310...04	030.3535.T8P	T8PL
M310...05	030.3543.T8P	T8PL



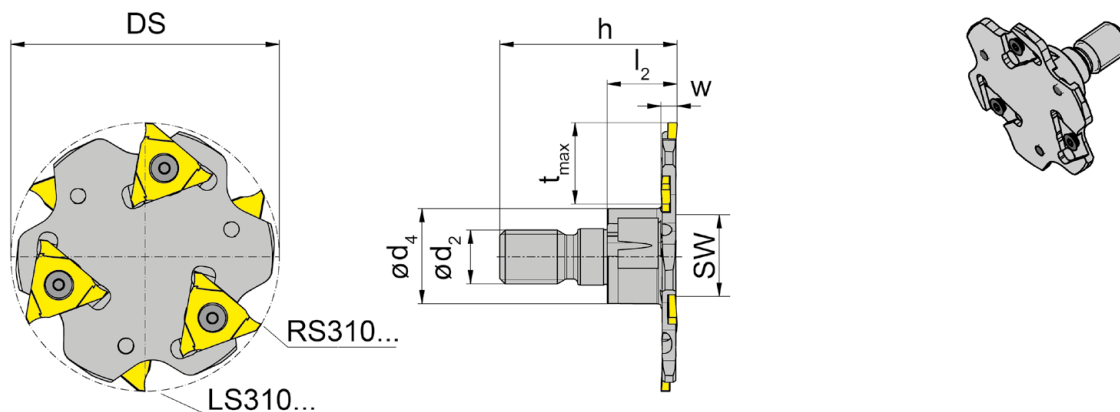
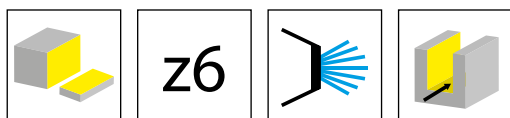

Illustration de coupe à droite représentée
Figura = taglio destro

F

N° de commande Codice prodotto	Z	Ds	h	l ₂	d ₂	d ₄	SW	w	t _{max}	Plaquette à droite Inserto destro	Plaquette à gauche Inserto sinistro	HWS	HMS
M310.0050.M10.03.IK	6	50	33	13	M10	18	15	3	15	3x RS310.3017...	3x LS310.3017...	310017R • 310017L	10001
M310.0050.M10.04.IK	6	50	34	14	M10	18	15	4	15	3x RS310.4023...	3x LS310.4023...	310023R • 310023L	10001
M310.0050.M10.05.IK	6	50	35	15	M10	18	15	5	15	3x RS310.5028...	3x LS310.5028...	310028R • 310028L	10001
M310.0063.M12.03.IK	6	63	39	15	M12	21	17	3	20	3x RS310.3017...	3x LS310.3017...	310017R • 310017L	12001
M310.0063.M12.04.IK	6	63	40	16	M12	21	17	4	20	3x RS310.4023...	3x LS310.4023...	310023R • 310023L	12001
M310.0063.M12.05.IK	6	63	41	17	M12	21	17	5	20	3x RS310.5028...	3x LS310.5028...	310028R • 310028L	12001

Pièces Détachées

Ricambi

Corps de fraise vissé Fresa avvitabile	Vis de serrage Vite di serraggio	Tournevis TORX PLUS® Cacciavite TORX PLUS®
M310...03	030.0324.T7P	T7PL
M310...04	030.3535.T8P	T8PL
M310...05	030.3543.T8P	T8PL

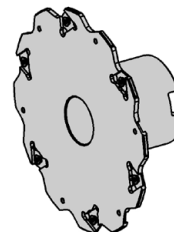
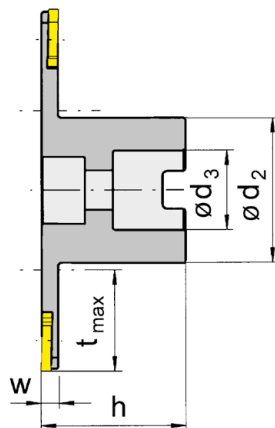
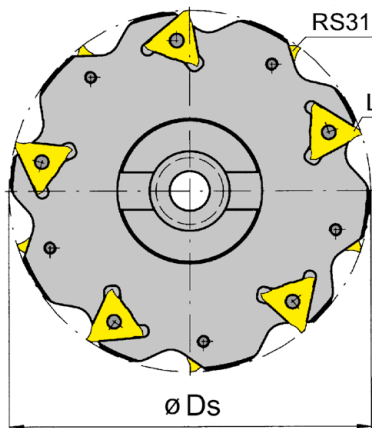
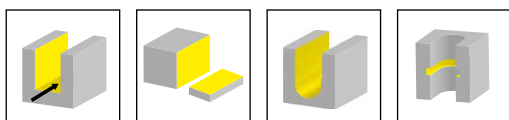

Illustration de coupe à droite représentée
Figura = taglio destro

N° de commande Codice prodotto	Z	Ds	t _{max}	h	d ₂	d ₃	w	Plaquette à droite Inserto destro	Plaquette à gauche Inserto sinistro	HWS
M310.0080.22.03	8	80	23	40	33	22	3	4x RS310.3017...	4x LS310.3017...	310017R • 310017L
M310.1100.27.03	10	100	25	50	48	27	3	5x RS310.3017...	5x LS310.3017...	310017R • 310017L
M310.1125.27.03	12	125	35,7	50	48	27	3	6x RS310.3017...	6x LS310.3017...	310017R • 310017L
M310.1125.32.03	12	125	32,5	50	58	32	3	6x RS310.3017...	6x LS310.3017...	310017R • 310017L
M310.1125.40.03	12	125	26,5	50	70	40	3	6x RS310.3017...	6x LS310.3017...	310017R • 310017L
M310.1160.40.03	16	160	44	50	70	40	3	6x RS310.3017...	6x LS310.3017...	310017R • 310017L

Alésage (d3) rainure selon DIN 138
Foro (d3) con chiavetta trasversale secondo DIN 138

Pièces Détachées

Ricambi

Fraise à moyeu Fresa a manicotto	Vis de serrage Vite di serraggio	Tournevis TORX PLUS® Cacciavite TORX PLUS®
M310...	030.0324.T7P	T7PL



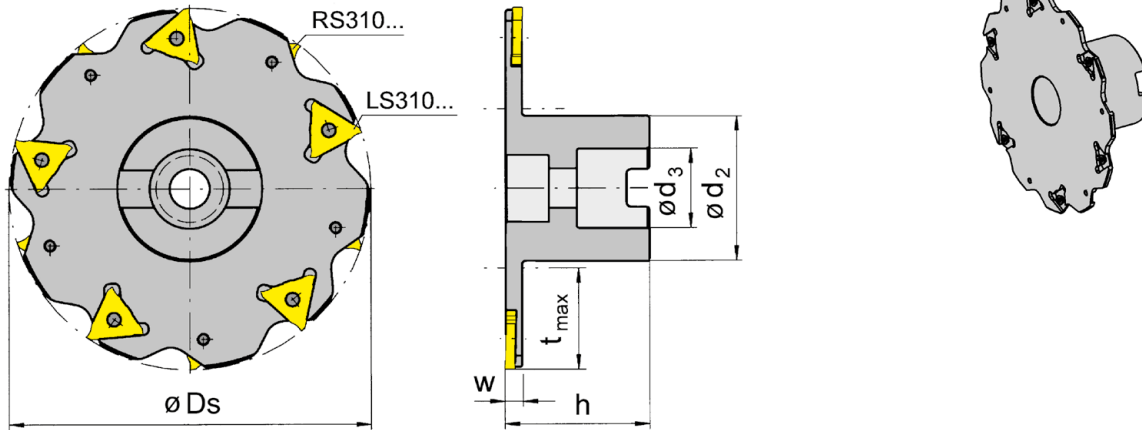
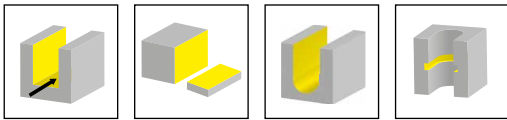

Illustration de coupe à droite représentée
Figura = taglio destro

F

N° de commande Codice prodotto	Z	Ds	t _{max}	h	d ₂	d ₃	w	Plaquette à droite Inserto destro	Plaquette à gauche Inserto sinistro	HWS
M310.0080.22.04	8	80	23	40	33	22	4	4x RS310.4023...	4x LS310.4023...	310023R • 310023L
M310.0080.22.05	8	80	23	40	33	22	5	4x RS310.5028...	4x LS310.5028...	310028R • 310028L
M310.1100.27.04	10	100	25	50	48	27	4	5x RS310.4023...	5x LS310.4023...	310023R • 310023L
M310.1100.27.05	10	100	25	50	48	27	5	5x RS310.5028...	5x LS310.5028...	310028R • 310028L
M310.1125.27.04	12	125	37,5	50	48	27	4	6x RS310.4023...	6x LS310.4023...	310023R • 310023L
M310.1125.32.04	12	125	32	50	56	32	4	6x RS310.4023...	6x LS310.4023...	310023R • 310023L
M310.1125.40.04	12	125	26,5	50	70	40	4	6x RS310.4023...	6x LS310.4023...	310023R • 310023L
M310.1125.27.05	12	125	37,5	50	48	27	5	6x RS310.5028...	6x LS310.5028...	310028R • 310028L
M310.1125.32.05	12	125	32,5	50	56	32	5	6x RS310.5028...	6x LS310.5028...	310028R • 310028L
M310.1125.40.05	12	125	26,5	50	70	40	5	6x RS310.5028...	6x LS310.5028...	310028R • 310028L
M310.1160.40.04	16	160	44	50	70	40	4	8x RS310.4023...	8x LS310.4023...	310023R • 310023L
M310.1160.40.05	16	160	44	50	70	40	5	8x RS310.5028...	8x LS310.5028...	310028R • 310028L
M310.1200.40.04	20	200	64	50	70	40	4	10x RS310.4023...	10x LS310.4023...	310023R • 310023L
M310.1200.40.05	20	200	64	50	70	40	5	10x RS310.5028...	10x LS310.5028...	310028R • 310028L

Alésage [d3] rainure selon DIN 138
Foro [d3] con chiavetta trasversale secondo DIN 138

Pièces Détachées

Ricambi

Fraise à moyeu Fresa a manicotto	Vis de serrage Vite di serraggio	Tournevis TORX PLUS® Cacciavite TORX PLUS®
M310...04	030.3535.T8P	T8PL
M310...05	030.3543.T8P	T8PL

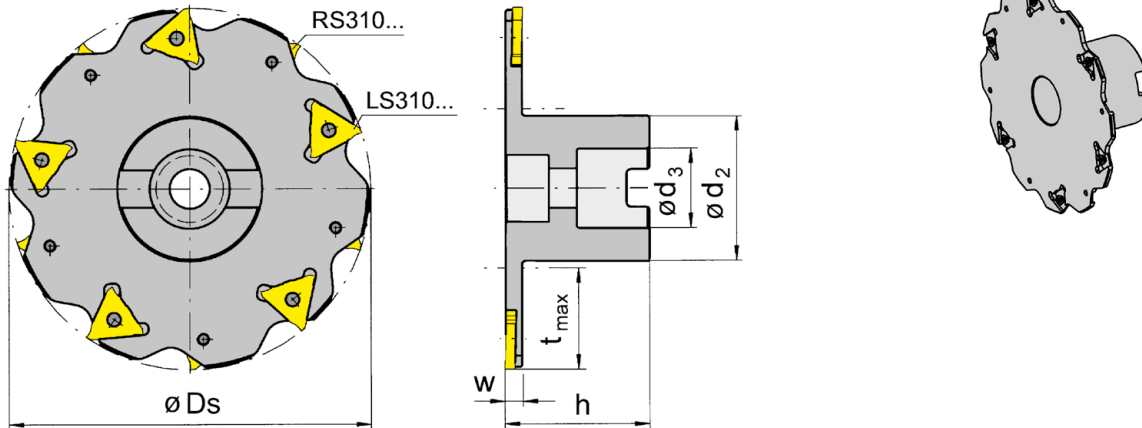
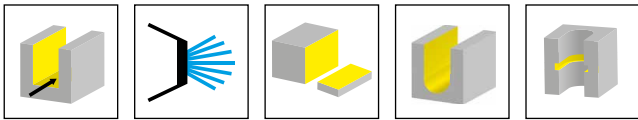

Illustration de coupe à droite représentée
Figura = taglio destro

N° de commande Codice prodotto	Z	Ds	t _{max}	h	d ₂	d ₃	w	Plaquette à droite Inserto destro	Plaquette à gauche Inserto sinistro	HWS
M310.0063.16.03.IK	6	63	17,5	35	26	16	3	3x RS310.3017...	3x LS310.3017...	310017R • 310017L
M310.0063.16.04.IK	6	63	17,5	35	26	16	4	3x RS310.4023...	3x LS310.4023...	310023R • 310023L
M310.0063.16.05.IK	6	63	17,5	35	26	16	5	3x RS310.5028...	3x LS310.5028...	310028R • 310028L
M310.0080.16.03.IK	8	80	25	40	28	16	3	4x RS310.3017...	4x LS310.3017...	310017R • 310017L
M310.0080.16.04.IK	8	80	25	40	28	16	4	4x RS310.4023...	4x LS310.4023...	310023R • 310023L
M310.0080.16.05.IK	8	80	25	40	28	16	5	4x RS310.5028...	4x LS310.5028...	310028R • 310028L
M310.0080.22.03.IK	8	80	23	40	33	22	3	4x RS310.3017...	4x LS310.3017...	310017R • 310017L
M310.0080.22.04.IK	8	80	23	40	33	22	4	4x RS310.4023...	4x LS310.4023...	310023R • 310023L
M310.0080.22.05.IK	8	80	23	40	33	22	5	4x LS310.5028...	4x RS310.5028...	310028R • 310028L
M310.1100.27.03.IK	10	100	25	50	48	27	3	5x RS310.3017...	5x LS310.3017...	310017R • 310017L
M310.1100.27.04.IK	10	100	25	50	48	27	4	5x RS310.4023...	5x LS310.4023...	310023R • 310023L

Alésage [d3] rainure selon DIN 138
Foro [d3] con chiavetta trasversale secondo DIN 138

Pièces Détachées

Ricambi

Fraise à moyeu Fresa a manicotto	Vis de serrage Vite di serraggio	Tournevis TORX PLUS® Cacciavite TORX PLUS®
M310...03	030.0324.T7P	T7PL
M310...04	030.3535.T8P	T8PL
M310...05	030.3543.T8P	T8PL

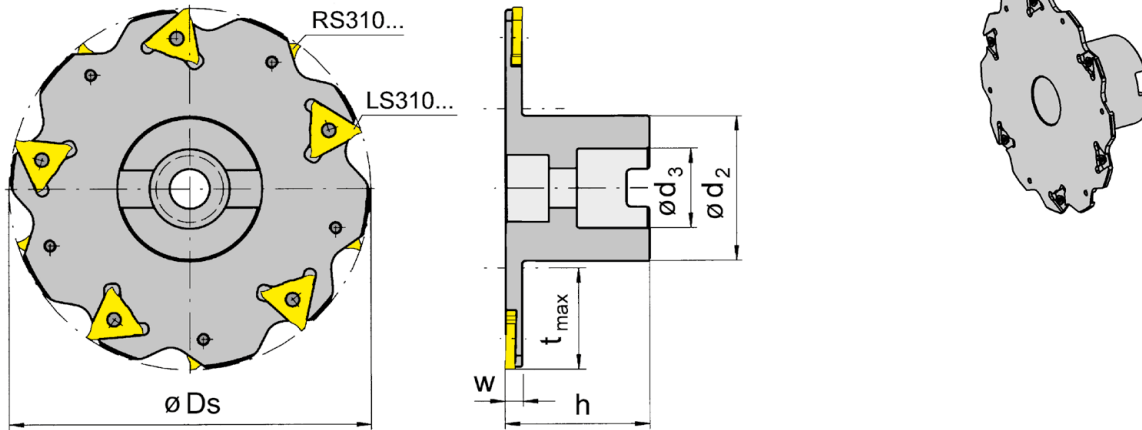
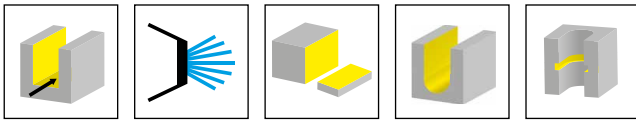

Illustration de coupe à droite représentée
Figura = taglio destro

F

N° de commande Codice prodotto	Z	Ds	t _{max}	h	d ₂	d ₃	w	Plaquette à droite Inserto destro	Plaquette à gauche Inserto sinistro	HWS
M310.1125.27.03.IK	12	125	37,5	50	48	27	3	6x RS310.3017...	6x LS310.3017...	310017R • 310017L
M310.1125.27.04.IK	12	125	37,5	50	48	27	4	6x RS310.4023...	6x LS310.4023...	310023R • 310023L
M310.1125.27.05.IK	12	125	37,5	50	48	27	5	6x RS310.5028...	6x LS310.5028...	310028R • 310028L
M310.1125.32.03.IK	12	125	32	50	56	32	3	6x LS310.3017...	6x LS310.3017...	310017R • 310017L
M310.1125.32.04.IK	12	125	32	50	56	32	4	6x LS310.4023...	6x RS310.4023...	310023R • 310023L
M310.1125.32.05.IK	12	125	32	50	56	32	5	6x LS310.5028...	6x RS310.5028...	310028R • 310028L
M310.1125.40.05.IK	12	125	26,5	50	70	40	5	6x RS310.5028...	6x LS310.5028...	310028R • 310028L
M310.1160.40.03.IK	16	160	44	50	70	40	3	8x RS310.3017...	8x LS310.3017...	310017R • 310017L
M310.1160.40.04.IK	16	160	44	50	70	40	4	8x RS310.4023...	8x LS310.4023...	310023R • 310023L
M310.1160.40.05.IK	16	160	44	50	70	40	5	8x LS310.5028...	3x RS310.5028...	310028R • 310028L
M310.1200.40.04.IK	20	200	64	50	70	40	4	10x LS310.4023...	10x RS310.4023...	310023R • 310023L
M310.1200.40.05.IK	20	200	64	50	70	40	5	10x LS310.5028...	10x RS310.5028...	310028R • 310028L

Alésage [d3] rainure selon DIN 138
Foro [d3] con chiavetta trasversale secondo DIN 138

Pièces Détachées

Ricambi

Fraise à moyeu Fresa a manicotto	Vis de serrage Vite di serraggio	Tournevis TORX PLUS® Cacciavite TORX PLUS®
M310...03	030.0324.T7P	T7PL
M310...04	030.3535.T8P	T8PL
M310...05	030.3543.T8P	T8PL

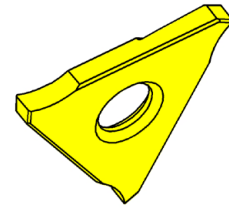
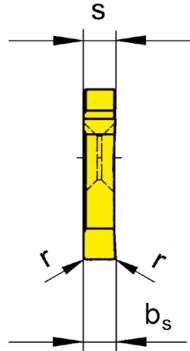
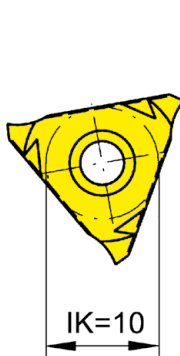
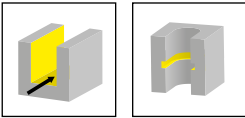

R = version à droite représentée
R = versione destra come in figura

L = version à gauche
L = versione sinistra a specchio

▲ en stock
a stock

Δ 4 semaines
4 settimane

Nuance
Leghe

N° de commande Codice prodotto	w	r	b _s	s	HIS					
						AS45	DD25	IG35	TF45	TN35
RS310.3017.00	3	0,15	1,7	1,6	310017R	▲	▲	▲		
RS310.3118.00	3,175	0,15	1,8	1,6	310017R	▲	▲	▲		
RS310.4023.00	4	0,2	2,3	2,2	310023R	▲	▲	▲	▲	▲
RS310.5028.00	5	0,2	2,8	2,7	310028R	▲	▲	▲	▲	▲
LS310.3017.00	3	0,15	1,7	1,6	310017L	▲	▲	▲		
LS310.3118.00	3,175	0,15	1,8	1,6	310017L	▲	▲	▲		
LS310.4023.00	4	0,2	2,3	2,2	310023L	▲	▲	▲	▲	▲
LS310.5028.00	5	0,2	2,8	2,7	310028L	▲	▲	▲	▲	▲
P						●	-	-	●	●
M						●	-	●	●	●
K						●	-	-	●	●
N						o	●	-	●	●
S						●	o	●	●	●
H						-	-	-	-	-



Plaquette amovible

Inserto

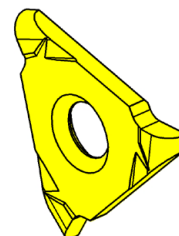
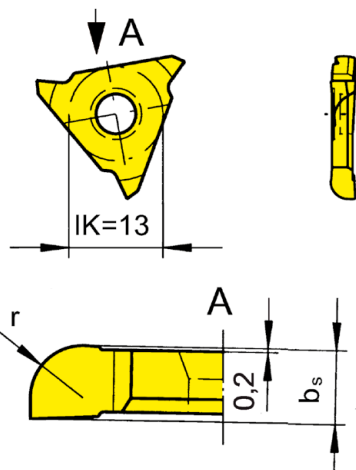
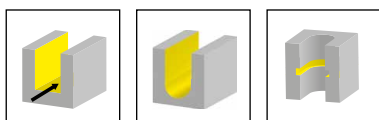

Nuance
Leghe

R = version à droite représentée
R = versione destra come in figura

L = version à gauche
L = versione sinistra a specchio

▲ en stock
a stock

Δ 4 semaines
4 settimane

F

N° de commande Codice prodotto	w	r	b _s	s	HIS	AS45
RS310.3017.04	3	0,4	1,7	1,57	310017R	Δ
RS310.3017.05	3	0,5	1,7	1,57	310017R	Δ
RS310.3017.10	3	1	1,7	1,57	310017R	▲
RS310.3017.15	3	1,5	1,7	1,57	310017R	Δ
RS310.4023.04	4	0,4	2,3	2,17	310023R	Δ
RS310.4023.05	4	0,5	2,3	2,17	310023R	Δ
RS310.4023.10	4	1	2,3	2,17	310023R	▲
RS310.4023.15	4	1,5	2,3	2,17	310023R	Δ
RS310.4023.16	4	1,6	2,3	2,17	310023R	Δ
RS310.4023.20	4	2	2,3	2,17	310023R	▲
LS310.3017.04	3	0,4	1,7	1,57	310017L	Δ
LS310.3017.05	3	0,5	1,7	1,57	310017L	Δ
LS310.3017.10	3	1	1,7	1,57	310017L	▲
LS310.3017.15	3	1,5	1,7	1,57	310017L	Δ
LS310.4023.04	4	0,4	2,3	2,17	310023L	Δ
LS310.4023.05	4	0,5	2,3	2,17	310023L	Δ
LS310.4023.10	4	1	2,3	2,17	310023L	▲
LS310.4023.15	4	1,5	2,3	2,17	310023L	Δ
LS310.4023.16	4	1,6	2,3	2,17	310023L	Δ
LS310.4023.20	4	2	2,3	2,17	310023L	▲

P	●
M	●
K	●
N	○
S	●
H	-

Plaquette amovible

Inserto

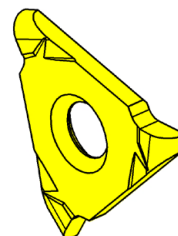
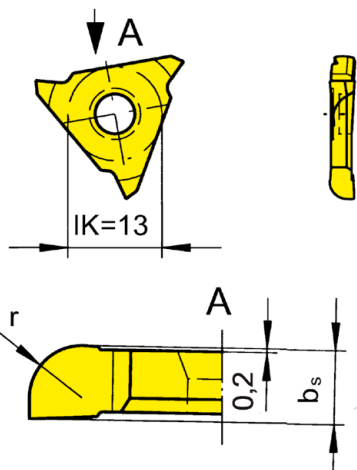
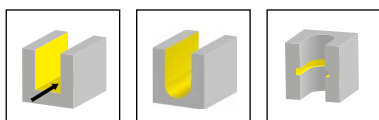

R = version à droite représentée
R = versione destra come in figura

L = version à gauche
L = versione sinistra a specchio

▲ en stock
a stock

Nuance
Leghe
Δ 4 semaines
4 settimane

N° de commande Codice prodotto	w	r	b _s	s	HIS	AS45
RS310.5028.04	5	0,4	2,68	2,62	310028R	Δ
RS310.5028.05	5	0,5	2,68	2,62	310028R	▲
RS310.5028.10	5	1	2,68	2,62	310028R	▲
RS310.5028.15	5	1,5	2,68	2,62	310028R	▲
RS310.5028.16	5	1,6	2,68	2,62	310028R	Δ
RS310.5028.20	5	2	2,68	2,62	310028R	▲
LS310.5028.04	5	0,4	2,68	2,62	310028L	Δ
LS310.5028.05	5	0,5	2,68	2,62	310028L	▲
LS310.5028.10	5	1	2,68	2,62	310028L	▲
LS310.5028.15	5	1,5	2,68	2,62	310028L	▲
LS310.5028.16	5	1,6	2,68	2,62	310028L	Δ
LS310.5028.20	5	2	2,68	2,62	310028L	▲
						P ●
						M ●
						K ●
						N o
						S ●
						H -



F

