

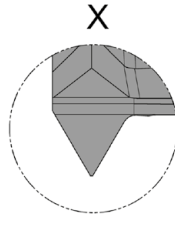

z3

60°

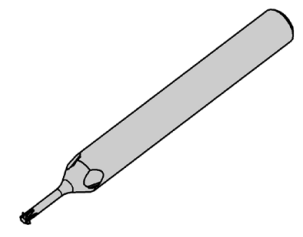
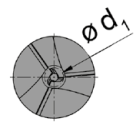
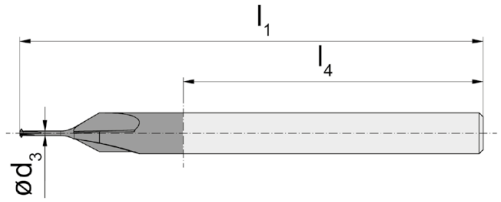

Nuance  
Leghe

▲ en stock  
a stock

Δ 4 semaines  
4 settimane

N° de commande Codice prodotto	Filetage Filettatura	D <sub>min</sub>	Z	P	d <sub>1</sub>	d <sub>2</sub>	d <sub>3</sub>	l <sub>1</sub>	l <sub>3</sub>	l <sub>4</sub>	ES15
<b>DCG.3.M1.025.2.1.03</b>	M1	0,75	3	0,25	0,7	3	0,33	34	3	22	▲
<b>DCG.3.M11.025.2.1.03</b>	M1,1	0,8	3	0,25	0,75	3	0,4	34	2,75	22	Δ
<b>DCG.3.M12.025.2.1.03</b>	M1,2	0,9	3	0,25	0,8	3	0,43	34	3	22	▲
<b>DCG.3.M14.030.2.1.03</b>	M1,4	1,1	3	0,3	1	3	0,43	34	4	22	▲
<b>DCG.3.M16.035.2.1.03</b>	M1,6	1,2	3	0,35	1,1	3	0,53	34	4	22	▲
<b>DCG.3.M2.040.2.1.03</b>	M2	1,7	3	0,4	1,5	3	0,93	34	6	22	▲
<b>DCG.3.M22.045.2.1.03</b>	M2,2	1,9	3	0,45	1,7	3	1,13	34	6	22	▲
<b>DCG.3.M25.045.2.1.03</b>	M2,5	2,2	3	0,45	2	3	1,3	34	8	22	▲
											P ●
											M o
											K ●
											N -
											S -
											H -



z3

60°

z4

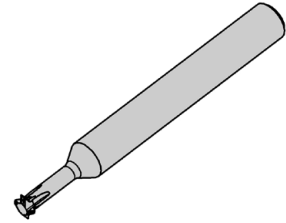
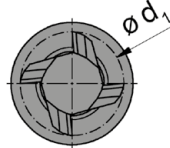
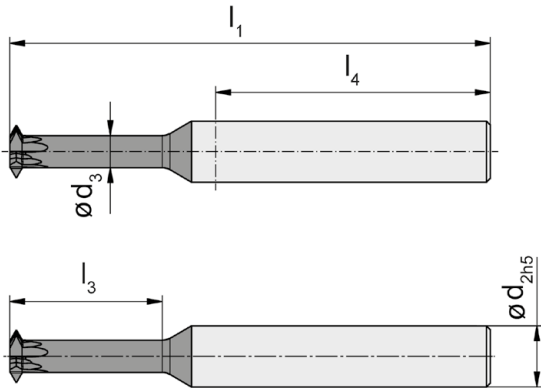
Nuance  
Leghe▲ en stock  
a stock△ 4 semaines  
4 settimane

N° de commande Codice prodotto	Filetage Filettatura	D <sub>min</sub>	Z	P	P <sub>max</sub>	d <sub>1</sub>	d <sub>2</sub>	d <sub>3</sub>	l <sub>1</sub>	l <sub>3</sub>	l <sub>4</sub>	AN25
DCG.3.M3.025.2.1.04	M3	2,4	3	0,25	0,35	2	4	1,45	39	8	22	▲
DCG.3.M3.035.2.1.04	M3	2,4	3	0,25	0,35	2	4	1,35	39	8	22	▲
DCG.3.M3.050.2.1.04	M3	2,4	3	0,5	0,5	2	4	1,2	39	8	22	▲
DCG.3.M35.050.2.1.04	M3,5	2,7	3	0,5	0,6	2,3	4	1,35	39	8	22	▲
DCG.3.M4.070.3.1.06	M4	3,3	3	0,7	0,75	2,8	6	1,7	50	10	36	▲
DCG.3.M5.050.3.1.06	M5	4,2	3	0,5	0,75	3,6	6	2,5	50	10	36	▲
DCG.3.M5.080.3.1.06	M5	4,2	3	0,8	1	3,6	6	2,2	50	10	36	▲
DCG.4.M6.100.3.1.06	M6	5	4	1	1,25	4,3	6	2,4	63	10	40	▲
DCG.4.M6.100.5.1.06	M6	5	4	1	1,25	4,3	6	2,4	63	16	40	▲
DCG.4.M8.075.5.1.08	M8-M10	6,5	4	0,75	1	5,5	8	3,85	63	16	40	▲
DCG.4.M8.075.6.1.08	M8-M10	6,5	4	0,75	1	5,5	8	3,85	63	20	36	▲
DCG.4.M8.075.7.1.08	M8-M10	6,5	4	0,75	1	5,5	8	3,85	77	25	40	▲
DCG.4.M8.125.6.1.08	M8-M10	6,5	4	1,25	1,5	5,5	8	3,4	63	20	36	▲
DCG.4.M8.125.8.1.08	M8-M10	6,5	4	1,25	1,5	5,5	8	3,4	77	30	40	▲
DCG.4.M10.150.6.1.08	M10-M12	8	4	1,5	1,75	6,8	8	4,1	63	20	36	▲
DCG.4.M10.150.8.1.08	M10-M12	8	4	1,5	1,75	6,8	8	4,1	77	30	40	▲

P	●
M	o
K	-
N	-
S	-
H	-



z3

z4

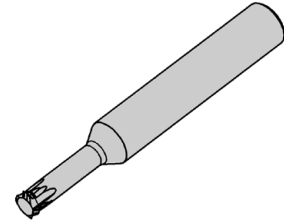
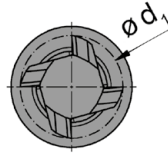
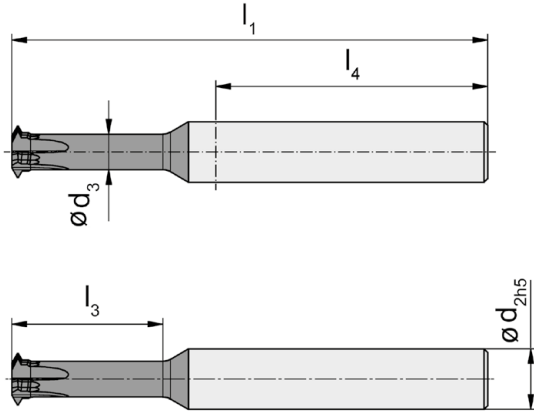

Nuance  
Leghe

▲ en stock  
a stock

△ 4 semaines  
4 settimane

N° de commande Codice prodotto	Filetage Filettatura	D <sub>min</sub>	Z	P	d <sub>1</sub>	d <sub>2</sub>	d <sub>3</sub>	l <sub>1</sub>	l <sub>3</sub>	l <sub>4</sub>	AN25
DCG.3.M3.035.2.2.04	M3	2,4	3	0,35	2	4	1,4	39	8	22	▲
DCG.3.M3.050.2.2.04	M3	2,4	3	0,5	2	4	1,25	39	8	22	▲
DCG.3.M4.070.3.2.06	M4	3,3	3	0,7	2,8	6	1,9	50	10	36	▲
DCG.3.M5.050.3.2.06	M5	4,2	3	0,5	3,6	6	2,85	50	10	36	▲
DCG.4.M6.075.5.2.06	M6	5	4	0,75	4,2	6	3,1	63	16	40	▲
DCG.4.M6.100.5.2.06	M6	5	4	1	4,2	6	2,8	63	16	40	▲
DCG.4.M8.125.5.2.08	M8	6,5	4	1,25	5,5	8	3,7	63	16	40	▲
DCG.4.M10.100.6.2.08	M10	8	4	1	6,8	8	5,4	63	20	36	▲
DCG.4.M10.100.7.2.08	M10	8	4	1	6,8	8	5,4	77	25	40	▲
DCG.4.M10.150.6.2.08	M10	8	4	1,5	6,8	8	4,7	63	20	36	▲
DCG.4.M12.100.6.2.10	M12	10	4	1	8	10	6,3	63	20	36	▲
DCG.4.M12.125.8.2.10	M12	10	4	1,25	8	10	6,1	77	30	40	▲
DCG.4.M12.175.6.2.10	M12	10	4	1,75	8	10	5,5	63	20	36	▲
DCG.4.M12.175.8.2.10	M12	10	4	1,75	8	10	5,5	77	30	40	▲

P	●
M	o
K	-
N	-
S	-
H	-

UN    z3    z4

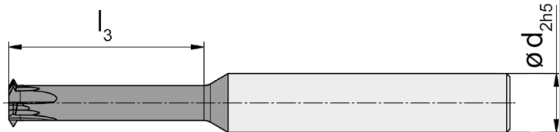
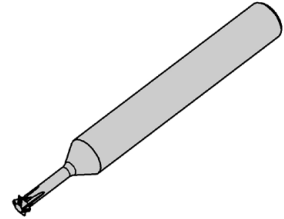
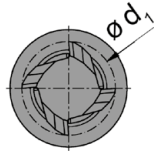
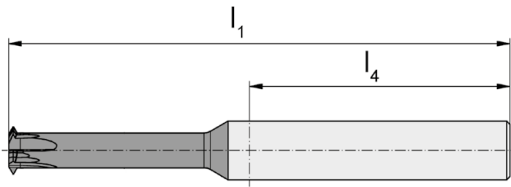

Nuance  
Leghe

▲ en stock  
a stock

Δ 4 semaines  
4 settimane

N° de commande Codice prodotto	Filetage Filettatura	D <sub>min</sub>	Z	P	d <sub>1</sub>	d <sub>2</sub>	d <sub>3</sub>	l <sub>1</sub>	l <sub>3</sub>	l <sub>4</sub>	AN25
DCG.3.60.540.2.04	#5 - 40 UNC	2,4	3	0,635	2	4	1,1	39	8	22	▲
DCG.3.60.632.2.04	#6 - 32UNC #8 - 32UNC	2,6	3	0,794	2,2	4	-	39	8	22	▲
DCG.4.60.1420.3.06	1/4" - 20 UNC	4,9	4	1,27	3,5	6	-	63	10	40	▲
DCG.4.60.1428.3.06	1/4" - 28 UNF	5,3	4	0,907	3,5	6	-	63	10	40	▲
DCG.4.60.51618.3.06	5/16" - 18 UNC	6,4	4	1,411	4,2	6	-	63	10	40	▲
DCG.4.60.3816.7.08	3/8" - 16 UNC	7,8	4	1,588	5,5	8	-	77	25	40	▲
DCG.4.60.71620.7.08	7/16" - 20 UNF	9,1	4	1,27	7,2	8	-	77	30	40	▲
DCG.4.60.1213.7.08	1/2" - 13 UNC	10,5	4	1,953	7,9	8	-	77	30	40	▲
											P ●
											M o
											K -
											N -
											S -
											H -

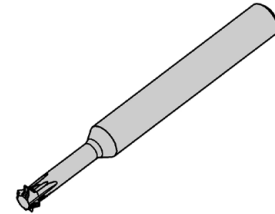
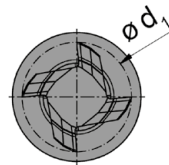
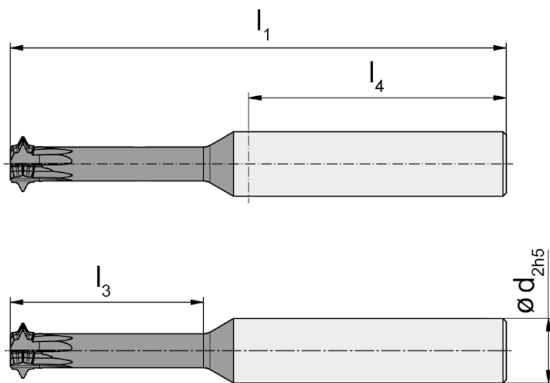
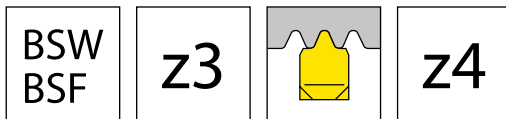

Nuance  
Leghe

▲ en stock  
a stock

Δ 4 semaines  
4 settimane

N° de commande Codice prodotto	Filetage Filettatura	D <sub>min</sub>	Z	P	d <sub>1</sub>	d <sub>2</sub>	d <sub>3</sub>	l <sub>1</sub>	l <sub>3</sub>	l <sub>4</sub>	AN25
DCG.3.55.1840.2.04	1/8" - 40 BSW	2,3	3	0,635	2	4	1	39	8	22	▲
DCG.3.55.53232.2.04	5/32" - 32 BSW	2,9	3	0,794	2,3	4	-	39	8	22	▲
DCG.3.55.31632.3.06	3/16" - 32 BSF	3,7	3	0,794	2,8	6	-	50	10	36	▲
DCG.3.55.73224.3.06	7/32" - 24 BSW	4,2	3	1,058	3,6	6	-	50	10	36	Δ
DCG.3.55.73228.3.06	7/32" - 28 BSF	4,3	3	0,907	3,6	6	-	50	10	36	▲
DCG.3.55.1420.5.06	1/4" - 20 BSW	4,7	3	1,27	4	6	-	63	16	40	▲
DCG.3.55.1426.5.06	1/4" - 26 BSF	5	3	0,977	4,2	6	-	63	16	40	▲
DCG.4.55.51618.5.06	5/16" - 18 BSW	6,1	4	1,411	5,2	6	-	63	16	40	▲
DCG.4.55.93226.5.06	9/32" - 26 BSF	5,8	4	0,977	5	6	-	63	16	40	Δ
DCG.4.55.3816.5.08	3/8" - 16 BSW	7,4	4	1,588	6,3	8	-	63	16	40	▲
DCG.4.55.3820.5.08	3/8" - 20 BSF	7,8	4	1,27	6,5	8	-	63	16	40	▲
DCG.4.55.71614.5.08	7/16" - 14 BSW	8,7	4	1,814	7,2	8	-	63	16	40	▲
DCG.4.55.71614.7.08	7/16" - 14 BSW	8,7	4	1,814	7,2	8	-	77	25	40	▲
DCG.4.55.71618.5.08	7/16" - 18 BSF	9,3	4	1,411	7,5	8	-	63	16	40	Δ
DCG.4.55.71618.7.08	7/16" - 18 BSF	9,3	4	1,411	7,5	8	-	77	25	40	Δ
DCG.4.55.1212.6.10	1/2" - 12 BSW	9,9	4	2,117	8,5	10	-	63	20	40	▲
DCG.4.55.1212.8.10	1/2" - 12 BSW	9,9	4	2,117	8,5	10	5,25	77	30	40	▲
DCG.4.55.1216.6.10	1/2" - 16 BSF	10,6	4	1,588	9,5	10	-	63	20	40	Δ

P	●
M	o
K	-
N	-
S	-
H	-

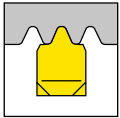

z4

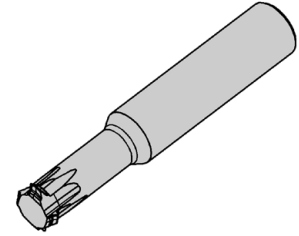
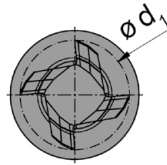
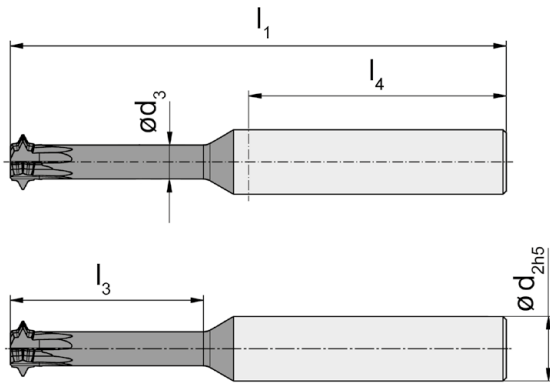
Nuance  
Leghe▲ en stock  
a stockΔ 4 semaines  
4 settimane

N° de commande Codice prodotto	Filetage Filettatura	D <sub>min</sub>	Z	P	d <sub>1</sub>	d <sub>2</sub>	d <sub>3</sub>	l <sub>1</sub>	l <sub>3</sub>	l <sub>4</sub>	AN25
<b>DCG.4.55.G18.5.08</b>	G 1/8"	8,5	4	0,91	6,6	8	5	63	16	40	▲
<b>DCG.4.55.G14.6.10</b>	G 1/4"	11,4	4	1,34	9,5	10	7,1	63	20	36	▲
<b>DCG.4.55.G38.8.10</b>	G 3/8"	14,9	4	1,34	9,8	10	7,4	77	30	40	▲
											P ●
											M ○
											K -
											N -
											S -
											H -