

S34T



Porte outils et plaquettes

Largeur de gorge 2 - 5 mm

Portainsero e inserti

Larghezza della gola 2 - 5 mm

Géométries et avances
Geometrie e avanzamenti

Page/Pag.
373

Porte outils
Portainsero
H34T

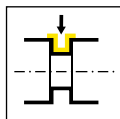

Page/Pag.
374-376

Plaque amovible
Inserto
S34T

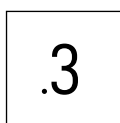

Page/Pag.
377

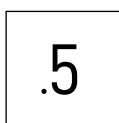

Page/Pag.
378

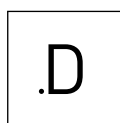

Page/Pag.
379

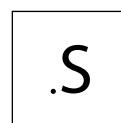

Page/Pag.
380

Plaque
Inserto
S34T

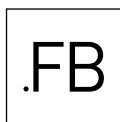

Page/Pag.
381

Géométrie Geometria	Matière Materiale	Avance f [mm/trs] Avanzamento f [mm/giro]	Usinage Lavorazione						
	<table border="0"> <tr> <td></td> <td></td> <td></td> </tr> <tr> <td></td> <td></td> <td></td> </tr> </table>							<p>↓ 0,15-0,25</p> <p>↔ 0,15-0,40</p>	
	<table border="0"> <tr> <td></td> <td></td> <td></td> </tr> <tr> <td></td> <td></td> <td></td> </tr> </table>							<p>↓ 0,10-0,45</p> <p>↔ 0,15-0,60</p>	
	<table border="0"> <tr> <td></td> <td></td> <td></td> </tr> <tr> <td></td> <td></td> <td></td> </tr> </table>							<p>↓ 0,03-0,15</p> <p>↔ 0,05-0,20</p>	
	<table border="0"> <tr> <td></td> <td></td> <td></td> </tr> <tr> <td></td> <td></td> <td></td> </tr> </table>							<p>↓ 0,02-0,08</p>	
	<table border="0"> <tr> <td></td> <td></td> <td></td> </tr> <tr> <td></td> <td></td> <td></td> </tr> </table>							<p>↓ 0,02-0,10</p> <p>↔ 0,0015-0,07</p>	

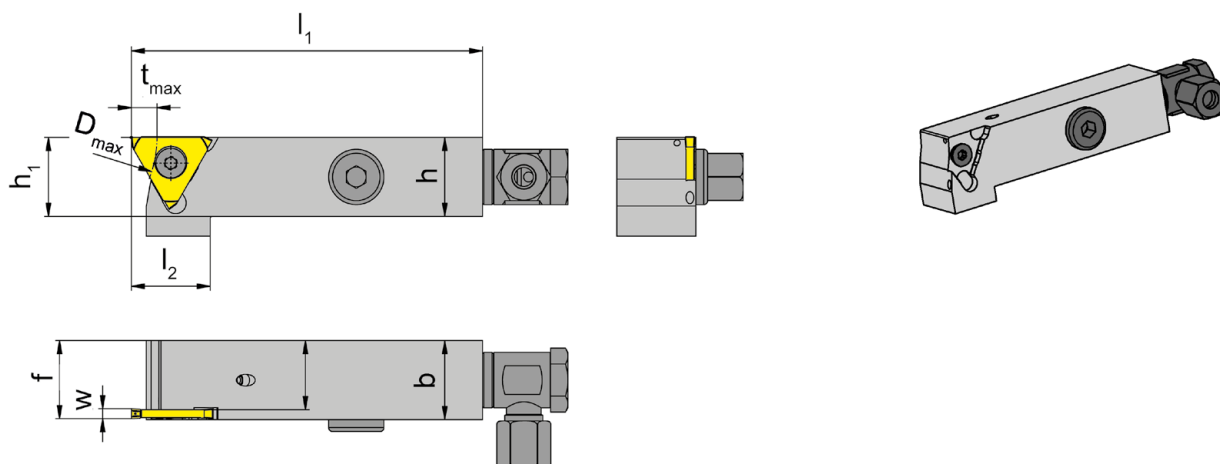
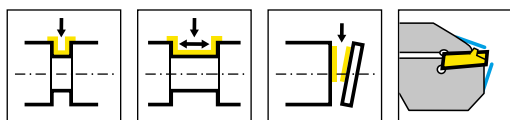

N° de commande Codice prodotto	h	b	l ₁	l ₂	h ₁	f ₁	f	D _{max}	t _{max}	HWS
RH34T.1212.6.00.IK	12	12	74	20	21	11,2	f ₁ +w-a ₁	60	6,5	34T00R
RH34T.1616.6.00.IK	16	16	74	20	21	15,2	f ₁ +w-a ₁	60	6,5	34T00R
RH34T.2020.4.00.IK	20	20	89	20	20	19,1	f ₁ +w-a ₁	60	6,5	34T00R
RH34T.2020.6.00.IK	20	20	89	20	25	19,2	f ₁ +w-a ₁	60	6,5	34T00R
LH34T.1212.6.00.IK	12	12	74	20	21	11,2	f ₁ +w-a ₁	60	6,5	34T00L
LH34T.1616.6.00.IK	16	16	74	20	21	15,2	f ₁ +w-a ₁	60	6,5	34T00L
LH34T.2020.4.00.IK	20	20	89	20	20	19,1	f ₁ +w-a ₁	60	6,5	34T00L
LH34T.2020.6.00.IK	20	20	89	20	25	19,2	f ₁ +w-a ₁	60	6,5	34T00L

Note:

...6.00.IK = Ajustement du liquide de coupe

...4.00.IK = Coolant through slotted hole VDI

Nota:

...6.00.IK = Refrigerazione attraverso innesto idraulico

...4.00.IK = Coolant through slotted hole VDI

Pièces Détachées

Ricambi

Porte outils Portainsero	Arrosage Lubrificazione	Vis de serrage Vite di serraggio	Tournevis TORX PLUS® Cacciavite TORX PLUS®	Vis Vite
R/LH34T.1212.6.00.IK	004.00.22	030.4093.T15P	T15PQ	
R/LH34T...	004.00.16	030.4093.T15P	T15PQ	004.00.26
R/LH34T.2020.4.00.IK		030.4093.T15P	T15PQ	

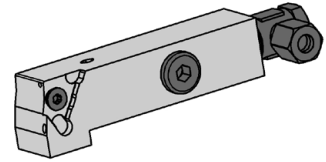
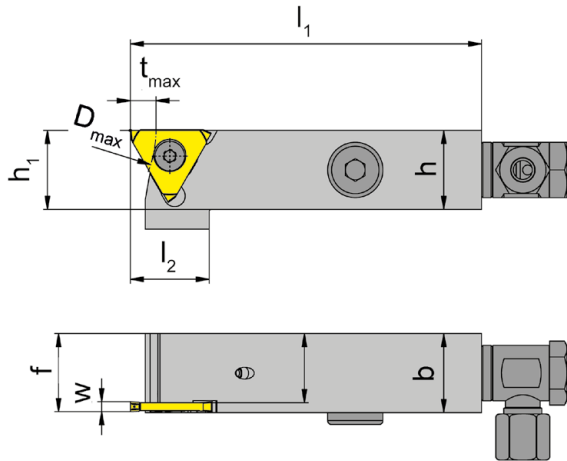
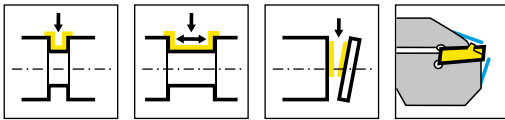

R = version à droite représentée
R = versione destra come in figura

L = version à gauche
L = versione sinistra a specchio

N° de commande Codice prodotto	h	b	l ₁	l ₂	h ₁	f ₁	f	D _{max}	t _{max}	HWS
RH34T.1212.6.10.IK	12	12	74	20	21	10,5	f ₁ +w-a ₁	60	6,5	34T01N
RH34T.1212.6.20.IK	12	12	74	20	21	11,76	f ₁ +w-a ₁	60	6,5	34T02N
RH34T.1212.6.30.IK	12	12	74	19	21	12,26	f ₁ +w-a ₁	60	6,5	34T03N
RH34T.1616.6.10.IK	16	16	74	20	21	14,5	f ₁ +w-a ₁	60	6,5	34T01N
RH34T.1616.6.20.IK	16	16	74	20	21	13,5	f ₁ +w-a ₁	60	6,5	34T02N
RH34T.1616.6.30.IK	16	16	74	19	21	12,5	f ₁ +w-a ₁	60	6,5	34T03N
RH34T.1616.6.40.IK	16	16	74	19	21	11,5	f ₁ +w-a ₁	60	6,5	34T04N
RH34T.2020.6.10.IK	20	20	89	20	25	18,5	f ₁ +w-a ₁	60	6,5	34T01N
RH34T.2020.6.20.IK	20	20	89	20	25	17,5	f ₁ +w-a ₁	60	6,5	34T02N
RH34T.2020.6.30.IK	20	20	89	19	25	16,5	f ₁ +w-a ₁	60	6,5	34T03N
RH34T.2020.6.40.IK	20	20	89	19	25	15,5	f ₁ +w-a ₁	60	6,5	34T04N
LH34T.1212.6.10.IK	12	12	74	20	21	10,5	f ₁ +w-a ₁	60	6,5	34T01N
LH34T.1212.6.20.IK	12	12	74	20	21	11,76	f ₁ +w-a ₁	60	6,5	34T02N
LH34T.1212.6.30.IK	12	12	74	19	21	12,26	f ₁ +w-a ₁	60	6,5	34T03N
LH34T.1616.6.10.IK	16	16	74	20	21	14,5	f ₁ +w-a ₁	60	6,5	34T01N
LH34T.1616.6.20.IK	16	16	74	20	21	13,5	f ₁ +w-a ₁	60	6,5	34T02N
LH34T.1616.6.30.IK	16	16	74	19	21	12,5	f ₁ +w-a ₁	60	6,5	34T03N
LH34T.1616.6.40.IK	16	16	74	19	21	11,5	f ₁ +w-a ₁	60	6,5	34T04N
LH34T.2020.6.10.IK	20	20	89	20	25	18,5	f ₁ +w-a ₁	60	6,5	34T01N
LH34T.2020.6.20.IK	20	20	89	20	25	17,5	f ₁ +w-a ₁	60	6,5	34T02N
LH34T.2020.6.30.IK	20	20	89	19	25	16,5	f ₁ +w-a ₁	60	6,5	34T03N
LH34T.2020.6.40.IK	20	20	89	19	25	15,5	f ₁ +w-a ₁	60	6,5	34T04N

w voir plaquettes amovibles
w vd. inserti

Pièces Détachées

Ricambi

Porte outils Portainsero	Arrosage Lubrificazione	Vis de serrage Vite di serraggio	Tournevis TORX PLUS® Cacciavite TORX PLUS®	Vis Vite
R/LH34T.1212.6.10.IK	004.00.22	030.4093.T15P	T15PQ	
R/LH34T.1212.6.20.IK	004.00.22	030.4010.T15P	T15PQ	
R/LH34T.1212.6.30.IK	004.00.22	030.5012.T15P	T15PQ	
R/LH34T...10/...20.IK	004.00.16	030.4093.T15P	T15PQ	004.00.26
R/LH34T.1616.6.20.IK	004.00.16	030.4010.T15P	T15PQ	004.00.26
R/LH34T...30/...40.IK	004.00.16	030.5012.T15P	T15PQ	004.00.26

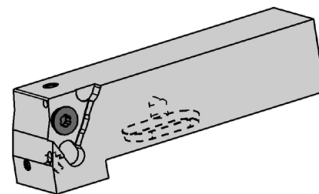
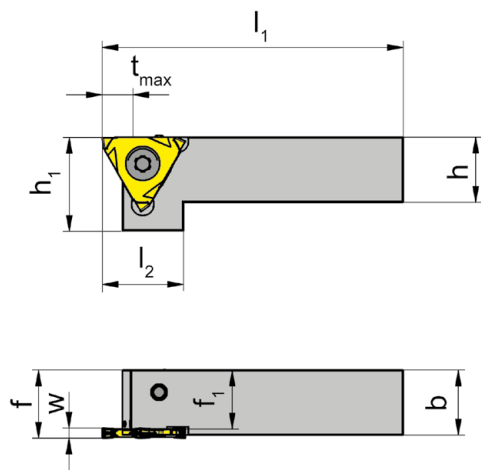
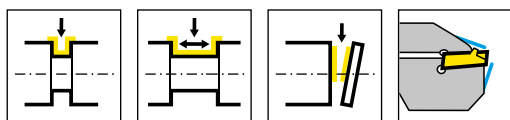

R = version à droite représentée
R = versione destra come in figura

L = version à gauche
L = versione sinistra a specchio

N° de commande Codice prodotto	h	b	l ₁	l ₂	h ₁	f ₁	f	D _{max}	t _{max}	HWS
RH34T.1616.4.10.IK	16	16	74	20	21	14,5	f ₁ +w-a ₁	60	6,5	34T01N
RH34T.1616.4.20.IK	16	16	74	20	21	13,5	f ₁ +w-a ₁	60	6,5	34T02N
RH34T.2020.4.10.IK	20	20	89	20	25	18,5	f ₁ +w-a ₁	60	6,5	34T01N
RH34T.2020.4.20.IK	20	20	89	20	25	17,5	f ₁ +w-a ₁	60	6,5	34T02N
RH34T.2020.4.30.IK	20	20	89	21	25	16,5	f ₁ +w-a ₁	60	6,5	34T03N
RH34T.2020.4.40.IK	20	20	89	21	25	15,5	f ₁ +w-a ₁	60	6,5	34T04N
RH34T.2525.4.10.IK	25	25	99	20	30	23,5	f ₁ +w-a ₁	60	6,5	34T01N
RH34T.2525.4.20.IK	25	25	99	20	30	22,5	f ₁ +w-a ₁	60	6,5	34T02N
RH34T.2525.4.30.IK	25	25	99	21	30	21,5	f ₁ +w-a ₁	60	6,5	34T03N
RH34T.2525.4.40.IK	25	25	99	21	30	20,5	f ₁ +w-a ₁	60	6,5	34T04N
LH34T.1616.4.10.IK	16	16	74	20	21	14,5	f ₁ +w-a ₁	60	6,5	34T01N
LH34T.1616.4.20.IK	16	16	74	20	21	13,5	f ₁ +w-a ₁	60	6,5	34T02N
LH34T.2020.4.00.IK	20	20	89	20	20	19,1	f ₁ +w-a ₁	60	6,5	34T00L
LH34T.2020.4.10.IK	20	20	89	20	25	18,5	f ₁ +w-a ₁	60	6,5	34T01N
LH34T.2020.4.20.IK	20	20	89	20	25	17,5	f ₁ +w-a ₁	60	6,5	34T02N
LH34T.2020.4.30.IK	20	20	89	21	25	16,5	f ₁ +w-a ₁	60	6,5	34T03N
LH34T.2020.4.40.IK	20	20	89	21	25	15,5	f ₁ +w-a ₁	60	6,5	34T04N
LH34T.2525.4.10.IK	25	25	99	20	30	23,5	f ₁ +w-a ₁	60	6,5	34T01N
LH34T.2525.4.20.IK	25	25	99	20	30	22,5	f ₁ +w-a ₁	60	6,5	34T02N
LH34T.2525.4.30.IK	25	25	99	21	30	21,5	f ₁ +w-a ₁	60	6,5	34T03N
LH34T.2525.4.40.IK	25	25	99	21	30	20,5	f ₁ +w-a ₁	60	6,5	34T04N

w voir plaquettes amovibles
w vd. inserti

Pièces Détachées

Ricambi

Porte outils Portainsero	Vis de serrage Vite di serraggio	Tournevis TORX PLUS® Cacciavite TORX PLUS®
R/LH34T...	030.4093.T15P	T15PQ
R/LH34T...20.IK	030.4010.T15P	T15PQ
R/LH34T...30.IK	030.4093.T15P	T15PQ
R/LH34T...40.IK	030.5012.T15P	T15PQ
R/LH34T.2525.4.40.IK	030.5012.T15P	T20PQ

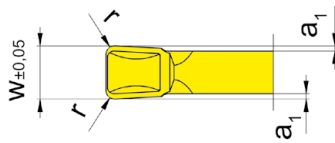
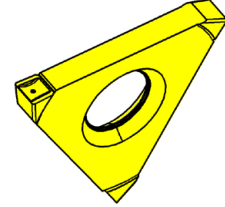
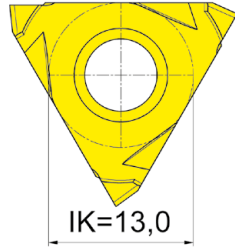
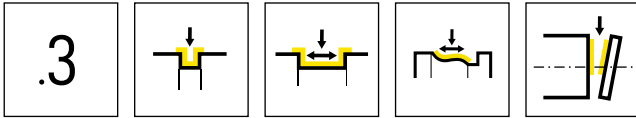

Nuance
Leghe

▲ en stock
a stock

△ 4 semaines
4 settimane

N° de commande Codice prodotto	w	r	a ₁	HIS	Nuance	
					AS45	EG55
S34T.0200.32	2	0,2	0,25	34T01N	▲	▲
S34T.0200.34	2	0,4	0,25	34T01N	▲	▲
S34T.0250.32	2,5	0,2	0,25	34T02N	△	▲
S34T.0250.34	2,5	0,4	0,25	34T02N	△	▲
S34T.0300.32	3	0,2	0,25	34T02N	△	▲
S34T.0300.34	3	0,4	0,25	34T02N	△	▲
S34T.0400.32	4	0,2	0,25	34T03N	▲	▲
S34T.0500.34	5	0,4	0,25	34T04N	▲	▲
					P	● ●
					M	● ●
					K	● ●
					N	○ -
					S	● -
					H	- -

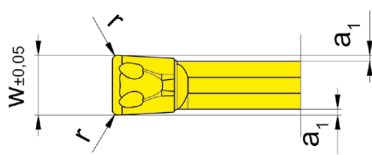
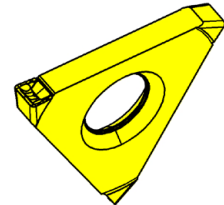
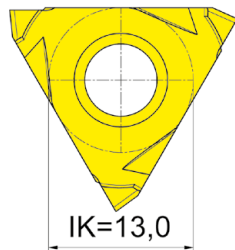
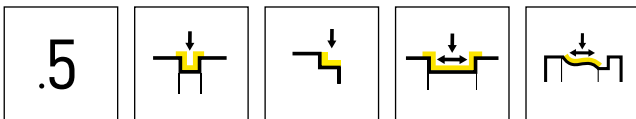

▲ en stock
a stock

△ 4 semaines
4 settimane

Nuance
Leghe

N° de commande Codice prodotto	w	r	a ₁	HIS	Nuance / Leghe	
					AS45	EG55
S34T.0250.52	2,5	0,2	0,25	34T02N	▲	
S34T.0250.54	2,5	0,4	0,25	34T02N	▲	▲
S34T.0300.52	3	0,2	0,25	34T02N	△	▲
S34T.0300.54	3	0,4	0,25	34T02N	△	▲
S34T.0400.52	4	0,2	0,25	34T03N	▲	
S34T.0400.54	4	0,4	0,25	34T03N	▲	▲
S34T.0500.54	5	0,4	0,25	34T04N		
					P	● ●
					M	● ●
					K	● ●
					N	○ -
					S	● -
					H	- -

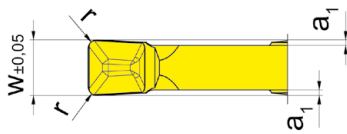
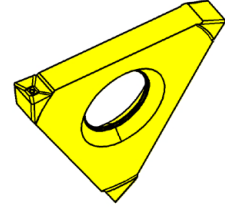
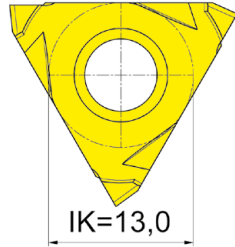
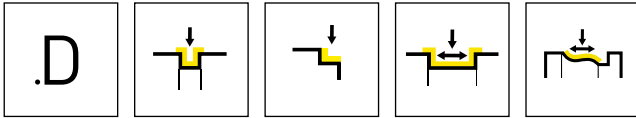

Nuance
Leghe

▲ en stock
a stock

Δ 4 semaines
4 settimane

N° de commande Codice prodotto	w	r	a ₁	HIS	Nuance	
					AS45	EG55
S34T.0200.D2	2	0,2	0,25	34T01N	▲	▲
S34T.0200.D4	2	0,4	0,25	34T01N	Δ	Δ
S34T.0250.D2	2,5	0,2	0,25	34T02N	Δ	
S34T.0250.D4	2,5	0,4	0,25	34T02N	▲	▲
S34T.0300.D2	3	0,2	0,25	34T02N	Δ	▲
S34T.0300.D4	3	0,4	0,25	34T02N	Δ	
					P	● ●
					M	● ○
					K	● ○
					N	○ -
					S	● -
					H	- -

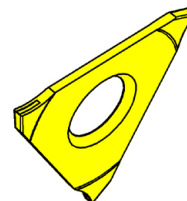
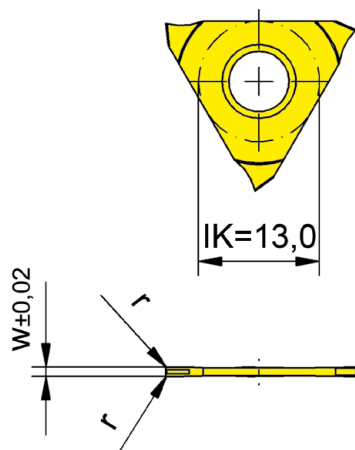
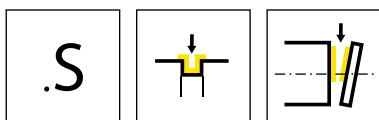

R = version à droite représentée
R = versione destra come in figura

L = version à gauche
L = versione sinistra a specchio

▲ en stock
a stock

Nuance
Leghe
Δ 4 semaines
4 settimane

N° de commande Codice prodotto	w	r	HIS	IG35
RS34T.0100.3S	1,03	0,15	34T00R	▲
LS34T.0100.3S	1,03	0,15	34T00L	▲
				P -
				M ●
				K -
				N -
				S ●
				H -

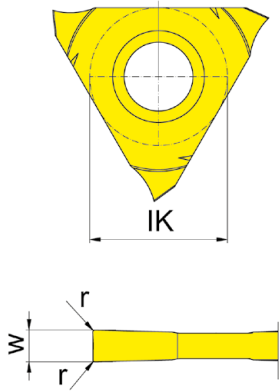
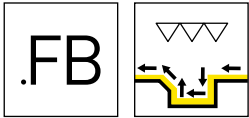

R = version à droite représentée
R = versione destra come in figura

L = version à gauche
L = versione sinistra a specchio

▲ en stock
a stock

Nuance
Leghe
Δ 4 semaines
4 settimane

N° de commande Codice prodotto	w	r	HIS	EG35
RS34T.FB10.01	1	0,1	34T00R	▲
RS34T.FB15.01	1,5	0,1	34T00R	▲
LS34T.FB10.01	1	0,1	34T00L	▲
LS34T.FB15.01	1,5	0,1	34T00L	▲

Calcul de la plus petite largeur de gorge possible w_x
Calcolo della larghezza di gola w_x più basso possibile

Exemple RS34T.FB10.01
Esempio

$$w_x = 2 \times \text{Largeur de gorge} / \text{Larghezza della gola} - 2 \times \text{Rayon d'angles plaque} / \text{Spigolo raggiato inserto} - r$$

$$w_x = 2 \times 1 \text{ mm} - 2 \times 0,1 \text{ mm}$$

$$w_x = 1,8 \text{ mm}$$

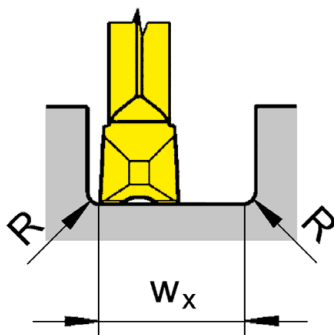

Déroulement du processus
Percorso di lavoro



P	●
M	●
K	○
N	-
S	-
H	-