

274



Porte outils et plaquettes

Largueur de gorge 0,5 - 3 mm

Portainserito e inserti

Larghezza della gola 0,5 - 3 mm

U

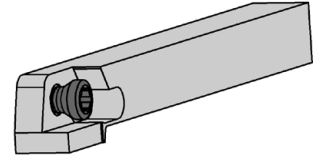
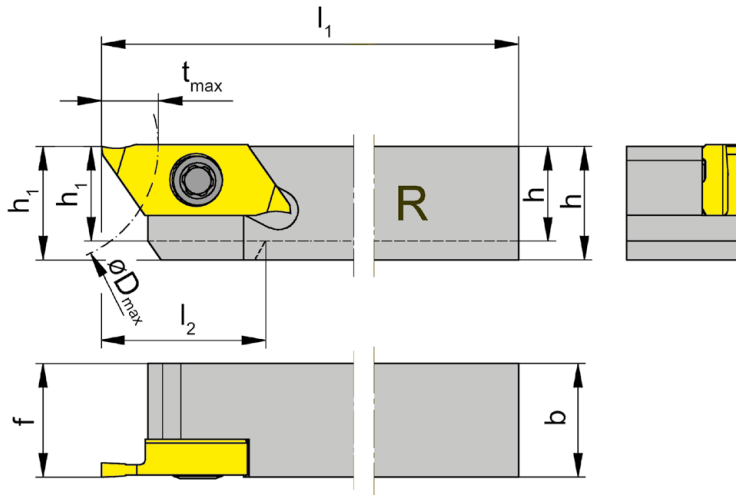
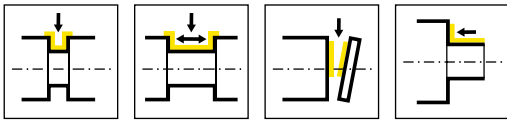

R = version à droite représentée
R = versione destra come in figura

L = version à gauche
L = versione sinistra a specchio

N° de commande Codice prodotto	h	b	l ₁	l ₂	h ₁	f	t _{max}	D _{max}	HWS
RH274.0808.04	8	8	100	16	8	8	6	25	274040R
RH274.1010.04	10	10	100	-	10	10	6	25	274040R
RH274.1212.04	12	12	100	-	12	12	6	25	274040R
RH274.1414.04	14	14	100	-	14	14	6	25	274040R
RH274.1616.04	16	16	125	-	16	16	6	25	274040R
RH274.2020.04	20	20	125	-	20	20	6	25	274040R
LH274.0808.04	8	8	100	16	8	8	6	25	274040L
LH274.1010.04	10	10	100	-	10	10	6	25	274040L
LH274.1212.04	12	12	100	-	12	12	6	25	274040L
LH274.1414.04	14	14	100	-	14	14	6	25	274040L
LH274.1616.04	16	16	125	-	16	16	6	25	274040L
LH274.2020.04	20	20	125	-	20	20	6	25	274040L

Pièces Détachées
Ricambi

Porte outils Portainsero	Vis de serrage Vite di serraggio	Tournevis TORX PLUS® Cacciavite TORX PLUS®
R/LH274.0808.04	030.350P.0744	T15PQ
R/LH274...	030.3509.T15P	T15PQ

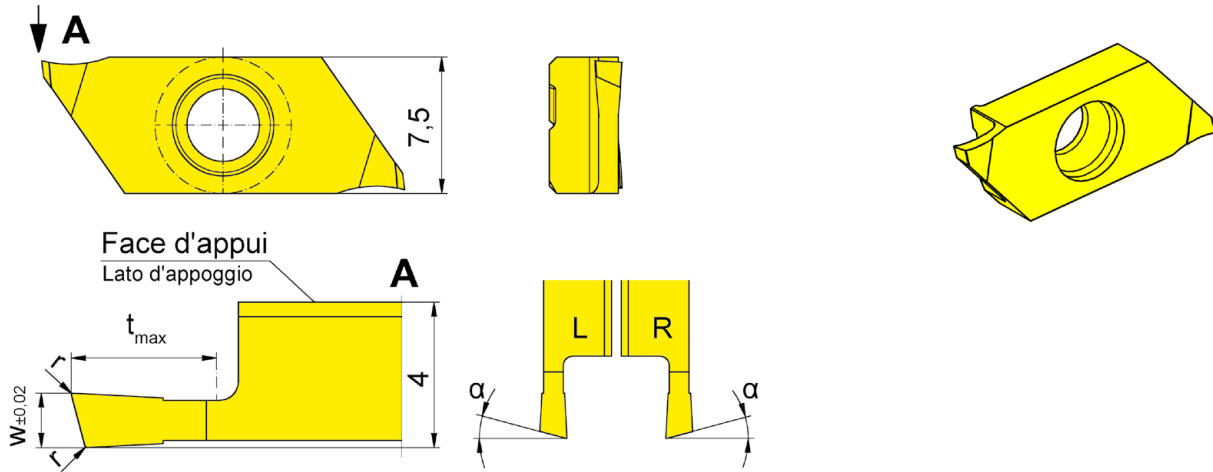
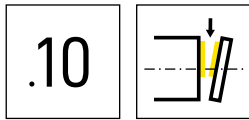

R = version à droite représentée
R = versione destra come in figura

L = version à gauche
L = versione sinistra a specchio

▲ en stock
a stock

Nuance
Leghe
Δ 4 semaines
4 settimane

N° de commande Codice prodotto	w	r	t _{max}	α	HIS	Nuance	
						IG35	TH35
RS274.1508.03.10	0,8	0,05	3	15°	274040R	▲	▲
RS274.1510.03.10	1	0,05	3	15°	274040R	▲	▲
RS274.1515.04.10	1,5	0,05	4	15°	274040R	▲	▲
RS274.1520.06.10	2	0,05	6	15°	274040R	▲	▲
LS274.1508.03.10	0,8	0,05	3	15°	274040L	▲	▲
LS274.1510.03.10	1	0,05	3	15°	274040L	▲	▲
LS274.1515.04.10	1,5	0,05	4	15°	274040L	▲	▲
LS274.1520.06.10	2	0,05	6	15°	274040L	▲	▲
						P	- ●
						M	● ●
						K	- ●
						N	- ●
						S	● ●
						H	- -

tmax 6 mm ne peut être atteint seulement avec un diamètre de pièce Ø ≤ 25 mm.
tmax 6 mm può essere raggiunta solo lavorando pezzi con diam. Ø ≤ 25 mm.





↓ A

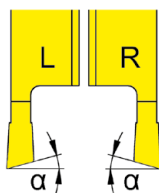
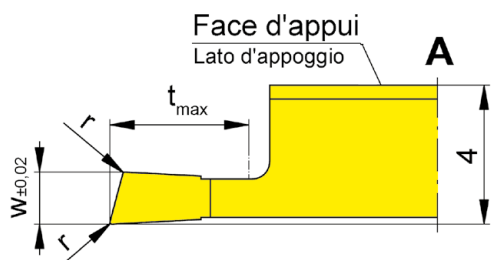
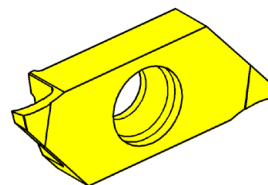
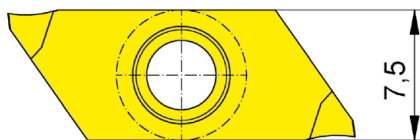

R = version à droite représentée
R = versione destra come in figura

L = version à gauche
L = versione sinistra a specchio

▲ en stock
a stock

Nuance
Leghe
Δ 4 semaines
4 settimane

N° de commande Codice prodotto	w	r	t _{max}	α	HIS	IG35	TH35
RS274.1508.03.10L	0,8	0,05	3	15°	274040R	Δ	Δ
RS274.1510.03.10L	1	0,05	3	15°	274040R	Δ	Δ
RS274.1515.04.10L	1,5	0,05	4	15°	274040R	Δ	Δ
RS274.1520.06.10L	2	0,05	6	15°	274040R	Δ	▲
LS274.1508.03.10R	0,8	0,05	3	15°	274040L	▲	▲
LS274.1510.03.10R	1	0,05	3	15°	274040L	▲	▲
LS274.1515.04.10R	1,5	0,05	4	15°	274040L	▲	▲
LS274.1520.06.10R	2	0,05	6	15°	274040L	▲	▲

tmax 6 mm ne peut être atteint seulement avec un diamètre de pièce Ø ≤ 25 mm.
tmax 6 mm può essere raggiunta solo lavorando pezzi con diam. Ø ≤ 25 mm.

P	-	●
M	●	●
K	-	●
N	-	●
S	●	●
H	-	-

U

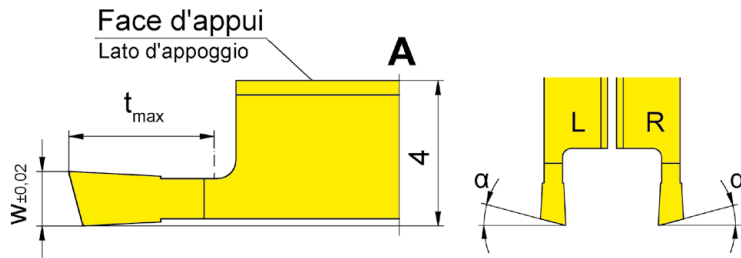
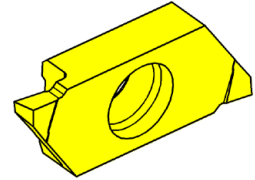
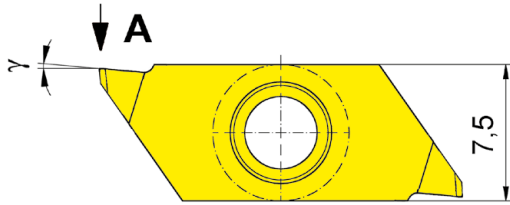
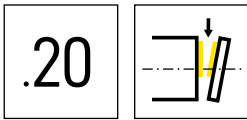

R = version à droite représentée
R = versione destra come in figura

L = version à gauche
L = versione sinistra a specchio

▲ en stock
a stock

Nuance
Leghe
Δ 4 semaines
4 settimane

N° de commande Codice prodotto	w	t _{max}	α	γ	HIS	IG35	TH35
RS274.1515.04.20	1,5	4	15°	5°	274040R	Δ	Δ
RS274.1520.06.20	2	6	15°	5°	274040R	Δ	Δ
LS274.1515.04.20	1,5	4	15°	5°	274040L	Δ	Δ
LS274.1520.06.20	2	6	15°	5°	274040L	Δ	Δ

t_{max} 6 mm ne peut être atteint seulement avec un diamètre de pièce Ø ≤ 25 mm.
t_{max} 6 mm può essere raggiunta solo lavorando pezzi con diam. Ø ≤ 25 mm.

P	-	●
M	●	●
K	-	●
N	-	●
S	●	●
H	-	-



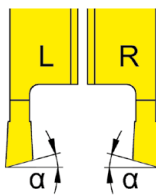
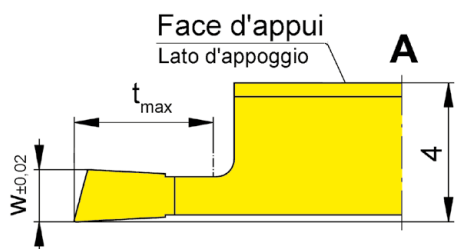
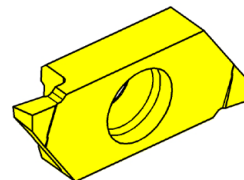
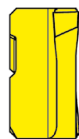
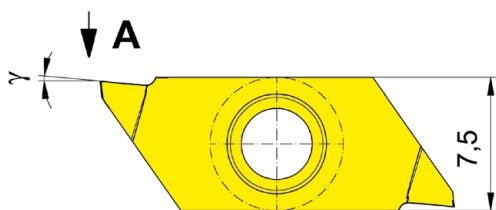

R = version à droite représentée
R = versione destra come in figura

L = version à gauche
L = versione sinistra a specchio

▲ en stock
a stock

Nuance
Leghe
Δ 4 semaines
4 settimane

N° de commande Codice prodotto	w	t _{max}	α	γ	HIS	IG35	TH35
RS274.1520.06.20L	2	6	15°	5°	274040R	Δ	Δ
LS274.1515.04.20R	1,5	4	15°	5°	274040L	Δ	Δ
LS274.1520.06.20R	2	6	15°	5°	274040L	Δ	Δ

t_{max} 6 mm ne peut être atteint seulement avec un diamètre de pièce Ø ≤ 25 mm.
t_{max} 6 mm può essere raggiunta solo lavorando pezzi con diam. Ø ≤ 25 mm.

P	-	●
M	●	●
K	-	●
N	-	●
S	●	●
H	-	-

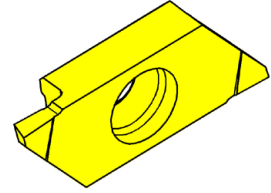
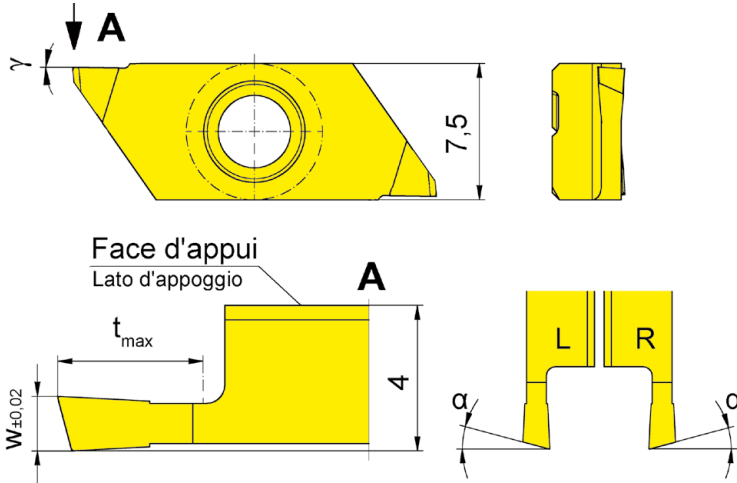
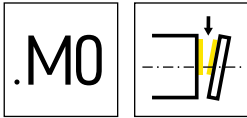

R = version à droite représentée
R = versione destra come in figura

L = version à gauche
L = versione sinistra a specchio

▲ en stock
a stock

Nuance
Leghe
Δ 4 semaines
4 settimane

N° de commande Codice prodotto	w	t _{max}	α	γ	HIS	Nuance	
						IG35	TH35
RS274.1508.03.M0	0,8	3	15°	0°	274040R	Δ	Δ
RS274.1510.03.M0	1	3	15°	0°	274040R	Δ	▲
RS274.1515.04.M0	1,5	4	15°	0°	274040R	Δ	Δ
RS274.1520.06.M0	2	6	15°	0°	274040R	Δ	Δ
LS274.1508.03.M0	0,8	3	15°	0°	274040L	Δ	Δ
LS274.1510.03.M0	1	3	15°	0°	274040L	Δ	Δ
LS274.1515.04.M0	1,5	4	15°	0°	274040L	Δ	Δ
LS274.1520.06.M0	2	6	15°	0°	274040L	Δ	Δ

t_{max} 6 mm ne peut être atteint seulement avec un diamètre de pièce Ø ≤ 25 mm.
t_{max} 6 mm può essere raggiunta solo lavorando pezzi con diam. Ø ≤ 25 mm.

P	-	●
M	●	●
K	-	●
N	-	●
S	●	●
H	-	-



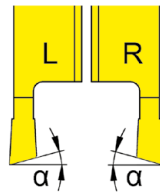
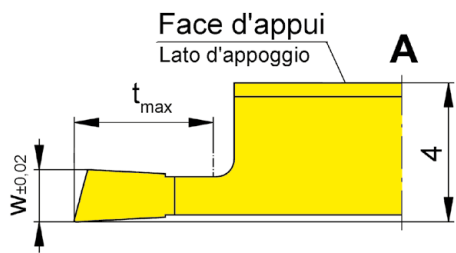
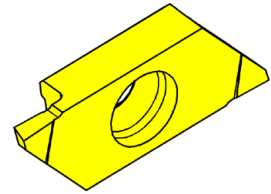
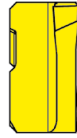
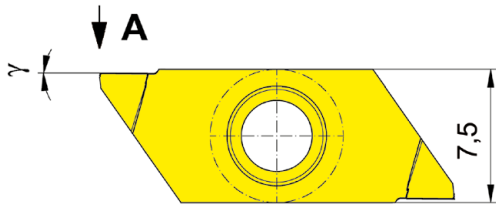
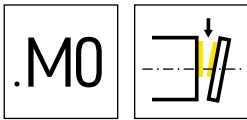

R = version à droite représentée
R = versione destra come in figura

L = version à gauche
L = versione sinistra a specchio

▲ en stock
a stock

Nuance
Leghe
Δ 4 semaines
4 settimane

N° de commande Codice prodotto	w	t _{max}	α	γ	HIS	IG35	TH35
RS274.1510.03.M0L	1	3	15°	0°	274040R	Δ	
RS274.1515.04.M0L	1,5	4	15°	0°	274040R	Δ	Δ
RS274.1520.06.M0L	2	6	15°	0°	274040R	Δ	Δ
LS274.1508.03.M0R	0,8	3	15°	0°	274040L	Δ	▲
LS274.1510.03.M0R	1	3	15°	0°	274040L	Δ	Δ
LS274.1515.04.M0R	1,5	4	15°	0°	274040L	Δ	Δ
LS274.1520.06.M0R	2	6	15°	0°	274040L	Δ	Δ

t_{max} 6 mm ne peut être atteint seulement avec un diamètre de pièce Ø ≤ 25 mm.
t_{max} 6 mm può essere raggiunta solo lavorando pezzi con diam. Ø ≤ 25 mm.

P	-	●
M	●	●
K	-	●
N	-	●
S	●	●
H	-	-

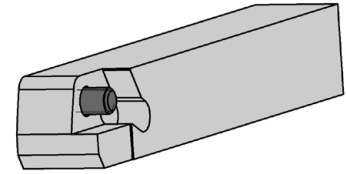
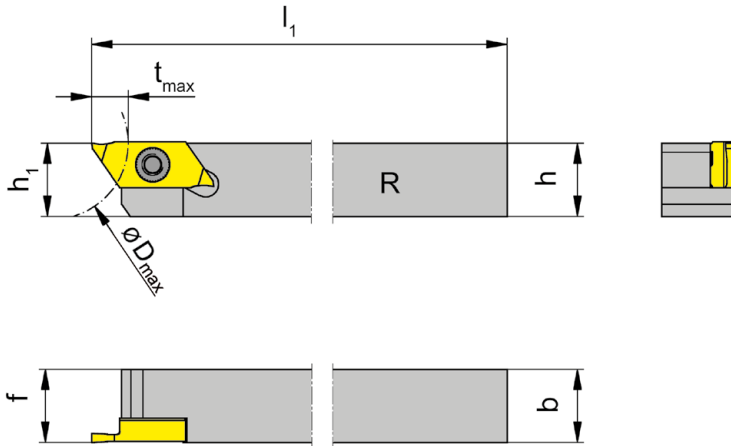
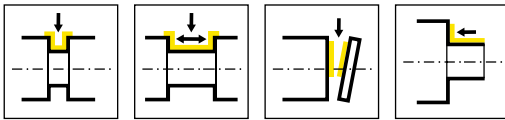

R = version à droite représentée
R = versione destra come in figura

L = version à gauche
L = versione sinistra a specchio

N° de commande Codice prodotto	h	b	l ₁	h ₁	f	t _{max}	D _{max}	HWS
RH274.1010.04.E	10	10	100	10	10	6	25	274140R
RH274.1212.04.E	12	12	100	12	12	6	25	274140R
RH274.1616.04.E	16	16	125	16	16	6	25	274140R
RH274.2020.04.E	20	20	125	20	20	6	25	274140R
LH274.1010.04.E	10	10	100	10	10	6	25	274140L
LH274.1212.04.E	12	12	100	12	12	6	25	274140L
LH274.1616.04.E	16	16	125	16	16	6	25	274140L
LH274.2020.04.E	20	20	125	20	20	6	25	274140L

Pour le couple de serrage des vis, merci de vous reporter aux Informations Techniques.
Per il corretto serraggio dinamometrico del portainsero consultare le Informazioni Tecniche.

Pièces Détachées

Ricambi

Porte outils Portainsero	Vis de serrage Vite di serraggio	Tournevis TORX PLUS® Cacciavite TORX PLUS®
R/LH274...	030.3509.T15P	T15PQ

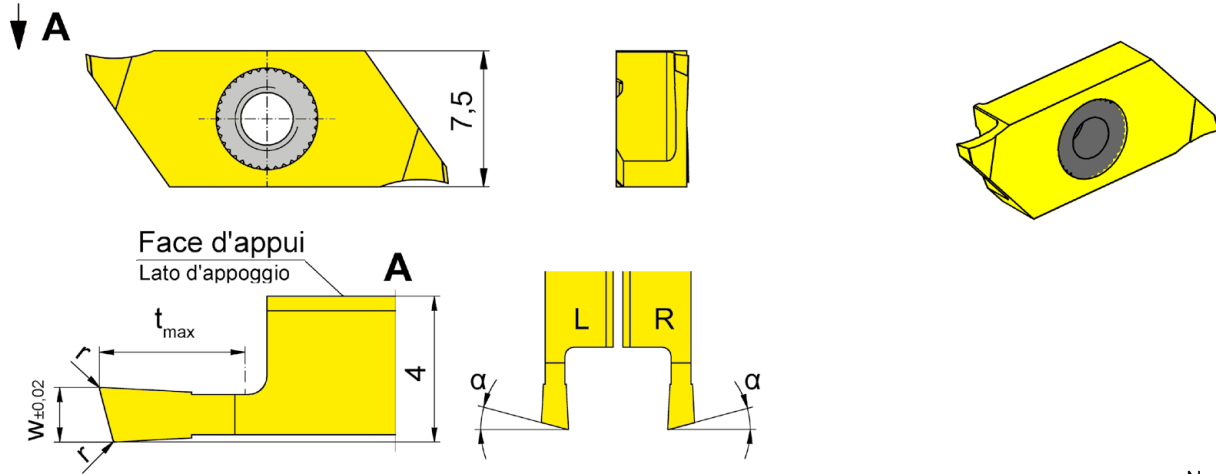
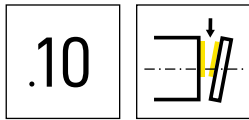

R = version à droite représentée
R = versione destra come in figura

L = version à gauche
L = versione sinistra a specchio

▲ en stock
a stock

Nuance
Leghe
Δ 4 semaines
4 settimane

N° de commande Codice prodotto	w	r	t _{max}	α	HIS	IG35	TH35
RS274.1508.03.10.E	0,8	0,05	3	15°	274140R	Δ	Δ
RS274.1510.03.10.E	1	0,05	3	15°	274140R	Δ	Δ
RS274.1515.04.10.E	1,5	0,05	4	15°	274140R	Δ	Δ
RS274.1520.06.10.E	2	0,05	6	15°	274140R	Δ	Δ
LS274.1508.03.10.E	0,8	0,05	3	15°	274140L	Δ	Δ
LS274.1510.03.10.E	1	0,05	3	15°	274140L	Δ	Δ
LS274.1515.04.10.E	1,5	0,05	4	15°	274140L	Δ	Δ
LS274.1520.06.10.E	2	0,05	6	15°	274140L	Δ	Δ

t_{max} 6 mm ne peut être atteint seulement avec un diamètre de pièce Ø ≤ 25 mm.
t_{max} 6 mm può essere raggiunta solo lavorando pezzi con diam. Ø ≤ 25 mm.

P	-	●
M	●	●
K	-	●
N	-	●
S	●	●
H	-	-

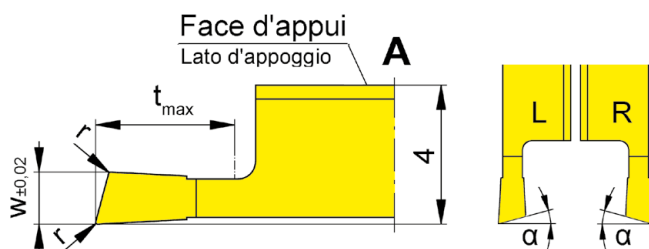
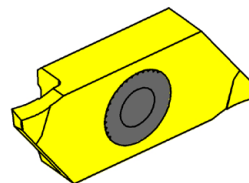
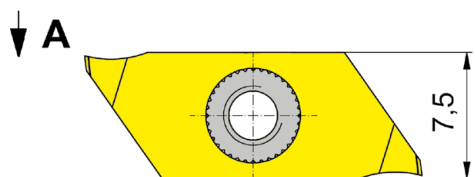
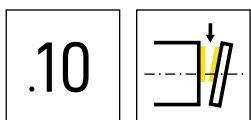

R = version à droite représentée
R = versione destra come in figura

L = version à gauche
L = versione sinistra a specchio

▲ en stock
a stock

Nuance
Leghe
Δ 4 semaines
4 settimane

N° de commande Codice prodotto	w	r	t _{max}	α	HIS	IG35	TH35
RS274.1508.03.1L.E	0,8	0,05	3	15°	274140R	Δ	Δ
RS274.1510.03.1L.E	1	0,05	3	15°	274140R	Δ	Δ
RS274.1515.04.1L.E	1,5	0,05	4	15°	274140R	Δ	Δ
RS274.1520.06.1L.E	2	0,05	6	15°	274140R	Δ	Δ
LS274.1508.03.1R.E	0,8	0,05	3	15°	274140L	Δ	Δ
LS274.1510.03.1R.E	1	0,05	3	15°	274140L	Δ	Δ
LS274.1520.06.1R.E	2	0,05	6	15°	274140L	Δ	Δ

t_{max} 6 mm ne peut être atteint seulement avec un diamètre de pièce $\varnothing \leq 25$ mm.
t_{max} 6 mm può essere raggiunta solo lavorando pezzi con diam. $\varnothing \leq 25$ mm.

P	-	●
M	●	●
K	-	●
N	-	●
S	●	●
H	-	-



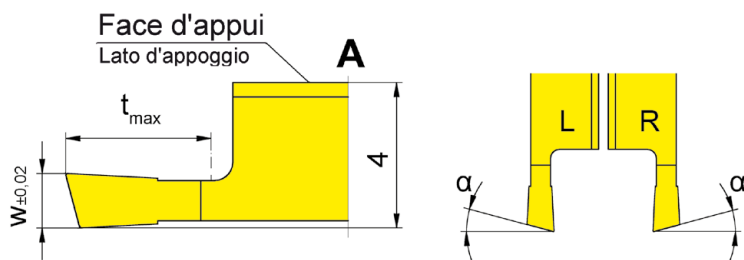
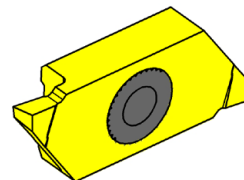
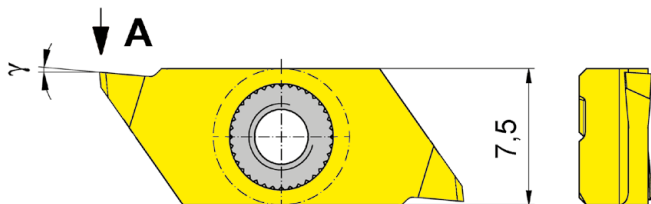

R = version à droite représentée
R = versione destra come in figura

L = version à gauche
L = versione sinistra a specchio

▲ en stock
a stock

Nuance
Leghe
Δ 4 semaines
4 settimane

N° de commande Codice prodotto	w	t _{max}	α	γ	HIS	IG35	TH35
RS274.1515.04.20.E	1,5	4	15°	5°	274140R	Δ	Δ
RS274.1520.06.20.E	2	6	15°	5°	274140R	Δ	Δ
LS274.1515.04.20.E	1,5	4	15°	5°	274140L	Δ	Δ
LS274.1520.06.20.E	2	6	15°	5°	274140L	Δ	Δ

t_{max} 6 mm ne peut être atteint seulement avec un diamètre de pièce Ø ≤ 25 mm.
t_{max} 6 mm può essere raggiunta solo lavorando pezzi con diam. Ø ≤ 25 mm.

P	-	●
M	●	●
K	-	●
N	-	●
S	●	●
H	-	-

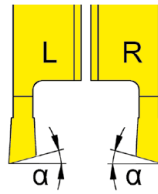
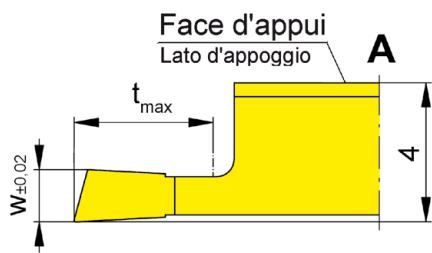
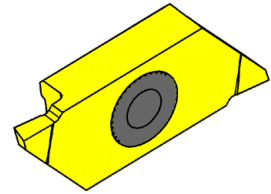
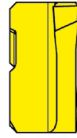
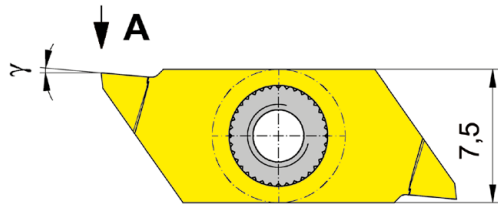
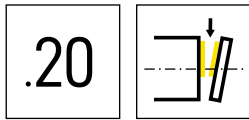

R = version à droite représentée
R = versione destra come in figura

L = version à gauche
L = versione sinistra a specchio

▲ en stock
a stock

Nuance
Leghe
Δ 4 semaines
4 settimane

N° de commande Codice prodotto	w	t _{max}	α	γ	HIS	IG35	TH35
RS274.1515.04.2L.E	1,5	4	15°	5°	274140R	Δ	Δ
RS274.1520.06.2L.E	2	6	15°	5°	274140R	Δ	Δ
LS274.1515.04.2R.E	1,5	4	15°	5°	274140L	Δ	Δ
LS274.1520.06.2R.E	2	6	15°	5°	274140L	Δ	Δ

t_{max} 6 mm ne peut être atteint seulement avec un diamètre de pièce Ø ≤ 25 mm.
t_{max} 6 mm può essere raggiunta solo lavorando pezzi con diam. Ø ≤ 25 mm.

P	-	●
M	●	●
K	-	●
N	-	●
S	●	●
H	-	-



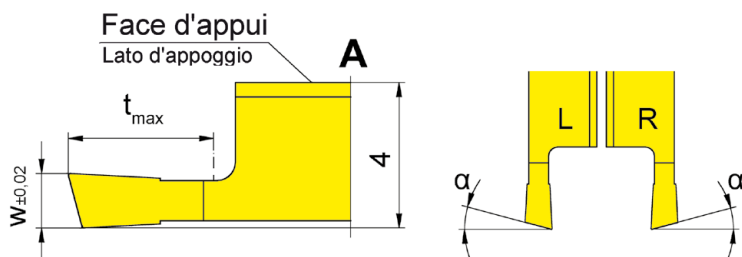
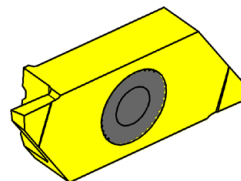
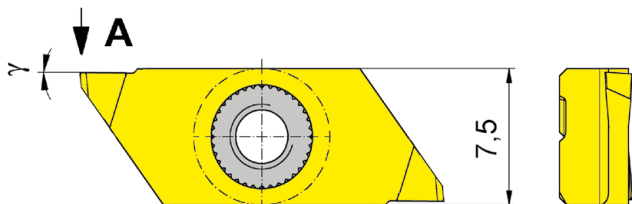
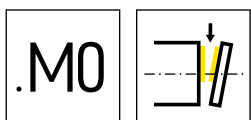

R = version à droite représentée
R = versione destra come in figura

L = version à gauche
L = versione sinistra a specchio

▲ en stock
a stock

Nuance
Leghe
Δ 4 semaines
4 settimane

N° de commande Codice prodotto	w	t _{max}	α	γ	HIS	IG35	TH35
RS274.1508.03.M0.E	0,8	3	15°	0°	274140R	Δ	Δ
RS274.1510.03.M0.E	1	3	15°	0°	274140R	Δ	Δ
RS274.1515.04.M0.E	1,5	4	15°	0°	274140R	Δ	Δ
RS274.1520.06.M0.E	2	6	15°	0°	274140R	Δ	Δ
LS274.1508.03.M0.E	0,8	3	15°	0°	274140L	Δ	Δ
LS274.1510.03.M0.E	1	3	15°	0°	274140L	Δ	Δ
LS274.1515.04.M0.E	1,5	4	15°	0°	274140L	Δ	Δ
LS274.1520.06.M0.E	2	6	15°	0°	274140L	Δ	Δ

t_{max} 6 mm ne peut être atteint seulement avec un diamètre de pièce Ø ≤ 25 mm.
t_{max} 6 mm può essere raggiunta solo lavorando pezzi con diam. Ø ≤ 25 mm.

P	-	●
M	●	●
K	-	●
N	-	●
S	●	●
H	-	-

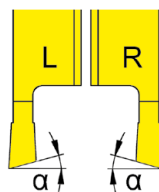
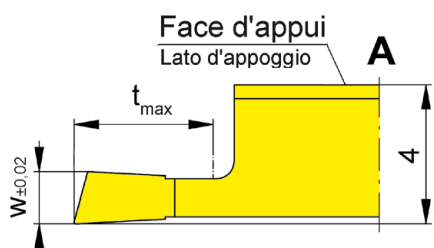
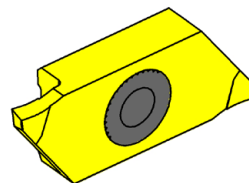
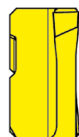
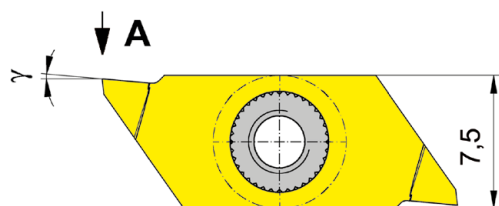
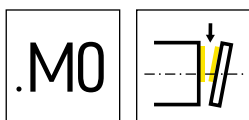

R = version à droite représentée
R = versione destra come in figura

L = version à gauche
L = versione sinistra a specchio

▲ en stock
a stock

Nuance
Leghe
Δ 4 semaines
4 settimane

N° de commande Codice prodotto	w	t _{max}	α	γ	HIS	Nuance	
						IG35	TH35
RS274.1508.03.ML.E	0,8	3	15°	0°	274140R		Δ
RS274.1510.03.ML.E	1	3	15°	0°	274140R		Δ
RS274.1515.04.ML.E	1,5	4	15°	0°	274140R		Δ
RS274.1520.06.ML.E	2	6	15°	0°	274140R		Δ
LS274.1508.03.MR.E	0,8	3	15°	0°	274140L	Δ	
LS274.1510.03.MR.E	1	3	15°	0°	274140L	Δ	Δ
LS274.1515.04.MR.E	1,5	4	15°	0°	274140L		Δ
LS274.1520.06.MR.E	2	6	15°	0°	274140L	Δ	Δ

t_{max} 6 mm ne peut être atteint seulement avec un diamètre de pièce Ø ≤ 25 mm.
t_{max} 6 mm può essere raggiunta solo lavorando pezzi con diam. Ø ≤ 25 mm.

P	-	●
M	●	●
K	-	●
N	-	●
S	●	●
H	-	-



Porte outils
Portainsero
368/391

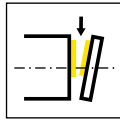

Page/Pag.
698-699

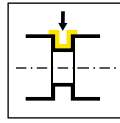

Page/Pag.
700

Plaque amovible
Inserto
312/S312

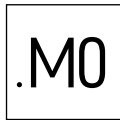

Page/Pag.
701

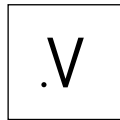

Page/Pag.
702



Page/Pag.
703

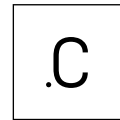

Page/Pag.
704-705



Page/Pag.
706

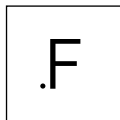

Page/Pag.
707

Informations techniques
Informazioni tecniche

Page/Pag.
713