

315

P



Porte outils et plaquettes

Largueur de gorge 0,5 - 8 mm

Portainserito e inserti

Larghezza della gola 0,5 - 8 mm

P

Géométries et avances
Geometrie e avanzamenti

Page/Pag.
429-430

Porte outils
Portainsero
356/357/333

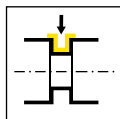

Page/Pag.
431-439

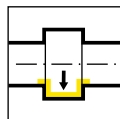

Page/Pag.
440

Cartouche
Cartuccia
357

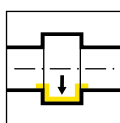

Page/Pag.
441

Dimensions de
logement
Dimensione della sede

Page/Pag.
442

Plaquette amovible
Inserto
315/S315



Page/Pag.
443-444

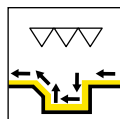

Page/Pag.
445

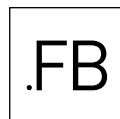

Page/Pag.
446

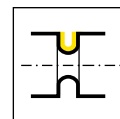

Page/Pag.
447



Page/Pag.
449



Page/Pag.
450



Page/Pag.
451

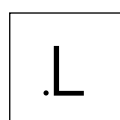

Page/Pag.
452

Dimensions de base
Dimensioni di base

Seite/Page
448

Géométrie Geometria	Matière Materiale	Avance f [mm/trs] Avanzamento f [mm/giro]	Usinage Lavorazione						
	<table border="1"> <tr> <td>P</td> <td>M</td> <td>K</td> </tr> <tr> <td>N</td> <td>S</td> <td>H</td> </tr> </table>	P	M	K	N	S	H	↓	
P	M	K							
N	S	H							
	<table border="1"> <tr> <td>P</td> <td>M</td> <td>K</td> </tr> <tr> <td>N</td> <td>S</td> <td>H</td> </tr> </table>	P	M	K	N	S	H	↓ 0,10-0,45	
P	M	K							
N	S	H							
	<table border="1"> <tr> <td>P</td> <td>M</td> <td>K</td> </tr> <tr> <td>N</td> <td>S</td> <td>H</td> </tr> </table>	P	M	K	N	S	H	↓ 0,03-0,15	
P	M	K							
N	S	H							
	<table border="1"> <tr> <td>P</td> <td>M</td> <td>K</td> </tr> <tr> <td>N</td> <td>S</td> <td>H</td> </tr> </table>	P	M	K	N	S	H	↓ 0,03-0,15	
P	M	K							
N	S	H							
	<table border="1"> <tr> <td>P</td> <td>M</td> <td>K</td> </tr> <tr> <td>N</td> <td>S</td> <td>H</td> </tr> </table>	P	M	K	N	S	H	↓ 0,10-0,22 ↔ 0,05-0,20	
P	M	K							
N	S	H							

P

P

Géométrie
Geometria

Matière
Materiale

Avance f [mm/trs]
Avanzamento f [mm/giro]

Usinage
Lavorazione

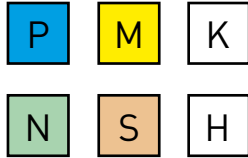
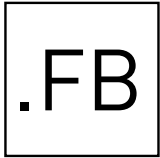

↓ 0,02-0,10
↔ 0,0015-0,07

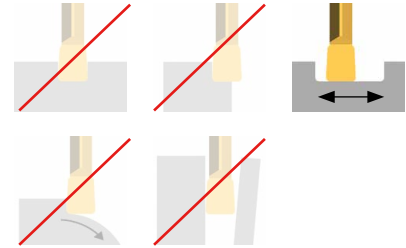

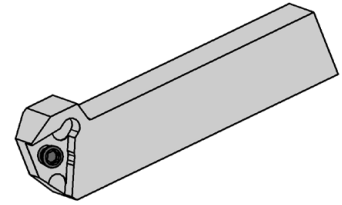
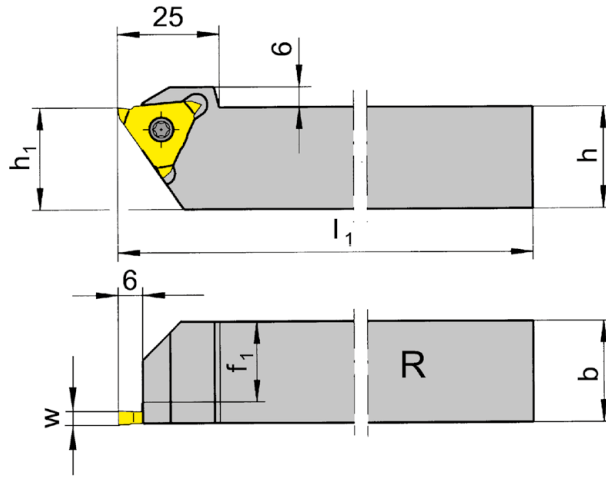
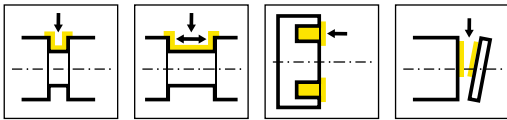

R = version à droite représentée
R = versione destra come in figura

L = version à gauche
L = versione sinistra a specchio

N° de commande Codice prodotto	h	b	l ₁	h ₁	f ₁	HWS
R356.1212.03	12	12	100	20	9	31503R
R356.1616.03	16	16	125	20	13	31503R
R356.2020.03	20	20	125	20	17	31503R
R356.2525.03	25	25	150	25	22	31503R
R356.3232.03	32	32	170	32	29	31503R
R356.1212.05	12	12	100	20	6,8	31505R
R356.1616.05	16	16	125	20	10,8	31505R
R356.2020.05	20	20	125	20	14,8	31505R
R356.2525.05	25	25	150	25	19,8	31505R
R356.3232.05	32	32	170	32	26,8	31505R
R356.2020.07	20	20	125	20	13	31507R
R356.2525.07	25	25	150	25	18	31507R
R356.3232.07	32	32	170	32	25	31507R
L356.1212.03	12	12	100	20	9	31503L
L356.1616.03	16	16	125	20	13	31503L
L356.2020.03	20	20	125	20	17	31503L
L356.2525.03	25	25	150	25	22	31503L
L356.3232.03	32	32	170	32	29	31503L
L356.1212.05	12	12	100	20	6,8	31505L
L356.1616.05	16	16	125	20	10,8	31505L
L356.2020.05	20	20	125	20	14,8	31505L
L356.2525.05	25	25	150	25	19,8	31505L
L356.3232.05	32	32	170	32	26,8	31505L
L356.2020.07	20	20	125	20	13	31507L
L356.2525.07	25	25	150	25	18	31507L
L356.3232.07	32	32	170	32	25	31507L

Pièces Détachées

Ricambi

w voir plaquettes amovibles
w vd. inserti

Porte outils Portainsero	Vis de serrage Vite di serraggio	Tournevis TORX PLUS® Cacciavite TORX PLUS®
R/L356.1212.03	5.10T20P	T20PQ
R/L356...05/...1616.03	5.12T20P	T20PQ
R/L356.1212.05	030.511P.1176	T20PQ
R/L356...07	5.15T20P	T20PQ

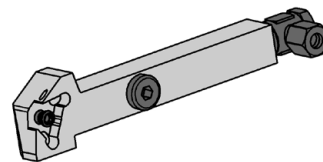
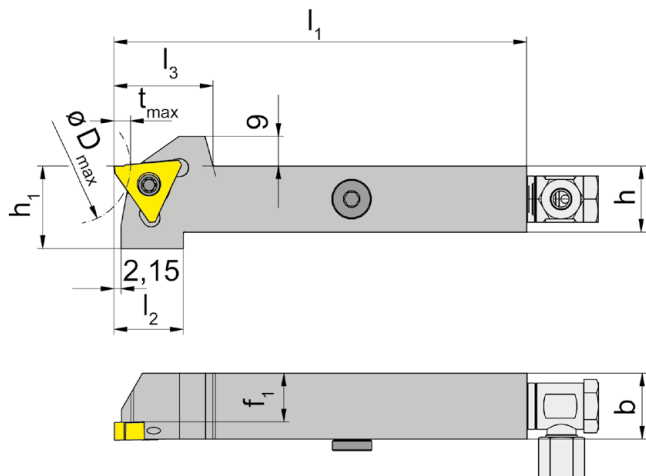
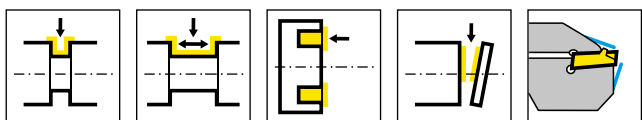

R = version à droite représentée
R = versione destra come in figura

L = version à gauche
L = versione sinistra a specchio

N° de commande Codice prodotto	h	b	l ₁	l ₂	l ₃	h ₁	f ₁	HWS
R356.1616.0.13.IK	16	16	125	22	28	21	13	31503R
R356.2020.0.13.IK	20	20	125	21	30	25	17	31503R
R356.2525.0.13.IK	25	25	150	21	30	30	22	31503R
R356.1616.0.15.IK	16	16	125	22	28	21	10,8	31505R
R356.2020.0.15.IK	20	20	125	21	30	25	14,8	31505R
R356.2525.0.15.IK	25	25	150	21	30	30	19,8	31505R
L356.1616.0.13.IK	16	16	125	22	28	21	13	31503L
L356.2020.0.13.IK	20	20	125	21	30	25	17	31503L
L356.2525.0.13.IK	25	25	150	21	30	30	22	31503L
L356.1616.0.15.IK	16	16	125	22	28	21	10,8	31505L
L356.2020.0.15.IK	20	20	125	21	30	25	14,8	31505L
L356.2525.0.15.IK	25	25	150	21	30	30	19,8	31505L

Profondeur de gorgee par rapport au ø de la pièce
Profondità gola in funzione al ø del pezzo in lavorazione

Dmax	tmax
35	5
50	4,5
75	4
125	3,5
200	3

Pièces Détachées

Ricambi

Porte outils Portainsero	Vis de serrage Vite di serraggio	Arrosage Lubrificazione	Tournevis TORX PLUS® Cacciavite TORX PLUS®	Vis Vite
R/L356...	5.12T20P	004.00.16	T20PQ	004.00.26

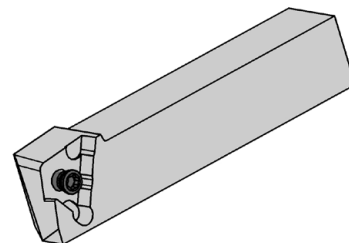
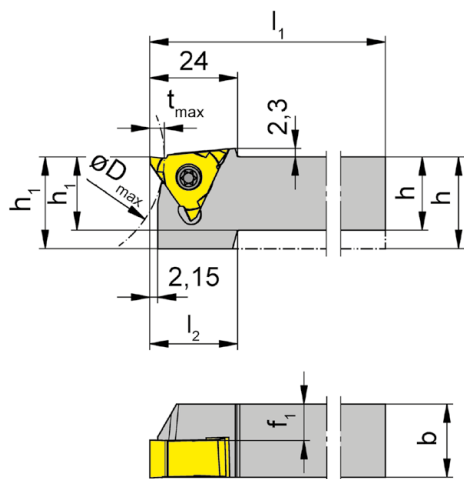
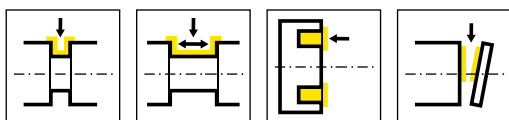

R = version à droite représentée
R = versione destra come in figura

L = version à gauche
L = versione sinistra a specchio

N° de commande Codice prodotto	h	b	l ₁	l ₂	h ₁	f ₁	HWS
R356.1616.13	16	16	125	21	20	13	31503R
R356.2020.13	20	20	125	-	20	17,1	31503R
R356.2525.13	25	25	150	-	25	22,1	31503R
R356.1616.15	16	16	125	21	20	10,8	31505R
R356.2020.15	20	20	125	21	20	14,8	31505R
R356.2525.15	25	25	150	-	25	19,8	31505R
R356.1616.16	16	16	125	-	20	10	31506R
R356.2020.16	20	20	125	21	25	14	31506R
R356.2525.16	25	25	150	-	25	19	31506R
R356.2020.17	20	20	125	21	25	13	31507R
R356.2525.17	25	25	150	-	25	18	31507R
R356.2020.10	20	20	125	21	25	10	31510R
L356.1616.13	16	16	125	21	20	13	31503L
L356.2020.13	20	20	125	-	20	17,1	31503L
L356.2525.13	25	25	150	-	25	22,1	31503L
L356.1616.15	16	16	125	21	20	10,8	31505L
L356.2020.15	20	20	125	21	20	14,8	31505L
L356.2525.15	25	25	150	-	25	19,8	31505L
L356.1616.16	16	16	125	-	20	10	31506L
L356.2020.16	20	20	125	21	25	14	31506L
L356.2525.16	25	25	150	-	25	19	31506L
L356.2020.17	20	20	125	21	25	13	31507L
L356.2525.17	25	25	150	-	25	18,1	31507L
L356.2020.10	20	20	125	21	25	10	31510L

Profondeur de gorgee par rapport au ø de la pièce
Profondità gola in funzione al ø del pezzo in lavorazione

Pièces Détachées
Ricambi

Porte outils Portainsero	Vis de serrage Vite di serraggio	Tournevis TORX PLUS® Cacciavite TORX PLUS®
R/L356...13/...15/...1616.16	5.12T20P	T20PQ
R/L356...10/...16/...17	5.15T20P	T20PQ

Dmax	tmax
35	5
50	4,5
75	4
125	3,5
200	3

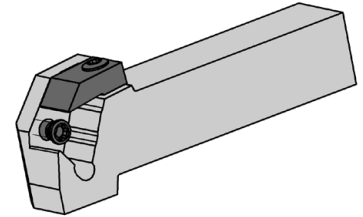
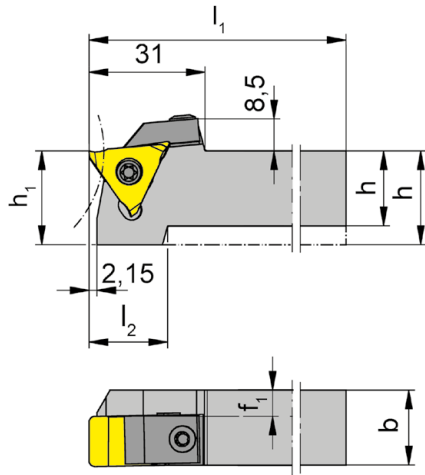
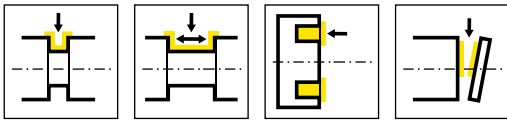

R = version à droite représentée
R = versione destra come in figura

L = version à gauche
L = versione sinistra a specchio

N° de commande Codice prodotto	h	b	l ₁	l ₂	h ₁	f ₁	HWS
R356.2020.2.13	20	20	125	21	25	7	31513R
R356.2525.2.13	25	25	150	-	25	12	31513R
L356.2020.2.13	20	20	125	21	25	7	31513L
L356.2525.2.13	25	25	150	-	25	12	31513L

Profondeur de gorgee par rapport au ø de la pièce
Profondità gola in funzione al ø del pezzo in lavorazione

Dmax	tmax
30	5
40	4,5
60	4
115	3,5
185	3

Pièces Détachées

Ricambi

Porte outils Portainsero	Vis de serrage Vite di serraggio	Bride Staffa	Tournevis TORX PLUS® Cacciavite TORX PLUS®
R/L356.2020.2.13	5.12T20P	010.2013.0468	T20PQ

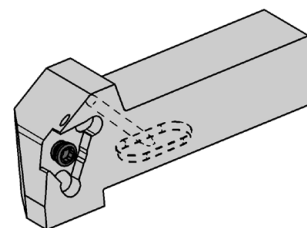
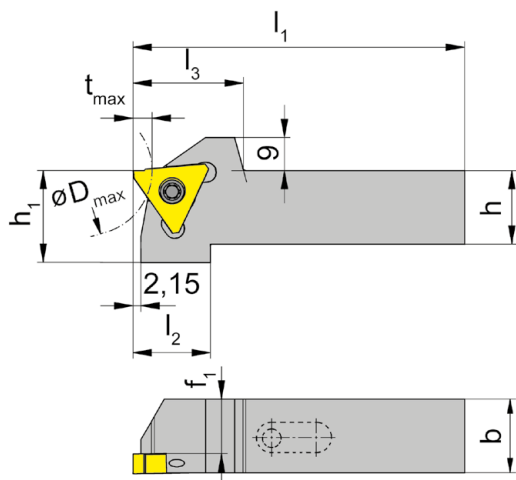
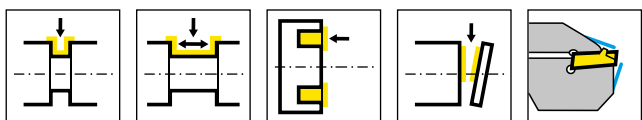

R = version à droite représentée
R = versione destra come in figura

L = version à gauche
L = versione sinistra a specchio

N° de commande Codice prodotto	h	b	l ₁	l ₂	l ₃	h ₁	f ₁	HWS
R356.1616.2.13.IK	16	16	75	22	28	21	13	31503R
R356.2020.2.13.IK	20	20	90	21	30	25	17	31503R
R356.2525.2.13.IK	25	25	105	21	30	30	22	31503R
R356.1616.2.15.IK	16	16	75	22	28	21	10,8	31505R
R356.2020.2.15.IK	20	20	90	21	30	25	14,8	31505R
R356.2525.2.15.IK	25	25	105	21	30	30	19,8	31505R
L356.1616.2.13.IK	16	16	75	22	28	21	13	31503L
L356.2020.2.13.IK	20	20	90	21	30	25	17	31503L
L356.2525.2.13.IK	25	25	105	21	30	30	22	31503L
L356.1616.2.15.IK	16	16	75	22	28	21	10,8	31505L
L356.2525.2.15.IK	25	25	105	21	30	30	19,8	31505L

w voir plaquettes amovibles
w vd. inserti

Profondeur de gorgee par rapport au ø de la pièce
Profondità gola in funzione al ø del pezzo in lavorazione

Dmax	tmax
35	5
50	4,5
75	4
125	3,5
200	3

Pièces Détachées

Ricambi

Porte outils Portainsero	Vis de serrage Vite di serraggio	Tournevis TORX PLUS® Cacciavite TORX PLUS®
R/L356...	5.12T20P	T20PQ

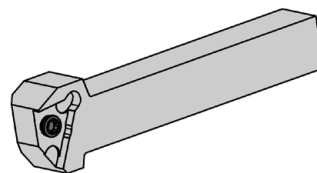
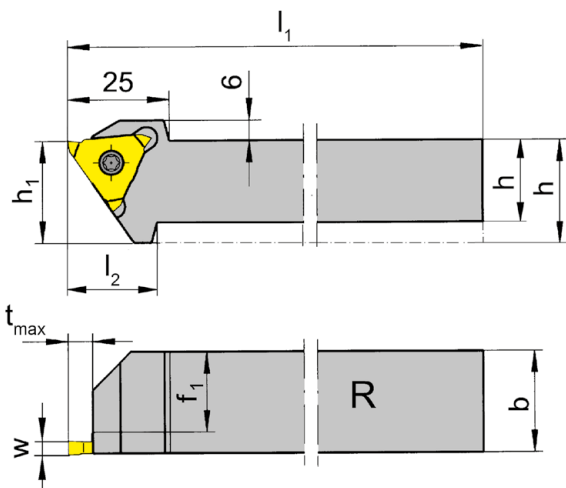
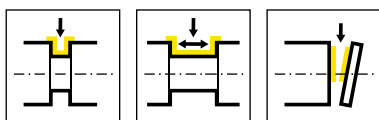

R = version à droite représentée
R = versione destra come in figura

L = version à gauche
L = versione sinistra a specchio

N° de commande Codice prodotto	h	b	l ₁	l ₂	l ₃	h ₁	f ₁	t _{max}	HWS
R356.1212.S.03	12	12	100	20	25	20	9,2	5,5	S31503R
R356.1616.S.03	16	16	125	20	25	20	13,2	5,5	S31503R
R356.2020.S.03	20	20	125	-	25	20	17,2	5,5	S31503R
R356.2525.S.03	25	25	150	-	25	25	22,2	5,5	S31503R
L356.1212.S.03	12	12	100	20	25	20	9,2	5,5	S31503L
L356.1616.S.03	16	16	125	20	25	20	13,2	5,5	S31503L
L356.2020.S.03	20	20	125	-	25	20	17,2	5,5	S31503L
L356.2525.S.03	25	25	150	-	25	25	22,2	5,5	S31503L

Pièces Détachées

Ricambi

Porte outils Portainsero	Vis de serrage Vite di serraggio	Tournevis TORX PLUS® Cacciavite TORX PLUS®
R/L356.1212.S.03	5.10T20P	T20PQ
R/L356...	5.12T20P	T20PQ

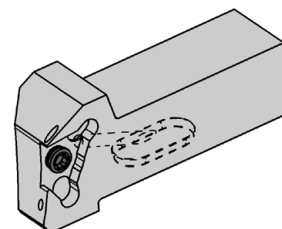
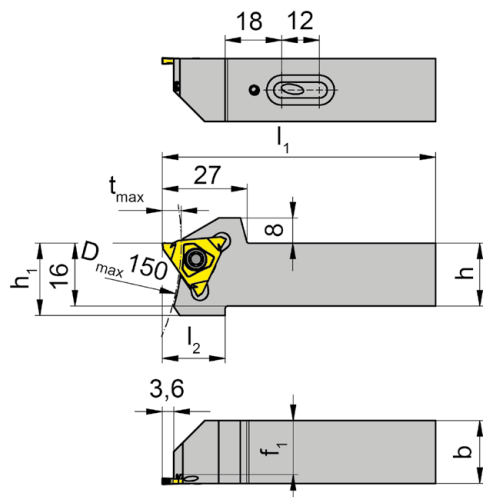
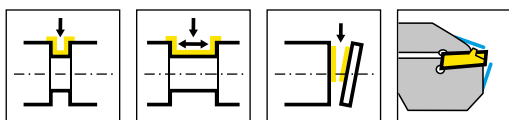

R = version à droite représentée
R = versione destra come in figura

L = version à gauche
L = versione sinistra a specchio

N° de commande Codice prodotto	h	b	l ₁	l ₂	h ₁	f ₁	t _{max}	HWS
R356.2020.S.4.03.IK	20	20	87	20	23	17,2	6	S31503R
R356.2525.S.4.03.IK	25	25	104	20	28	22,2	6	S31503R
L356.2020.S.4.03.IK	20	20	87	20	23	17,2	6	S31503L
L356.2525.S.4.03.IK	25	25	104	20	28	22,2	6	S31503L

Pièces Détachées

Ricambi

Porte outils Portainsero	Vis de serrage Vite di serraggio	Tournevis TORX PLUS® Cacciavite TORX PLUS®
R/L356...	5.12T20P	T20PQ

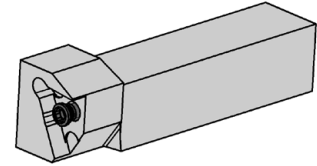
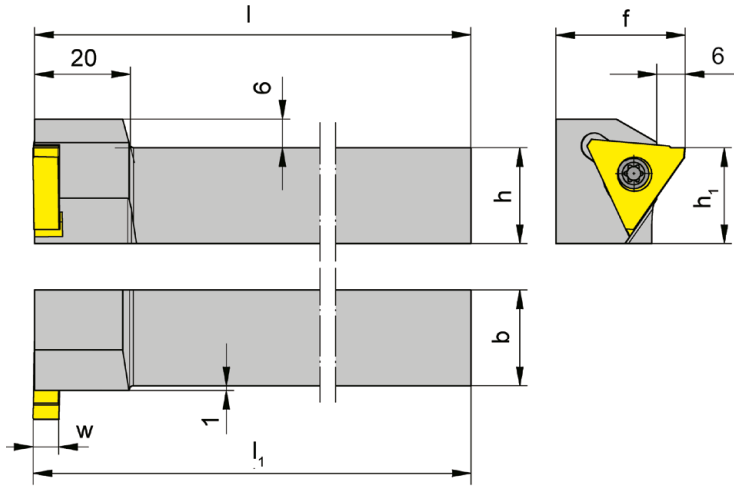
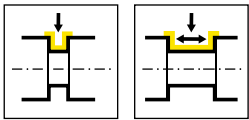

R = version à droite représentée
R = versione destra come in figura

L = version à gauche
L = versione sinistra a specchio

N° de commande Codice prodotto	h	b	l ₁	l	h ₁	f	HWS
R357.2020.05	20	20	125,3	125	20	27	31505L
R357.2525.05	25	25	150,3	150	25	32	31505L
L357.2020.05	20	20	125,3	125	20	27	31505R
L357.2525.05	25	25	150,3	150	25	32	31505R

w voir plaquettes amovibles
w vd. inserti

Pièces Détachées

Ricambi

Porte outils Portainsero	Vis de serrage Vite di serraggio	Tournevis TORX PLUS® Cacciavite TORX PLUS®
R/L357...	5.12T20P	T20PQ

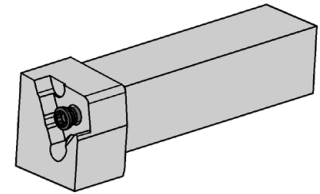
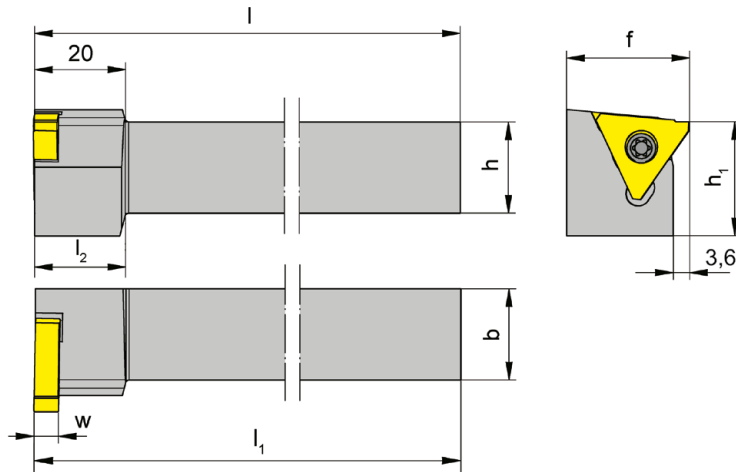
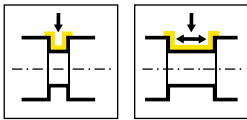

R = version à droite représentée
R = versione destra come in figura

L = version à gauche
L = versione sinistra a specchio

N° de commande Codice prodotto	h	b	l ₁	l	l ₂	h ₁	f	HWS
R357.2020.15	20	20	125,3	125	20	25	27	31505L
R357.2525.15	25	25	150,3	150	-	25	32	31505L
L357.2020.15	20	20	125,3	125	20	25	27	31505R
L357.2525.15	25	25	150,3	150	-	25	32	31505R

w voir plaquettes amovibles
w vd. inserti

Pièces Détachées

Ricambi

Porte outils Portainsero	Vis de serrage Vite di serraggio	Tournevis TORX PLUS® Cacciavite TORX PLUS®
R/L357...	5.12T20P	T20PQ

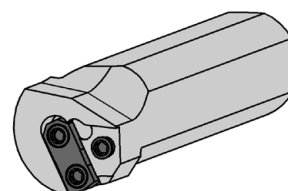
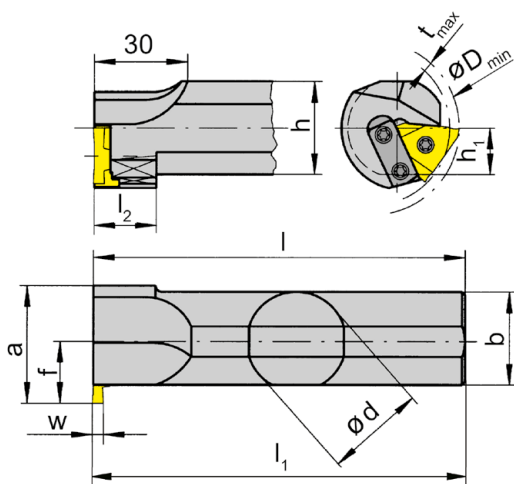
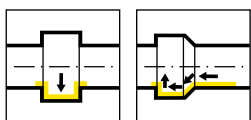

R = version à droite représentée
R = versione destra come in figura

L = version à gauche
L = versione sinistra a specchio

N° de commande Codice prodotto	d	l	l ₁	l ₂	h	a	h ₁	f	D _{min}	b	HWS
R333.0025.03	25	170	170,3	20	23	38	11,5	20	43	25	31503L
R333.0032.03	32	200	200,3	20	30	38	15	20	43	30	31503L
R333.0025.05	25	170	170,3	20	23	38	11,5	20	43	25	31505L
R333.0032.05	32	200	200,3	20	30	38	15	20	43	30	31505L
R333.0040.05	40	250	250,3	-	38	44	19	24	45	38	31505L
L333.0025.03	25	170	170,3	20	23	38	11,5	20	43	25	31503R
L333.0032.03	32	200	200,3	20	30	38	15	20	43	30	31503R
L333.0025.05	25	170	170,3	20	23	38	11,5	20	43	25	31505R
L333.0032.05	32	200	200,3	20	30	38	15	20	43	30	31505R
L333.0040.05	40	250	250,3	-	38	44	19	24	45	38	31505R

w voir plaquettes amovibles
w vd. inserti

Profondeur de gorge selon le ø d'alésage
Profondità gola in funzione al ø del foro

Dmin	tmax
43	1,8
46	2
50	3
60	4
80	4,5
100	5

Pièces Détachées

Ricambi

Porte outils Portainsero	Vis de serrage Vite di serraggio	Tournevis TORX PLUS® Cacciavite TORX PLUS®
R/L333...	5.12T20P	T20PQ

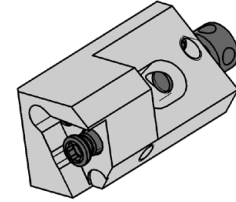
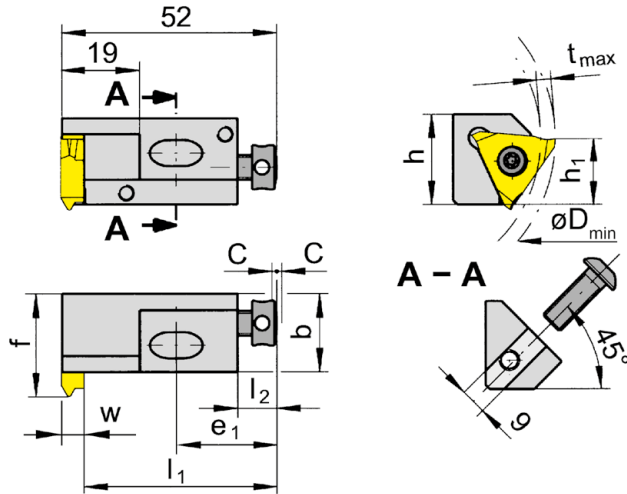
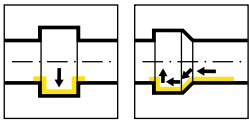

R = version à droite représentée
R = versione destra come in figura

L = version à gauche
L = versione sinistra a specchio

N° de commande Codice prodotto	h	b	h ₁	f	l ₁	E ₁	l ₂	C	HWS	HMS
R357.1619.05	21	19	16	25	46,8	24	9	2	31505L	021001R
L357.1619.05	21	19	16	25	46,8	24	9	2	31505R	021001L

w voir plaquettes amovibles
w vd. inserti

Dimensions de logement voir pages suivantes
Per dimensioni sedi vedere pagine successive

Profondeur de gorge selon le ø d'alésage
Profondità gola in funzione al ø del foro

Dmin	tmax
50	3
60	4
80	4,5
100	5

Pièces Détachées

Ricambi

Cartouche Cartuccia	Vis de serrage Vite di serraggio	Vis Vite	Tournevis TORX PLUS® Cacciavite TORX PLUS®
R/L357.1619.05	4.08.913	6.12.020	T20PQ



P

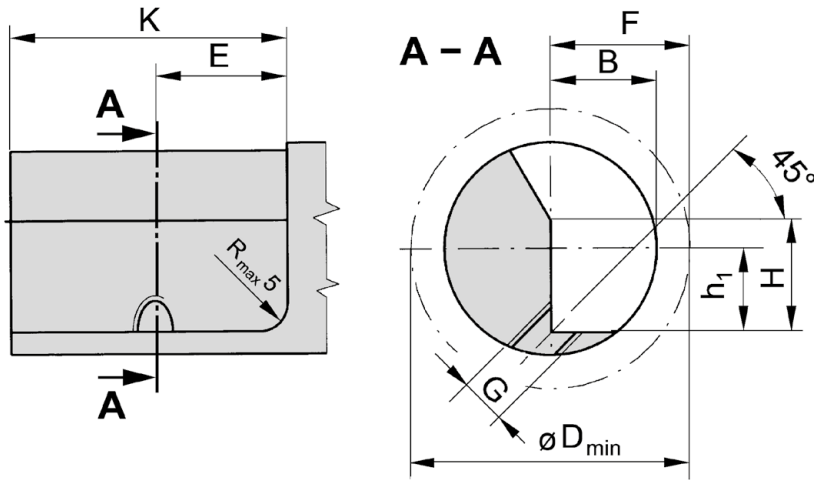

Cartouche Cartuccia	F	G	H	K	E	B	h ₁	D _{min}	HWS	HMS	Vis de fixation Vite fissaggio
R/L357.1619.05	25	M8	21	50	24	19	16	50	31505R	021001L	8.25.351

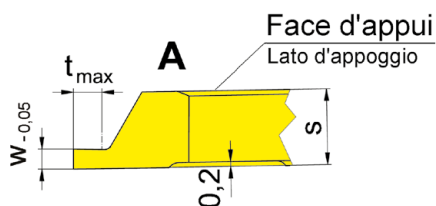
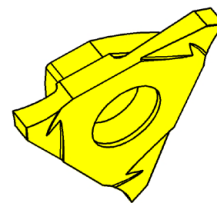
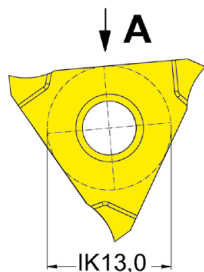
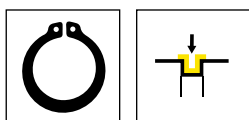

R = version à droite représentée
R = versione destra come in figura

L = version à gauche
L = versione sinistra a specchio

▲ en stock
a stock

Nuance
Leghe
Δ 4 semaines
4 settimane

N° de commande Codice prodotto	w	Nw	t _{max}	s	HIS	TN32
R315.0034.32.00	0,34	0,3	0,6	3,2	31503R	Δ
R315.0044.32.00	0,44	0,4	0,7	3,2	31503R	Δ
R315.0050.32.00	0,57	0,5	0,7	3,2	31503R	▲
R315.0060.32.00	0,67	0,6	0,8	3,2	31503R	Δ
R315.0070.32.00	0,77	0,7	1,1	3,2	31503R	▲
R315.0080.32.00	0,87	0,8	1,2	3,2	31503R	▲
R315.0090.32.00	0,97	0,9	1,4	3,2	31503R	Δ
R315.0100.32.00	1,07	1	1,6	3,2	31503R	▲
L315.0034.32.00	0,34	0,3	0,6	3,2	31503L	Δ
L315.0044.32.00	0,44	0,4	0,7	3,2	31503L	Δ
L315.0050.32.00	0,57	0,5	0,7	3,2	31503L	Δ
L315.0060.32.00	0,67	0,6	0,8	3,2	31503L	Δ
L315.0070.32.00	0,77	0,7	1,1	3,2	31503L	Δ
L315.0080.32.00	0,87	0,8	1,2	3,2	31503L	Δ
L315.0090.32.00	0,97	0,9	1,4	3,2	31503L	Δ
L315.0100.32.00	1,07	1	1,6	3,2	31503L	Δ

Usinage extér.

Plaquette à droite sur porte outil à droite 356, plaquette à gauche sur porte outil à gauche 356 utilisable

Lavorazione esterna:

356 - Montare inserto destro su portainserito destro e inserto sinistro su portainserito sinistro

P	●
M	-
K	-
N	-
S	-
H	-



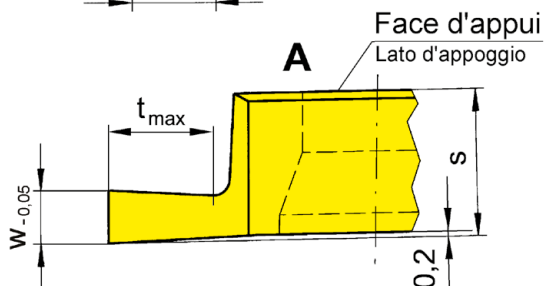
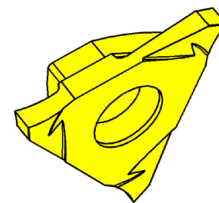
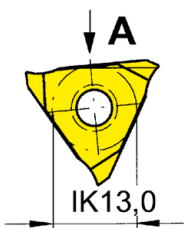
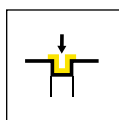

R = version à droite représentée
R = versione destra come in figura

L = version à gauche
L = versione sinistra a specchio

▲ en stock
a stock

Nuance
Leghe
Δ 4 semaines
4 settimane

N° de commande Codice prodotto	w	Nw	t _{max}	s	HIS	Nuance Leghe					
						AL96	AS42	AS46	TC92	TF45	TN35
R315.0110.00	1,24	1,1	2	5,4	31505R	Δ	Δ		Δ	▲	▲
R315.0130.00	1,44	1,3	2	5,4	31505R	Δ	Δ		Δ	▲	▲
R315.0160.00	1,74	1,6	3	5,4	31505R	Δ	Δ	Δ	Δ	Δ	▲
R315.0185.00	1,99	1,85	3	5,4	31505R		Δ		Δ	Δ	▲
R315.0215.00	2,29	2,15	4	5,4	31505R		▲		Δ	Δ	▲
R315.0265.00	2,79	2,65	4	5,4	31505R		Δ		Δ	Δ	▲
R315.0315.00	3,29	3,15	5	5,4	31505R	Δ	Δ		Δ	▲	▲
R315.0415.00	4,29	4,15	5	5,4	31505R	Δ			Δ	▲	▲
L315.0110.00	1,24	1,1	2	5,4	31505L	Δ	Δ		Δ	Δ	▲
L315.0130.00	1,44	1,3	2	5,4	31505L	Δ	Δ		Δ	▲	▲
L315.0160.00	1,74	1,6	3	5,4	31505L	Δ	Δ		Δ	Δ	▲
L315.0185.00	1,99	1,85	3	5,4	31505L	Δ			Δ	Δ	▲
L315.0215.00	2,29	2,15	4	5,4	31505L	Δ	Δ		Δ	Δ	▲
L315.0265.00	2,79	2,65	4	5,4	31505L	Δ	Δ		Δ	Δ	▲
L315.0315.00	3,29	3,15	5	5,4	31505L	Δ	Δ		Δ		▲
L315.0415.00	4,29	4,15	5	5,4	31505L		Δ		Δ		▲
L315.0515.00	5,29	5,15	5	5,4	31505L						

Usinage extér.

Plaquette à droite sur porte outil à droite 356, plaquette à gauche sur porte outil à gauche 356 utilisable

Lavorazione esterna:

356 - Montare inserto destro su portainserito destro e inserto sinistro su portainserito sinistro

Usinage intér.

Plaquette à droite sur porte outil à gauche 333/357, plaquette à gauche sur porte outil à droite 333/357 utilisable

Lavorazione interna:

333/357 - Montare inserto destro su portainserito sinistro, inserto sinistro su portainserito destro.

P	●	●	○	●	●	●
M	-	●	○	-	●	●
K	●	●	●	-	●	●
N	●	●	○	-	●	●
S	-	●	○	-	●	●
H	-	-	-	-	-	-

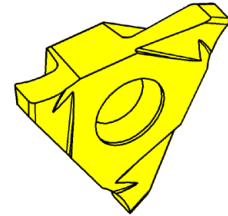
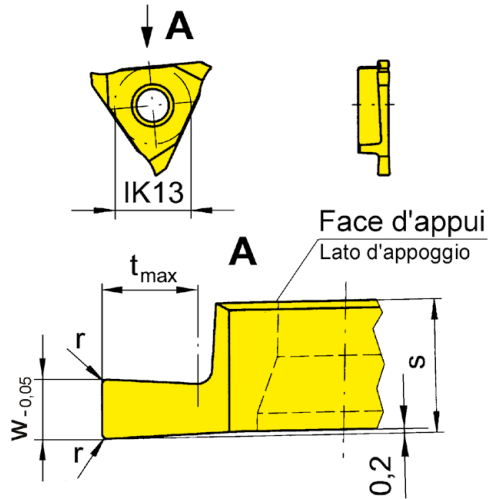
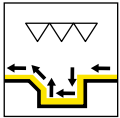

R = version à droite représentée
R = versione destra come in figura

L = version à gauche
L = versione sinistra a specchio

Nuance
Leghe
▲ en stock
a stock
Δ 4 semaines
4 settimane

N° de commande Codice prodotto	w	r	t _{max}	s	HIS	AL96	AS42	AS45	AS46	TC92	TF45	TN35
R315.0200.02	2	0,2	3	5,4	31505R	Δ	▲		Δ	Δ	Δ	▲
R315.0200.04	2	0,4	3	5,4	31505R	Δ	Δ			Δ	Δ	▲
R315.0300.02	3	0,2	4	5,4	31505R	Δ	▲			Δ	Δ	▲
R315.0300.04	3	0,4	4	5,4	31505R	Δ	Δ		Δ	Δ	Δ	▲
R315.0400.02	4	0,2	5	5,4	31505R		Δ					Δ
R315.0400.04	4	0,4	5	5,4	31505R		Δ					▲
R315.0500.02	5	0,2	5	5,4	31505R			Δ				
R315.0600.04	6	0,4	5	6,4	31506R			Δ				
R315.0800.04	8	0,4	5	8,4	31507R			Δ				
L315.0200.02	2	0,2	3	5,4	31505L	Δ	▲			Δ	Δ	▲
L315.0200.04	2	0,4	3	5,4	31505L	Δ	Δ			Δ	Δ	Δ
L315.0300.02	3	0,2	4	5,4	31505L	Δ	Δ			Δ	Δ	▲
L315.0300.04	3	0,4	4	5,4	31505L	Δ	Δ			Δ	Δ	▲
L315.0400.02	4	0,2	5	5,4	31505L		Δ					▲
L315.0400.04	4	0,4	5	5,4	31505L		Δ					▲
L315.0500.02	5	0,2	5	5,4	31505L			Δ				
L315.0600.04	6	0,4	5	6,4	31506L			▲				
L315.0800.04	8	0,4	5	8,4	31507L							

Usinage extér.

Plaquette à droite sur porte outil à droite 356, plaquette à gauche sur porte outil à gauche 356 utilisable

Lavorazione esterna:

356 - Montare inserto destro su portainsero destro e inserto sinistro su portainsero sinistro

Usinage intér.

Plaquette à droite sur porte outil à gauche 333/357, plaquette à gauche sur porte outil à droite 333/357 utilisable

Lavorazione interna:

333/357 - Montare inserto destro su portainsero sinistro, inserto sinistro su portainsero destro.

P	●	●	●	○	●	●	●
M	-	●	●	○	-	●	●
K	●	●	●	●	-	●	●
N	●	●	○	○	-	●	●
S	-	●	●	○	-	●	●
H	-	-	-	-	-	-	-



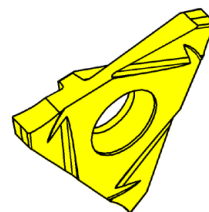
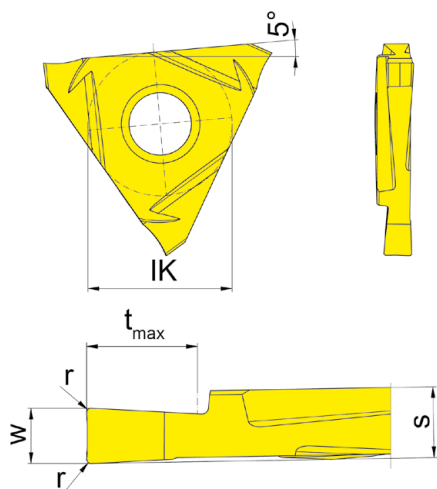
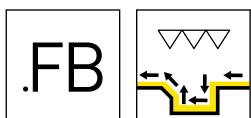

R = version à droite représentée
R = versione destra come in figura

L = version à gauche
L = versione sinistra a specchio

▲ en stock
a stock

Nuance
Leghe
Δ 4 semaines
4 settimane

N° de commande Codice prodotto	w	r	t _{max}	s	HIS	H20
R315.FB25.02	2,5	0,2	5	3,2	31503R	▲
R315.FB30.02	3	0,2	5	3,2	31503R	▲
L315.FB25.02	2,5	0,2	5	3,2	31503L	▲
L315.FB30.02	3	0,2	5	3,2	31503L	▲

Calcul de la plus petite largeur de gorge w_x
Calcolo della larghezza di gola w_x più basso possibile

Exemple R315.FB30.02
Esempio

$w_x = 2 \times$ Largeur de gorge / Larghezza della gola $w - 2 \times$ Rayon d'angles plaque / Spigolo raggiato inserto r

$w_x = 2 \times 3 \text{ mm} - 2 \times 0,2 \text{ mm}$

$w_x = 5,6 \text{ mm}$

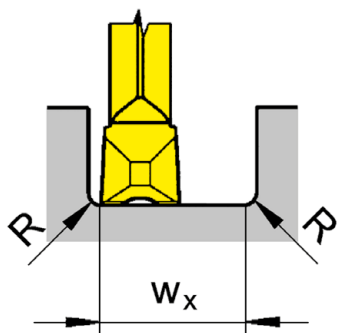

Déroutement du processus
Percorso di lavoro

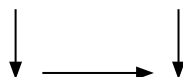

P	●
M	○
K	-
N	-
S	-
H	-

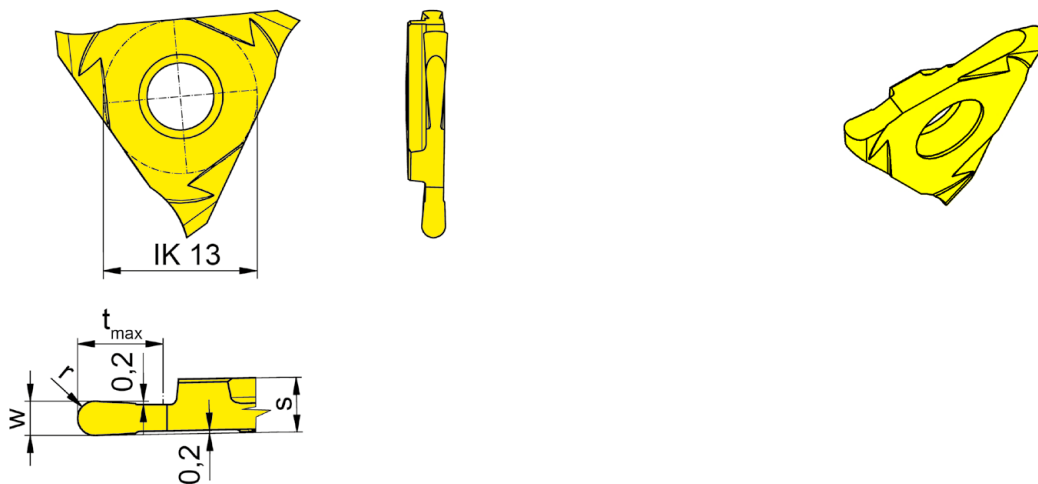
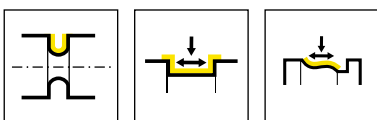

R = version à droite représentée
R = versione destra come in figura

L = version à gauche
L = versione sinistra a specchio

▲ en stock
a stock

Nuance
Leghe
Δ 4 semaines
4 settimane

N° de commande Codice prodotto	w	t _{max}	r	s	HIS	AS45
R315.0100.05	1	2,5	0,5	3,2	31503R	▲
R315.0120.06	1,2	3	0,6	3,2	31503R	▲
R315.0150.07	1,5	5	0,75	3,2	31503R	▲
R315.0160.08	1,6	5	0,8	3,2	31503R	▲
R315.0180.09	1,8	5	0,9	3,2	31503R	Δ
R315.0200.10	2	5	1	3,2	31503R	▲
R315.0220.11	2,2	5	1,1	3,2	31503R	Δ
R315.0250.12	2,5	5	1,25	3,2	31503R	▲
R315.0280.14	2,8	5	1,4	3,2	31503R	▲
R315.0300.15	3	5	1,5	3,2	31503R	▲
R315.0360.18	3,6	5	1,8	5,4	31505R	Δ
R315.0400.20	4	5	2	5,4	31505R	Δ
L315.0100.05	1	2,5	0,5	3,2	31503L	▲
L315.0120.06	1,2	3	0,6	3,2	31503L	▲
L315.0150.07	1,5	5	0,75	3,2	31503L	▲
L315.0160.08	1,6	5	0,8	3,2	31503L	Δ
L315.0180.09	1,8	5	0,9	3,2	31503L	Δ
L315.0200.10	2	5	1	3,2	31503L	▲
L315.0220.11	2,2	5	1,1	3,2	31503L	Δ
L315.0250.12	2,5	5	1,25	3,2	31503L	▲
L315.0280.14	2,8	5	1,4	3,2	31503L	Δ
L315.0300.15	3	5	1,5	3,2	31503L	Δ
L315.0360.18	3,6	5	1,8	5,4	31505L	Δ
L315.0400.20	4	5	2	5,4	31505L	Δ

Usage extér.

Plaquette à droite sur porte outil à droite 356, plaquette à gauche sur porte outil à gauche 356 utilisable

Lavorazione esterna:

356 - Montare inserto destro su portainserito destro e inserto sinistro su portainserito sinistro

Usage intér.

Plaquette à droite sur porte outil à gauche 333/357, plaquette à gauche sur porte outil à droite 333/357 utilisable

Lavorazione interna:

333/357 - Montare inserto destro su portainserito sinistro, inserto sinistro su portainserito destro.

Largeur de gorge supérieur à 1,6 mm uniquement recommandé pour de la gorge
Larghezza gola fino a 1,6 mm consigliata solo in esecuzione gole

P	●
M	●
K	●
N	○
S	●
H	-



P

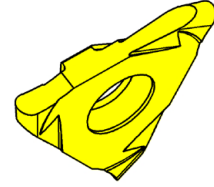
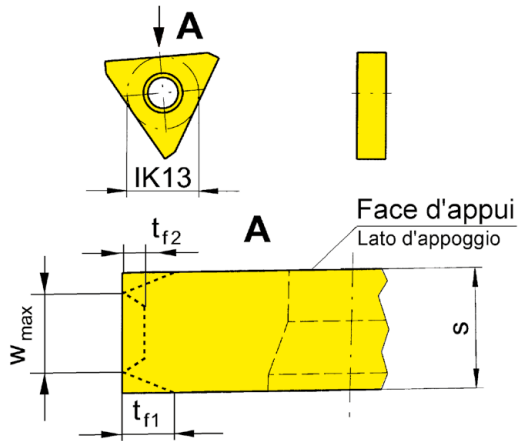

R = version à droite représentée
R = versione destra come in figura

L = version à gauche
L = versione sinistra a specchio

▲ en stock
ou stock

▲ Nuance
Leghe

Δ 4 semaines
4 settimane

N° de commande Codice prodotto	W_{max}	t_{f1}	t_{f2}	s	EG35	TN35	TI25	TA45	TA46
R/L315...	3,05	5	-	3,25					
R/L315...	5,25	5	2	5,45					
R/L315...	5,9	5	2	6,1					
R/L315...	6,4	5	2	6,6					
R/L315...	6,9	5	2	7,1					
R/L315...	7,3	5	2	7,5					
R/L315...	8,3	5	2	8,5					
R/L315...	9,3	5	2	9,5					
R/L315...	10,3	5	2	10,5					
R/L315...	13,3	5	2	13,5					
R/L315...	15,3	5	2	15,5					
					SUR DEMANDE SU RICHIESTA				
					P				
					M				
					K				
					N				
					S				
					H				

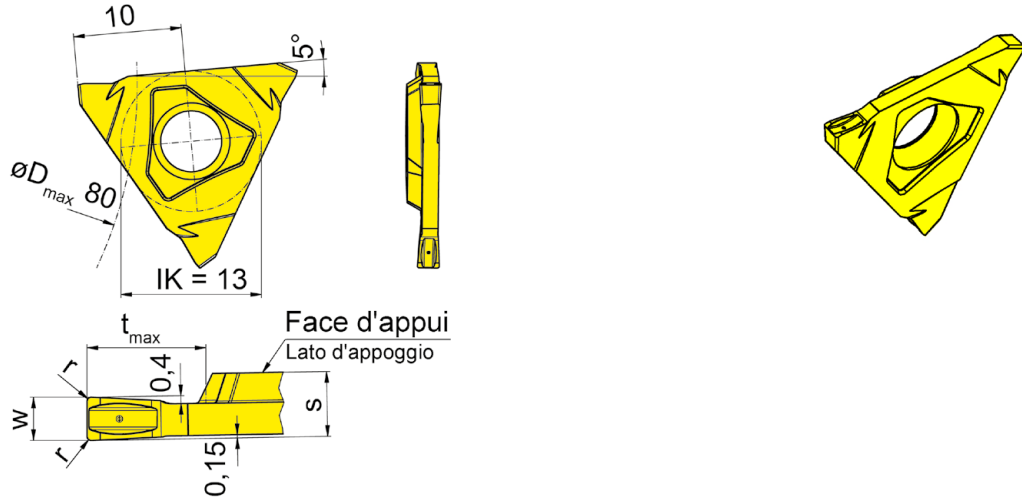
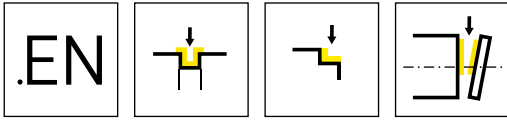

R = version à droite représentée
R = versione destra come in figura

L = version à gauche
L = versione sinistra a specchio

▲ en stock
a stock

Nuance
Leghe
Δ 4 semaines
4 settimane

N° de commande Codice prodotto	w	r	t _{max}	s	HIS	EG5G
RS315.0200.EN2	2	0,2	5,5	3	S31503R	▲
LS315.0200.EN2	2	0,2	5,5	3	S31503L	▲
						P ●
						M ○
						K ○
						N -
						S -
						H -



Plaquette amovible

Inserto

S315

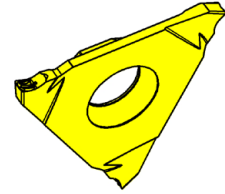
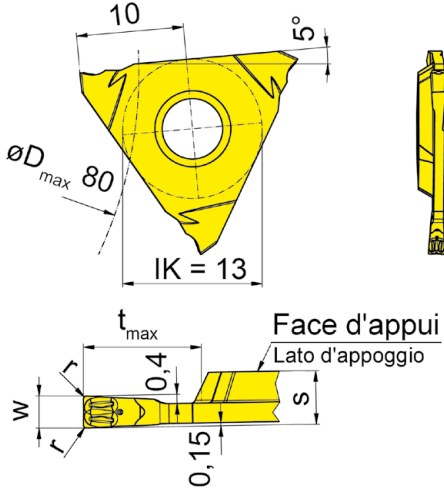
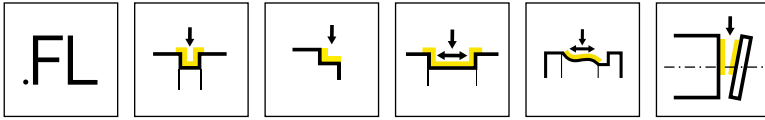

P

R = version à droite représentée
R = versione destra come in figura

L = version à gauche
L = versione sinistra a specchio

▲ en stock
a stock

Δ 4 semaines
4 settimane

Nuance
Leghe

N° de commande Codice prodotto	w	r	t _{max}	s	HIS	EG55
RS315.0150.FL15	1,5	0,15	5,5	2,5	S31503R	▲
LS315.0150.FL15	1,5	0,15	5,5	2,5	S31503L	▲
						P ●
						M ○
						K ○
						N -
						S -
						H -

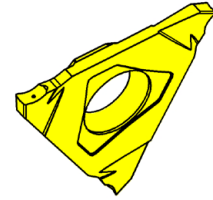
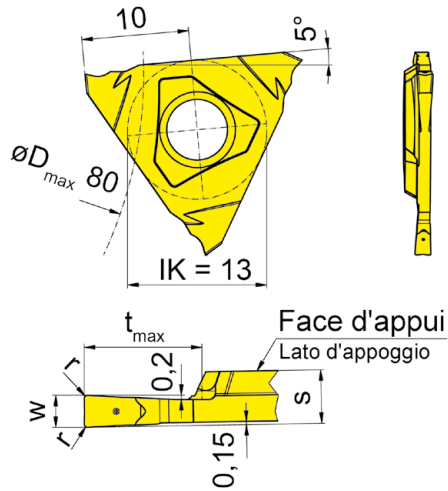
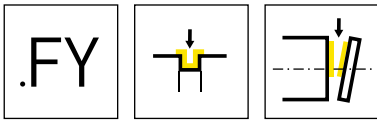

R = version à droite représentée
R = versione destra come in figura

L = version à gauche
L = versione sinistra a specchio

▲ en stock
a stock

Nuance
Leghe
Δ 4 semaines
4 settimane

N° de commande Codice prodotto	w	r	t _{max}	s	HIS	EG55
RS315.0150.FY15	1,5	0,15	5,5	2,5	S31503R	▲
RS315.0200.FY2	2	0,2	5,5	3	S31503R	▲
LS315.0150.FY15	1,5	0,15	5,5	2,5	S31503L	▲
LS315.0200.FY2	2	0,2	5,5	3	S31503L	▲
						P ●
						M ○
						K ○
						N -
						S -
						H -



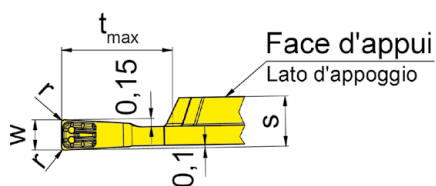
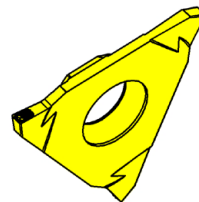
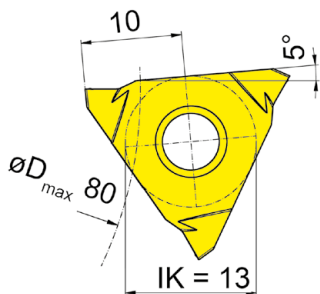
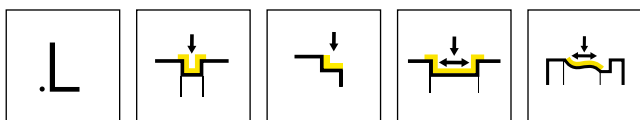

R = version à droite représentée
R = versione destra come in figura

L = version à gauche
L = versione sinistra a specchio

▲ en stock
a stock

Nuance
Leghe
Δ 4 semaines
4 settimane

N° de commande Codice prodotto	w	r	t _{max}	s	HIS	EG55
RS315.0110.L1	1,1	0,1	5,5	2,5	S31503R	▲
RS315.0130.L1	1,3	0,1	5,5	2,5	S31503R	▲
RS315.0150.L15	1,5	0,15	5,5	2,5	S31503R	▲
RS315.0200.L2	2	0,2	5,5	3	S31503R	▲
LS315.0110.L1	1,1	0,1	5,5	2,5	S31503L	▲
LS315.0130.L1	1,3	0,1	5,5	2,5	S31503L	▲
LS315.0150.L15	1,5	0,15	5,5	2,5	S31503L	▲
LS315.0200.L2	2	0,2	5,5	3	S31503L	▲

P	●
M	o
K	o
N	-
S	-
H	-