

229/259



H

Porte outils et plaquettes

Largeur de gorge 2,5 - 10 mm

Portainserito e inserti

Larghezza della gola 2,5 - 10 mm

Géométries et avances
Geometrie e avanzamenti

Page/Pag.
210-213

Base de support
Attacco Base
210/218/B229

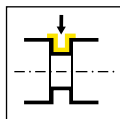

Page/Pag.
214, 217,
219-220

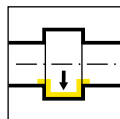

Page/Pag.
242-243

Porte outils
Portainsero
210/218/226/219
225/213/214/H259

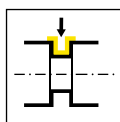

Page/Pag.
215-216, 218,
221-233, 272

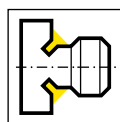

Page/Pag.
234

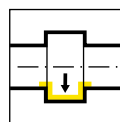

Page/Pag.
235-241

Cassette
Cartuccia
BK229/050

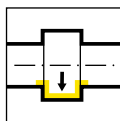

Page/Pag.
244-245

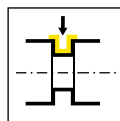

Page/Pag.
247

Cartouche
Cartuccia
257

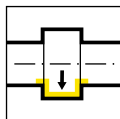

Page/Pag.
246

Plaquette amovible
 Inserto
 S229/229/259



Page/Pag.
248, 264, 269



Page/Pag.
249

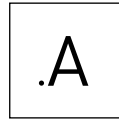

Page/Pag.
250

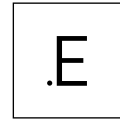

Page/Pag.
251

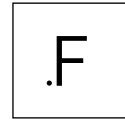

Page/Pag.
252

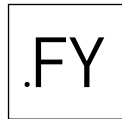

Page/Pag.
253

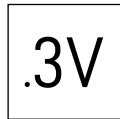

Page/Pag.
254

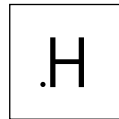

Page/Pag.
255



Page/Pag.
256

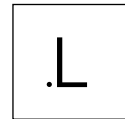

Page/Pag.
257-258

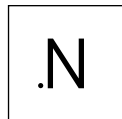

Page/Pag.
259

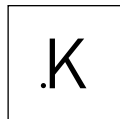

Page/Pag.
260



Page/Pag.
261

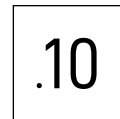

Page/Pag.
262

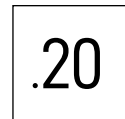

Page/Pag.
263



Page/Pag.
265

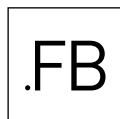

Page/Pag.
266

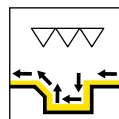

Page/Pag.
267

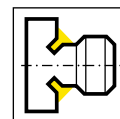

Page/Pag.
268

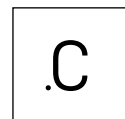

Page/Pag.
270-271

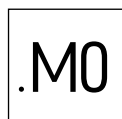

Page/Pag.
273



Géométrie Geometria	Matière Materiale	Avance f [mm/trs] Avanzamento f [mm/giro]	Usinage Lavorazione						
	<table border="1"> <tr> <td>P</td> <td>M</td> <td>K</td> </tr> <tr> <td>N</td> <td>S</td> <td>H</td> </tr> </table>	P	M	K	N	S	H	<p>↓ 0,15-0,25</p> <p>↔ 0,15-0,40</p>	
P	M	K							
N	S	H							
	<table border="1"> <tr> <td>P</td> <td>M</td> <td>K</td> </tr> <tr> <td>N</td> <td>S</td> <td>H</td> </tr> </table>	P	M	K	N	S	H	<p>↓ 0,10-0,45</p> <p>↔ 0,15-0,60</p>	
P	M	K							
N	S	H							
	<table border="1"> <tr> <td>P</td> <td>M</td> <td>K</td> </tr> <tr> <td>N</td> <td>S</td> <td>H</td> </tr> </table>	P	M	K	N	S	H	<p>↓ 0,05-0,30</p> <p>↔ 0,10-0,30</p>	
P	M	K							
N	S	H							
	<table border="1"> <tr> <td>P</td> <td>M</td> <td>K</td> </tr> <tr> <td>N</td> <td>S</td> <td>H</td> </tr> </table>	P	M	K	N	S	H	<p>↓ 0,08-0,30</p>	
P	M	K							
N	S	H							
	<table border="1"> <tr> <td>P</td> <td>M</td> <td>K</td> </tr> <tr> <td>N</td> <td>S</td> <td>H</td> </tr> </table>	P	M	K	N	S	H	<p>↓ 0,03-0,15</p>	
P	M	K							
N	S	H							

H

Géométrie Geometria	Matière Materiale	Avance f [mm/trs] Avanzamento f [mm/giro]	Usinage Lavorazione						
	<table border="1"> <tr> <td>P</td> <td>M</td> <td>K</td> </tr> <tr> <td>N</td> <td>S</td> <td>H</td> </tr> </table>	P	M	K	N	S	H	<p>↓ 0,03-0,15</p>	
P	M	K							
N	S	H							
	<table border="1"> <tr> <td>P</td> <td>M</td> <td>K</td> </tr> <tr> <td>N</td> <td>S</td> <td>H</td> </tr> </table>	P	M	K	N	S	H	<p>↓ 0,05-0,20</p>	
P	M	K							
N	S	H							
	<table border="1"> <tr> <td>P</td> <td>M</td> <td>K</td> </tr> <tr> <td>N</td> <td>S</td> <td>H</td> </tr> </table>	P	M	K	N	S	H	<p>↓ 0,15-0,25 ↔ 0,10-0,25</p>	
P	M	K							
N	S	H							
	<table border="1"> <tr> <td>P</td> <td>M</td> <td>K</td> </tr> <tr> <td>N</td> <td>S</td> <td>H</td> </tr> </table>	P	M	K	N	S	H	<p>↓ 0,20-0,30</p>	
P	M	K							
N	S	H							
	<table border="1"> <tr> <td>P</td> <td>M</td> <td>K</td> </tr> <tr> <td>N</td> <td>S</td> <td>H</td> </tr> </table>	P	M	K	N	S	H	<p>↓ 0,10-0,22 ↔ 0,05-0,20</p>	
P	M	K							
N	S	H							

H

Géométrie Geometria	Matière Materiale	Avance f [mm/trs] Avanzamento f [mm/giro]	Usinage Lavorazione						
	<table border="1"> <tr> <td>P</td> <td>M</td> <td>K</td> </tr> <tr> <td>N</td> <td>S</td> <td>H</td> </tr> </table>	P	M	K	N	S	H	<p>↓ 0,05-0,25</p> <p>↔ 0,05-0,25</p>	
P	M	K							
N	S	H							
	<table border="1"> <tr> <td>P</td> <td>M</td> <td>K</td> </tr> <tr> <td>N</td> <td>S</td> <td>H</td> </tr> </table>	P	M	K	N	S	H	<p>↓ 0,05-0,25</p> <p>↔ 0,05-0,25</p>	
P	M	K							
N	S	H							
	<table border="1"> <tr> <td>P</td> <td>M</td> <td>K</td> </tr> <tr> <td>N</td> <td>S</td> <td>H</td> </tr> </table>	P	M	K	N	S	H	<p>↓ 0,10-0,45</p> <p>↔ 0,05-0,25</p>	
P	M	K							
N	S	H							
	<table border="1"> <tr> <td>P</td> <td>M</td> <td>K</td> </tr> <tr> <td>N</td> <td>S</td> <td>H</td> </tr> </table>	P	M	K	N	S	H	<p>↓ 0,05-0,15</p>	
P	M	K							
N	S	H							
	<table border="1"> <tr> <td>P</td> <td>M</td> <td>K</td> </tr> <tr> <td>N</td> <td>S</td> <td>H</td> </tr> </table>	P	M	K	N	S	H	<p>↓ 0,07-0,25</p>	
P	M	K							
N	S	H							

H

Géométrie Geometria	Matière Materiale	Avance f [mm/trs] Avanzamento f [mm/giro]	Usinage Lavorazione						
.NC	<table border="1"> <tr> <td>P</td> <td>M</td> <td>K</td> </tr> <tr> <td>N</td> <td>S</td> <td>H</td> </tr> </table>	P	M	K	N	S	H	<p>↓ 0,02-0,10</p> <p>↔ 0,02-0,15</p>	
P	M	K							
N	S	H							
.FB	<table border="1"> <tr> <td>P</td> <td>M</td> <td>K</td> </tr> <tr> <td>N</td> <td>S</td> <td>H</td> </tr> </table>	P	M	K	N	S	H	<p>↓ 0,02-0,10</p> <p>↔ 0,0015-0,07</p>	
P	M	K							
N	S	H							
.C	<table border="1"> <tr> <td>P</td> <td>M</td> <td>K</td> </tr> <tr> <td>N</td> <td>S</td> <td>H</td> </tr> </table>	P	M	K	N	S	H	<p>↓ 0,02-0,10</p>	
P	M	K							
N	S	H							
.MO	<table border="1"> <tr> <td>P</td> <td>M</td> <td>K</td> </tr> <tr> <td>N</td> <td>S</td> <td>H</td> </tr> </table>	P	M	K	N	S	H	<p>↓ 0,02-0,10</p> <p>↔ 0,02-0,15</p>	
P	M	K							
N	S	H							

H

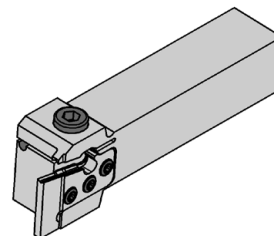
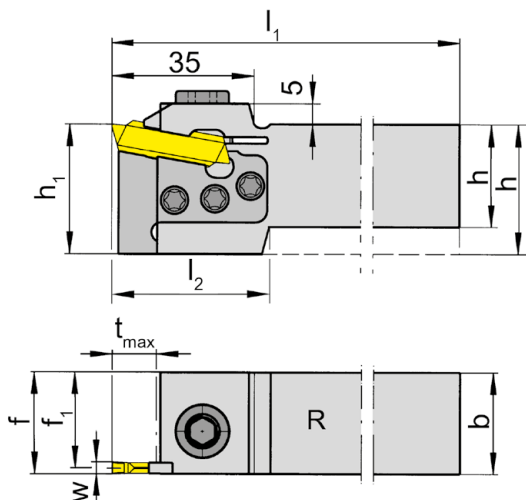
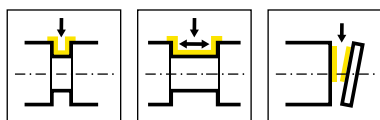

R = version à droite représentée
R = versione destra come in figura

L = version à gauche
L = versione sinistra a specchio

N° de commande Codice prodotto	h	b	l ₁	l ₂	h ₁	f ₁	f	t _{max}	HWS
R210.2525.K3	25	25	150	35	32	23,55	f ₁ +w/2	11	229030
R210.3225.K3	32	25	170	-	32	23,55	f ₁ +w/2	11	229030
R210.2525.K4	25	25	150	35	32	22,7	f ₁ +w/2	11	229040
R210.3225.K4	32	25	150	-	32	22,7	f ₁ +w/2	11	229040
R210.2525.K5	25	25	150	35	32	22,2	f ₁ +w/2	11	229050 • 229051
R210.3225.K5	32	25	170	-	32	22,2	f ₁ +w/2	11	229050 • 229051
R210.2525.K7	25	25	150	35	32	21,2	f ₁ +w/2	11	229070 • 229071
R210.3225.K7	32	25	170	-	32	21,2	f ₁ +w/2	11	229070 • 229071
L210.2525.K3	25	25	150	35	32	23,55	f ₁ +w/2	11	229030
L210.3225.K3	32	25	170	-	32	23,55	f ₁ +w/2	11	229030
L210.2525.K4	25	25	150	35	32	22,7	f ₁ +w/2	11	229040
L210.3225.K4	32	25	150	-	32	22,7	f ₁ +w/2	11	229040
L210.2525.K5	25	25	150	35	32	22,2	f ₁ +w/2	11	229050 • 229051
L210.3225.K5	32	25	170	-	32	22,2	f ₁ +w/2	11	229050 • 229051
L210.2525.K7	25	25	150	35	32	21,2	f ₁ +w/2	11	229070 • 229071
L210.3225.K7	32	25	170	-	32	21,2	f ₁ +w/2	11	229070 • 229071

w voir plaquettes amovibles
w vd. inserti

Pièces Détachées

Ricambi

Base de support Attacco Base	Vis de serrage Vite di serraggio	Cassette Cartuccia	Tournevis TORX PLUS® Cacciavite TORX PLUS®	Tournevis TORX Cacciavite TORX
R/L210...K3	030.0518.T20P	NK210.32.03	T20PQ	
R/L210...K4	030.0518.T20P	NK210.32.04	T20PQ	
R/L210...K5	030.0518.T20P	NK210.32.05	T20PQ	
R/L210...K7	030.0518.T20P	NK210.32.07	T20PQ	T15Q

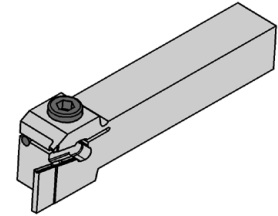
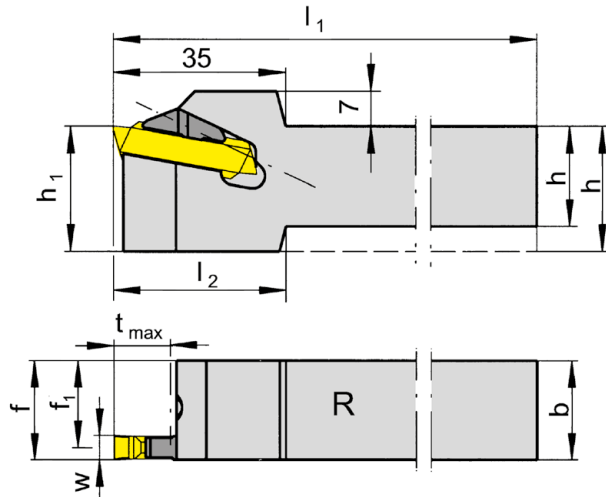
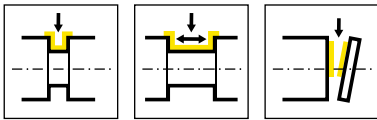

R = version à droite représentée
R = versione destra come in figura

L = version à gauche
L = versione sinistra a specchio

N° de commande Codice prodotto	h	b	l ₁	l ₂	h ₁	f ₁	f	t _{max}	HWS
R210.2020.09	20	20	150	35	25	15,2	f ₁ +w/2	11	229090 • 229091
R210.2525.09	25	25	150	-	25	20,2	f ₁ +w/2	11	229090 • 229091
R210.3225.09	32	25	170	-	32	20,2	f ₁ +w/2	11	229090 • 229091
L210.2020.09	20	20	150	35	25	15,2	f ₁ +w/2	11	229090 • 229091
L210.2525.09	25	25	150	-	25	20,2	f ₁ +w/2	11	229090 • 229091
L210.3225.09	32	25	170	-	32	20,2	f ₁ +w/2	11	229090 • 229091

w voir plaquettes amovibles
w vd. inserti

H

Pièces Détachées
Ricambi

Porte outils Portainsero	Bride Staffa	Tournevis TORX PLUS® Cacciavite TORX PLUS®
L210...	L218.9	T15PQ
R210...	R218.9	T15PQ

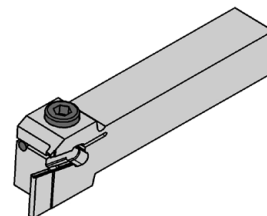
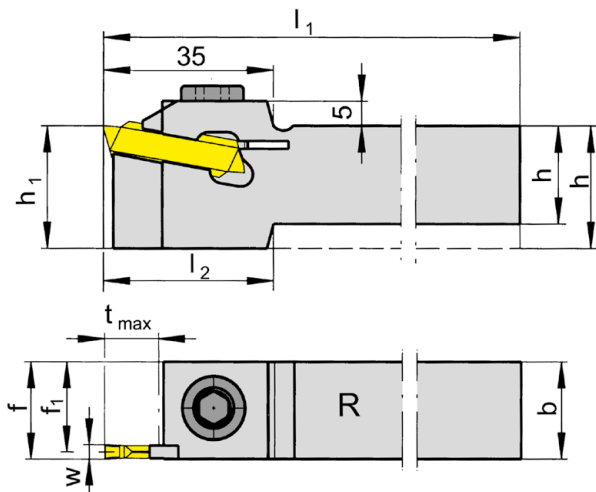
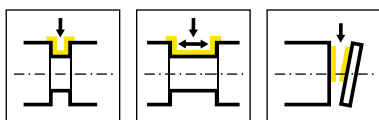

R = version à droite représentée
R = versione destra come in figura

L = version à gauche
L = versione sinistra a specchio

N° de commande Codice prodotto	h	b	l ₁	l ₂	h ₁	f ₁	f	t _{max}	HWS
R210.2020.02	20	20	150	35	25	18,55	f ₁ +w/2	11	229020
R210.2525.02	25	25	150	-	25	23,55	f ₁ +w/2	11	229020
R210.1616.03	16	16	150	45	25	14,55	f ₁ +w/2	11	229030
R210.2020.03	20	20	150	35	25	18,55	f ₁ +w/2	11	229030
R210.2525.03	25	25	150	-	25	23,55	f ₁ +w/2	11	229030
R210.3225.03	32	25	170	-	32	23,55	f ₁ +w/2	11	229030
R210.2020.04	20	20	150	35	25	17,7	f ₁ +w/2	11	229040
R210.2525.04	25	25	150	-	25	22,7	f ₁ +w/2	11	229040
R210.3225.04	32	25	170	-	32	22,7	f ₁ +w/2	11	229040
R210.2020.05	20	20	150	35	25	17,2	f ₁ +w/2	11	229050 • 229051
R210.2525.05	25	25	150	-	25	22,2	f ₁ +w/2	11	229050 • 229051
R210.3225.05	32	25	170	-	32	22,2	f ₁ +w/2	11	229050 • 229051
L210.2020.02	20	20	150	35	25	18,55	f ₁ +w/2	11	229020
L210.2525.02	25	25	150	-	25	23,55	f ₁ +w/2	11	229020
L210.1616.03	16	16	150	45	25	14,55	f ₁ +w/2	11	229030
L210.2020.03	20	20	150	35	25	18,55	f ₁ +w/2	11	229030
L210.2525.03	25	25	150	-	25	23,55	f ₁ +w/2	11	229030
L210.3225.03	32	25	170	-	32	23,55	f ₁ +w/2	11	229030
L210.2020.04	20	20	150	35	25	17,7	f ₁ +w/2	11	229040
L210.2525.04	25	25	150	-	25	22,7	f ₁ +w/2	11	229040
L210.3225.04	32	25	170	-	32	22,7	f ₁ +w/2	11	229040
L210.2020.05	20	20	150	35	25	17,2	f ₁ +w/2	11	229050 • 229051
L210.2525.05	25	25	150	-	25	22,2	f ₁ +w/2	11	229050 • 229051
L210.3225.05	32	25	170	-	32	22,2	f ₁ +w/2	11	229050 • 229051

w voir plaquettes amovibles
w vd. inserti

R/L 210...02 max. profondeur de gorge jusqu'à Ø 150 mm
R/L 210...02 profondità gola max. fino a Ø 150 mm

Pièces Détachées

Ricambi

Porte outils Portainsero	Vis de serrage Vite di serraggio
R/L210...	218.3

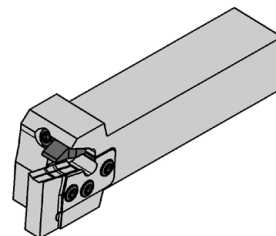
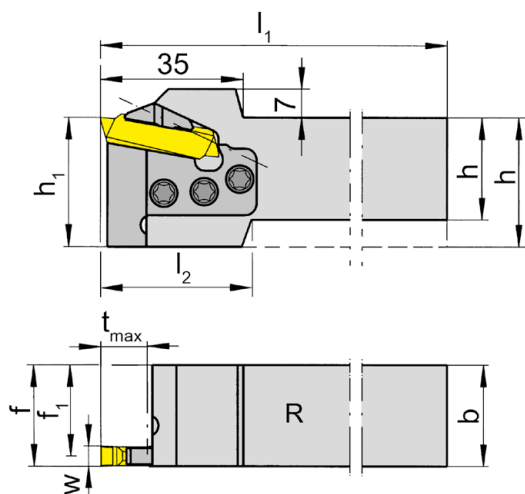
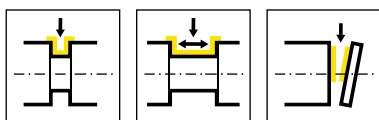

R = version à droite représentée
R = versione destra come in figura

L = version à gauche
L = versione sinistra a specchio

N° de commande Codice prodotto	h	b	l_1	l_2	h_1	f_1	f	t_{max}	HWS
R210.2525.K9	25	25	150	35	32	20,2	$f_1+w/2$	11	229090 • 229091
R210.3225.K9	32	25	170	-	32	20,2	$f_1+w/2$	11	229090 • 229091
L210.2525.K9	25	25	150	35	32	20,2	$f_1+w/2$	11	229090 • 229091
L210.3225.K9	32	25	170	-	32	20,2	$f_1+w/2$	11	229090 • 229091

w voir plaquettes amovibles
w vd. inserti

Pièces Détachées

Ricambi

Base de support Attacco Base	Vis de serrage Vite di serraggio	Cassette Cartuccia	Bride Staffa	Tournevis TORX PLUS® Cacciavite TORX PLUS®
R/L210...	030.0518.T20P	NK210.32.09	L218.9	T20PQ

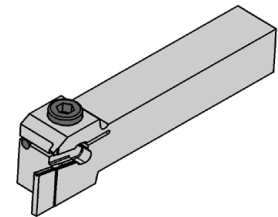
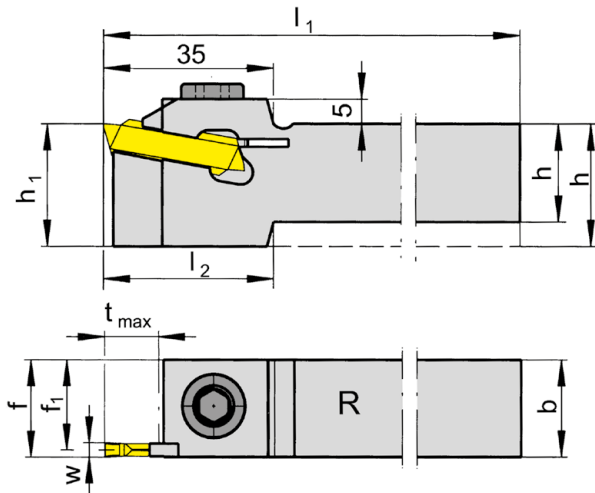
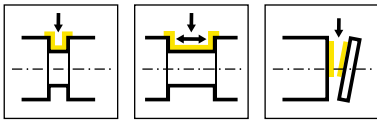

R = version à droite représentée
R = versione destra come in figura

L = version à gauche
L = versione sinistra a specchio

N° de commande Codice prodotto	h	b	l ₁	l ₂	h ₁	f ₁	f	t _{max}	HWS
R210.2020.07	20	20	150	35	25	16,2	f ₁ +w/2	11	229070 • 229071
R210.2525.07	25	25	150	-	25	21,2	f ₁ +w/2	11	229070 • 229071
R210.3225.07	32	25	170	-	32	21,2	f ₁ +w/2	11	229070 • 229071
R210.2020.08	20	20	150	35	25	16,2	f ₁ +w/2	11	229080 • 229081
R210.2525.08	25	25	150	-	25	21,2	f ₁ +w/2	11	229080 • 229081
L210.2020.07	20	20	150	35	25	16,2	f ₁ +w/2	11	229070 • 229071
L210.2525.07	25	25	150	-	25	21,2	f ₁ +w/2	11	229070 • 229071
L210.3225.07	32	25	170	-	32	21,2	f ₁ +w/2	11	229070 • 229071
L210.2020.08	20	20	150	35	25	16,2	f ₁ +w/2	11	229080 • 229081
L210.2525.08	25	25	150	-	25	21,2	f ₁ +w/2	11	229080 • 229081

w voir plaquettes amovibles
w vd. inserti

Pièces Détachées

Ricambi

Porte outils Portainsero	Vis de serrage Vite di serraggio
R/L210...	218.3

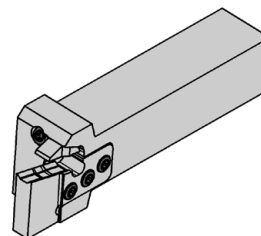
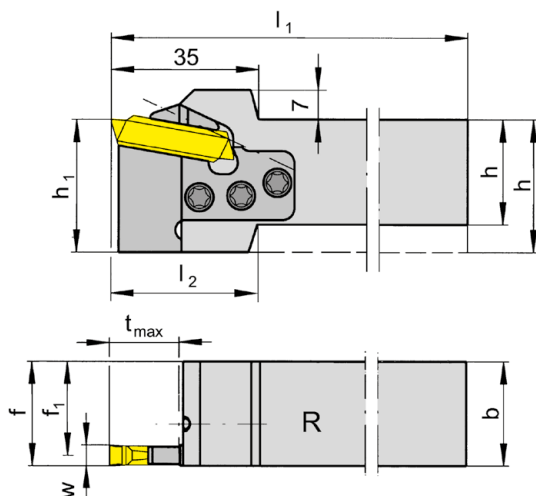
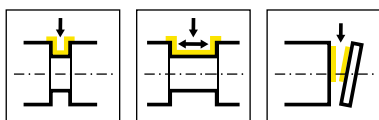

R = version à droite représentée
R = versione destra come in figura

L = version à gauche
L = versione sinistra a specchio

N° de commande Codice prodotto	h	b	l ₁	l ₂	h ₁	f ₁	f	t _{max}	HWS
R218.2525.K9	25	25	150	48	32	20,2	f ₁ +w/2	18	229090 • 229091
R218.3225.K9	32	25	170	-	32	20,2	f ₁ +w/2	18	229090 • 229091
L218.2525.K9	25	25	150	48	32	20,2	f ₁ +w/2	18	229090 • 229091
L218.3225.K9	32	25	170	-	32	20,2	f ₁ +w/2	18	229090 • 229091

w voir plaquettes amovibles
w vd. inserti

Pièces Détachées

Ricambi

Base de support Attacco Base	Vis de serrage Vite di serraggio	Cassette Cartuccia	Bride Staffa	Tournevis TORX PLUS® Cacciavite TORX PLUS®
R/L218...	030.0518.T20P	NK218.32.09	L218.9	T20PQ

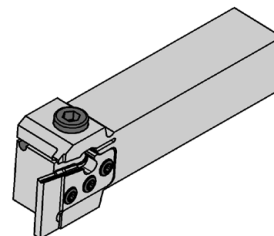
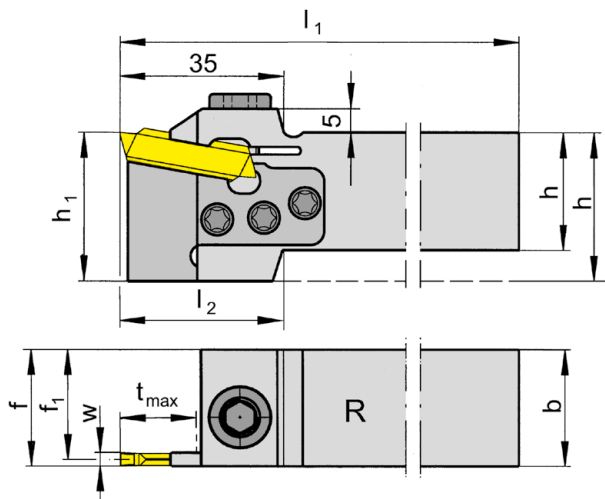
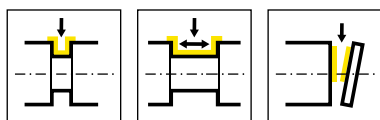

R = version à droite représentée
R = versione destra come in figura

L = version à gauche
L = versione sinistra a specchio

N° de commande Codice prodotto	h	b	l ₁	l ₂	h ₁	f ₁	f	t _{max}	HWS
R218.2525.K3	25	25	150	35	32	23,55	f ₁ +w/2	18	229030
R218.3225.K3	32	25	170	-	32	23,55	f ₁ +w/2	18	229030
R218.3225.K4	32	25	170	-	32	22,7	f ₁ +w/2	18	229040
R218.2525.K5	25	25	150	35	32	22,2	f ₁ +w/2	18	229050 • 229051
R218.3225.K5	32	25	170	-	32	22,2	f ₁ +w/2	18	229050 • 229051
R218.2525.K7	25	25	150	35	32	21,2	f ₁ +w/2	18	229070 • 229071
R218.3225.K7	32	25	170	-	32	21,2	f ₁ +w/2	18	229070 • 229071
L218.2525.K3	25	25	150	35	32	23,55	f ₁ +w/2	18	229030
L218.3225.K3	32	25	170	-	32	23,55	f ₁ +w/2	18	229030
L218.2525.K5	25	25	150	35	32	22,2	f ₁ +w/2	18	229050 • 229051
L218.3225.K5	32	25	170	-	32	22,2	f ₁ +w/2	18	229050 • 229051
L218.2525.K7	25	25	150	35	32	21,2	f ₁ +w/2	18	229070 • 229071
L218.3225.K7	32	25	170	-	32	21,2	f ₁ +w/2	18	229070 • 229071

w voir plaquettes amovibles
w vd. inserti

Pièces Détachées

Ricambi

Base de support Attacco Base	Vis de serrage Vite di serraggio	Cassette Cartuccia	Tournevis TORX PLUS® Cacciavite TORX PLUS®	Bride Staffa
R/L218...K3	030.0518.T20P	NK218.32.03	T20PQ	
R/L218...K4	030.0518.T20P	NK218.32.04	T20PQ	
R/L218...K5	030.0518.T20P	NK218.32.05	T20PQ	
R/L218...K7	030.0518.T20P	NK218.32.07	T20PQ	R/L218.5.7

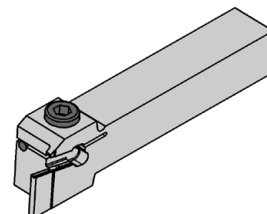
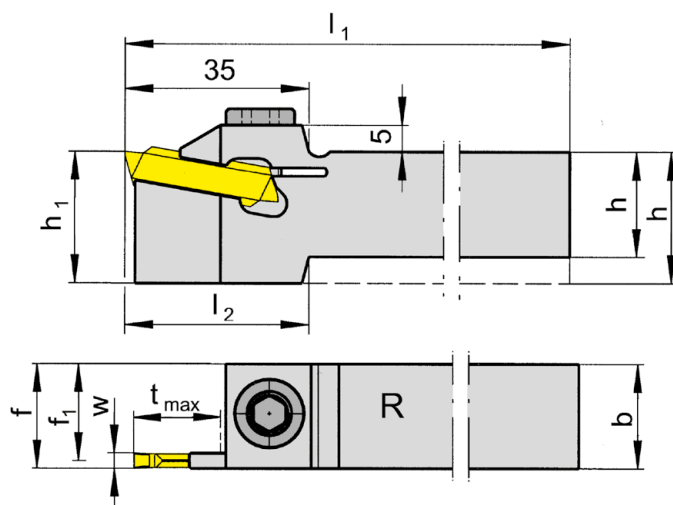
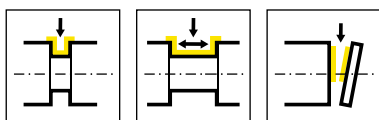

R = version à droite représentée
R = versione destra come in figura

L = version à gauche
L = versione sinistra a specchio

N° de commande Codice prodotto	h	b	l ₁	l ₂	h ₁	f ₁	f	t _{max}	D _{max}	HWS
R218.2020.02	20	20	150	35	25	18,55	f ₁ +w/2	18	80	229020
R218.2525.02	25	25	150	-	25	23,55	f ₁ +w/2	18	80	229020
R218.1616.03	16	16	150	45	25	14,55	f ₁ +w/2	18	-	229030
R218.2020.03	20	20	150	35	25	18,55	f ₁ +w/2	18	-	229030
R218.2525.03	25	25	150	-	25	23,55	f ₁ +w/2	18	-	229030
R218.3225.03	32	25	170	-	32	23,55	f ₁ +w/2	18	-	229030
R218.2020.04	20	20	150	35	25	17,7	f ₁ +w/2	18	-	229040
R218.2525.04	25	25	150	-	25	22,7	f ₁ +w/2	18	-	229040
R218.3225.04	32	25	170	-	32	22,7	f ₁ +w/2	18	-	229040
R218.2020.05	20	20	150	35	25	17,2	f ₁ +w/2	18	-	229050 • 229051
R218.2525.05	25	25	150	-	25	22,2	f ₁ +w/2	18	-	229050 • 229051
R218.3225.05	32	25	170	-	32	22,2	f ₁ +w/2	18	-	229050 • 229051
L218.2020.02	20	20	150	35	25	18,55	f ₁ +w/2	18	80	229020
L218.2525.02	25	25	150	-	25	23,55	f ₁ +w/2	18	80	229020
L218.1616.03	16	16	150	45	25	14,55	f ₁ +w/2	18	-	229030
L218.2020.03	20	20	150	35	25	18,55	f ₁ +w/2	18	-	229030
L218.2525.03	25	25	150	-	25	23,55	f ₁ +w/2	18	-	229030
L218.3225.03	32	25	170	-	32	23,55	f ₁ +w/2	18	-	229030
L218.2020.04	20	20	150	35	25	17,7	f ₁ +w/2	18	-	229040
L218.2525.04	25	25	150	-	25	22,7	f ₁ +w/2	18	-	229040
L218.3225.04	32	25	170	-	32	22,7	f ₁ +w/2	18	-	229040
L218.2020.05	20	20	150	35	25	17,2	f ₁ +w/2	18	-	229050 • 229051
L218.2525.05	25	25	150	-	25	22,2	f ₁ +w/2	18	-	229050 • 229051
L218.3225.05	32	25	170	-	32	22,2	f ₁ +w/2	18	-	229050 • 229051

w voir plaquettes amovibles
w vd. inserti

R/L 218...02 max. profondeur de gorge jusqu'à Ø 80 mm
R/L 218...02 profondità gola max. fino a Ø 80 mm

Pièces Détachées

Ricambi

Porte outils Portainsero	Vis de serrage Vite di serraggio
R/L218...	218.3

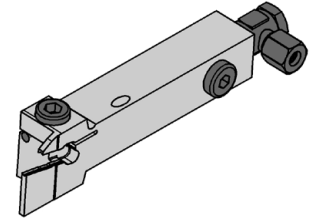
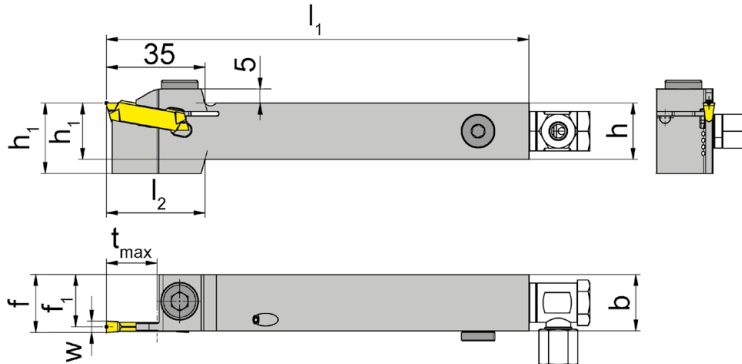
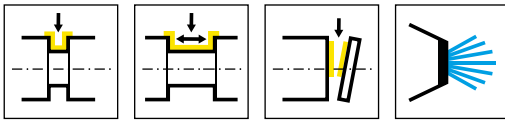

R = version à droite représentée
R = versione destra come in figura

L = version à gauche
L = versione sinistra a specchio

N° de commande Codice prodotto	h	b	l ₁	l ₂	h ₁	f ₁	f	t _{max}	D _{max}	HWS
R218.2525.02.IK	25	25	150	-	25	23,55	f ₁ +w/2	18	80	229020
R218.1616.03.IK	16	16	150	45	25	14,55	f ₁ +w/2	18	-	229030
R218.2020.03.IK	20	20	150	35	25	18,55	f ₁ +w/2	18	-	229030
R218.2525.03.IK	25	25	150	-	25	23,55	f ₁ +w/2	18	-	229030
L218.2020.02.IK	20	20	150	35	25	18,55	f ₁ +w/2	18	80	229020
L218.2525.02.IK	25	25	150	-	25	23,55	f ₁ +w/2	18	80	229020
L218.1616.03.IK	16	16	150	45	25	14,55	f ₁ +w/2	18	-	229030
L218.2020.03.IK	20	20	150	35	25	18,55	f ₁ +w/2	18	-	229030
L218.2525.03.IK	25	25	150	-	25	23,55	f ₁ +w/2	18	-	229030
L218.3225.03.IK	32	25	170	-	32	23,55	f ₁ +w/2	18	-	229030

w voir plaquettes amovibles
w vd. inserti

R/L 218...02 max. profondeur de gorge jusqu'à Ø 80 mm
R/L 218...02 profondità gola max. fino a Ø 80 mm

Pièces Détachées

Ricambi

Porte outils Portainsero	Vis de serrage Vite di serraggio	Arrosage Lubrificazione	Vis Vite
R/L218...	218.3	004.00.16	004.00.26

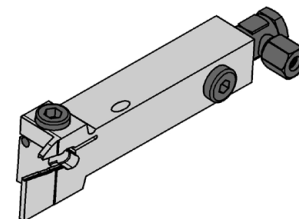
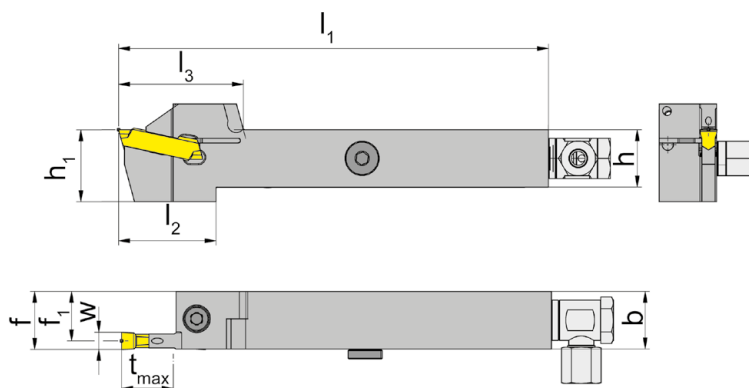
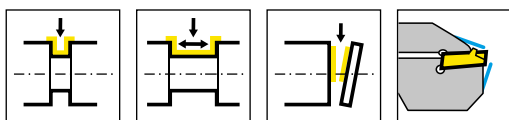

R = version à droite représentée
R = versione destra come in figura

L = version à gauche
L = versione sinistra a specchio

N° de commande Codice prodotto	h	b	l ₁	l ₂	l ₃	h ₁	f ₁	f	t _{max}	HWS
R218.1616.0.03.IK	16	16	150	37	43,5	25	14,55	f ₁ +w/2	18	229030
R218.2020.0.03.IK	20	20	150	34	43,5	25	18,55	f ₁ +w/2	18	229030
R218.2525.0.03.IK	25	25	150	32	43,5	32	23,55	f ₁ +w/2	18	229030
R218.2020.0.04.IK	20	20	150	34	43,5	25	17,7	f ₁ +w/2	18	229040
R218.2020.0.05.IK	20	20	150	34	43,5	25	17,2	f ₁ +w/2	18	229050 • 229051
R218.2525.0.04.IK	25	25	150	32	43,5	32	22,7	f ₁ +w/2	18	229040
R218.2525.0.05.IK	25	25	150	32	43,5	32	22,2	f ₁ +w/2	18	229050 • 229051
L218.1616.0.03.IK	16	16	150	37	43,5	25	14,55	f ₁ +w/2	18	229030
L218.2020.0.03.IK	20	20	150	34	43,5	25	18,55	f ₁ +w/2	18	229030
L218.2525.0.03.IK	25	25	150	32	43,5	32	23,55	f ₁ +w/2	18	229030
L218.2020.0.04.IK	20	20	150	34	43,5	25	17,7	f ₁ +w/2	18	229040
L218.2020.0.05.IK	20	20	150	34	43,5	25	17,2	f ₁ +w/2	18	229050 • 229051
L218.2525.0.04.IK	25	25	150	32	43,5	32	22,7	f ₁ +w/2	18	229040
L218.2525.0.05.IK	25	25	150	32	43,5	32	22,2	f ₁ +w/2	18	229050 • 229051

w voir plaquettes amovibles
w vd. inserti

Pièces Détachées

Ricambi

Porte outils Portainsero	Arrosage Lubrificazione	Vis de serrage Vite di serraggio	Tournevis TORX PLUS® Cacciavite TORX PLUS®	Vis Vite
R/L218...	004.00.16	6.23T25P	T25PQ	004.00.26

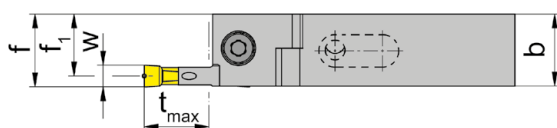
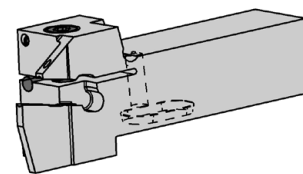
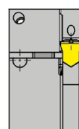
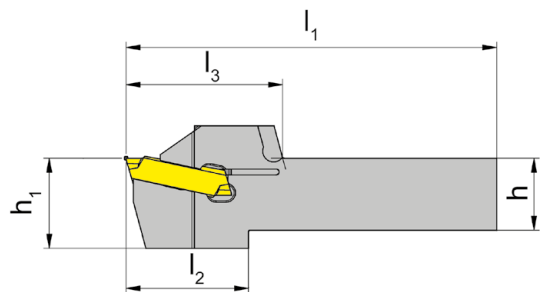
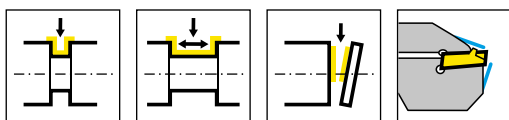

R = version à droite représentée
R = versione destra come in figura

L = version à gauche
L = versione sinistra a specchio

N° de commande Codice prodotto	h	b	l ₁	l ₂	l ₃	h ₁	f ₁	f	t _{max}	HWS
R218.1616.2.03.IK	16	16	91	37	43,5	25	14,55	f ₁ +w/2	18	229030
R218.1616.2.04.IK	16	16	91	37	43,5	25	13,7	f ₁ +w/2	18	229040
R218.1616.2.05.IK	16	16	91	37	43,5	25	13,2	f ₁ +w/2	18	229050 • 229051
R218.2020.2.03.IK	20	20	103	34	43,5	25	18,55	f ₁ +w/2	18	229030
R218.2020.2.04.IK	20	20	103	34	43,5	25	17,7	f ₁ +w/2	18	229040
R218.2020.2.05.IK	20	20	103	34	43,5	25	17,2	f ₁ +w/2	18	229050 • 229051
R218.2525.2.03.IK	25	25	116	32	43,5	32	23,55	f ₁ +w/2	18	229030
R218.2525.2.04.IK	25	25	116	32	43,5	32	22,7	f ₁ +w/2	18	229040
R218.2525.2.05.IK	25	25	116	32	43,5	32	22,2	f ₁ +w/2	18	229050 • 229051
R218.2525.2.07.IK	25	25	116	32	43,5	32	21,2	f ₁ +w/2	18	229070 • 229071
R218.2525.2.08.IK	25	25	116	32	43,5	32	21,2	f ₁ +w/2	18	229080 • 229081
L218.1616.2.03.IK	16	16	91	37	43,5	25	14,55	f ₁ +w/2	18	229030
L218.1616.2.04.IK	16	16	91	37	43,5	25	13,7	f ₁ +w/2	18	229040
L218.1616.2.05.IK	16	16	91	37	43,5	25	13,2	f ₁ +w/2	18	229050 • 229051
L218.2020.2.03.IK	20	20	103	34	43,5	25	18,55	f ₁ +w/2	18	229030
L218.2020.2.04.IK	20	20	103	34	43,5	25	17,7	f ₁ +w/2	18	229040
L218.2020.2.05.IK	20	20	103	34	43,5	25	17,2	f ₁ +w/2	18	229050 • 229051
L218.2525.2.03.IK	25	25	116	32	43,5	32	23,55	f ₁ +w/2	18	229030
L218.2525.2.04.IK	25	25	116	32	43,5	32	22,7	f ₁ +w/2	18	229040
L218.2525.2.05.IK	25	25	116	32	43,5	32	22,2	f ₁ +w/2	18	229050 • 229051
L218.2525.2.07.IK	25	25	116	32	43,5	32	21,2	f ₁ +w/2	18	229070 • 229071
L218.2525.2.08.IK	25	25	116	32	43,5	32	21,2	f ₁ +w/2	18	229080 • 229081

w voir plaquettes amovibles
w vd. inserti

Pièces Détachées

Ricambi

Porte outils Portainsero	Vis de serrage Vite di serraggio	Tournevis TORX PLUS® Cacciavite TORX PLUS®
R/L218...	6.23T25P	T25PQ

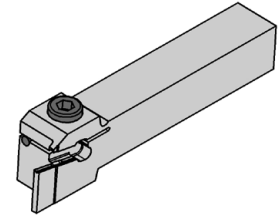
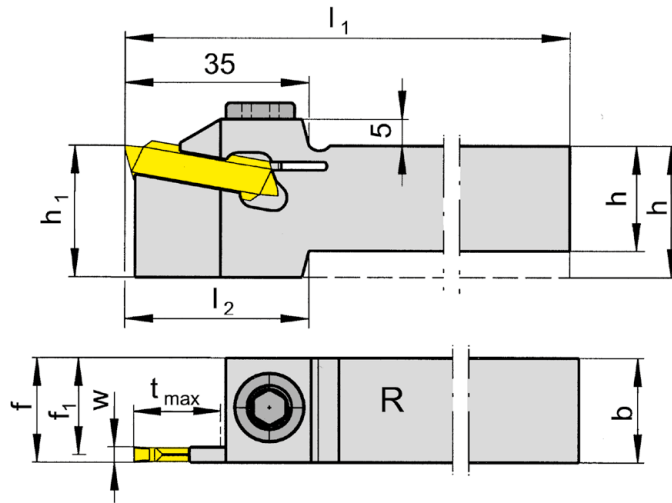
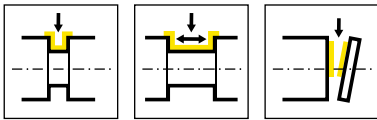

R = version à droite représentée
R = versione destra come in figura

L = version à gauche
L = versione sinistra a specchio

N° de commande Codice prodotto	h	b	l ₁	l ₂	h ₁	f ₁	f	t _{max}	HWS
R218.2020.07	20	20	150	35	25	16,2	f ₁ +w/2	18	229070 • 229071
R218.2525.07	25	25	150	-	25	21,2	f ₁ +w/2	18	229070 • 229071
R218.3225.07	32	25	170	-	32	21,2	f ₁ +w/2	18	229070 • 229071
L218.2020.07	20	20	150	35	25	16,2	f ₁ +w/2	18	229070 • 229071
L218.2525.07	25	25	150	-	25	21,2	f ₁ +w/2	18	229070 • 229071
L218.3225.07	32	25	170	-	32	21,2	f ₁ +w/2	18	229070 • 229071
L218.2525.08	25	25	150	-	25	21,2	f ₁ +w/2	18	229080 • 229081

w voir plaquettes amovibles
w vd. inserti

H

Pièces Détachées
Ricambi

Porte outils Portainsero	Vis de serrage Vite di serraggio
R/L218...	218.3

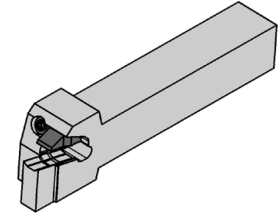
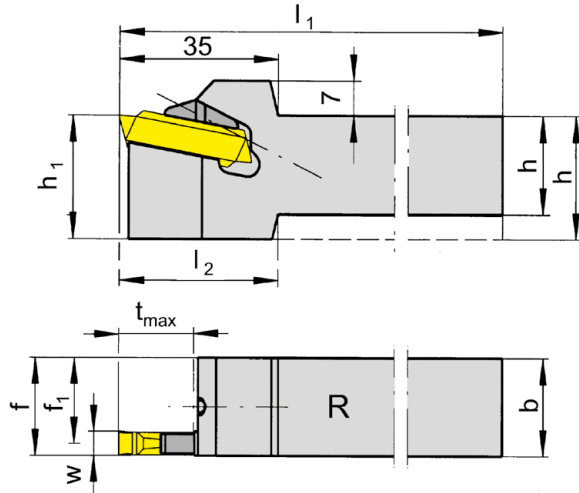
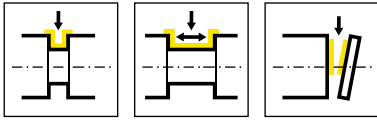

R = version à droite représentée
R = versione destra come in figura

L = version à gauche
L = versione sinistra a specchio

N° de commande Codice prodotto	h	b	l ₁	l ₂	h ₁	f ₁	f	t _{max}	HWS
R218.2020.09	20	20	150	35	25	15,2	f ₁ +w/2	18	229090 • 229091
R218.2525.09	25	25	150	-	25	20,2	f ₁ +w/2	18	229090 • 229091
R218.3225.09	32	25	170	-	32	20,2	f ₁ +w/2	18	229090 • 229091
L218.2020.09	20	20	150	35	25	15,2	f ₁ +w/2	18	229090 • 229091
L218.3225.09	32	25	170	-	32	20,2	f ₁ +w/2	18	229090 • 229091

w voir plaquettes amovibles
w vd. inserti

H

Pièces Détachées

Ricambi

Porte outils Portainserito	Bride Staffa	Tournevis TORX PLUS® Cacciavite TORX PLUS®
L218...	L218.9	T15PQ
R218...	R218.9	T15PQ

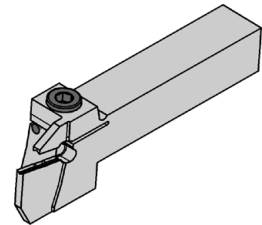
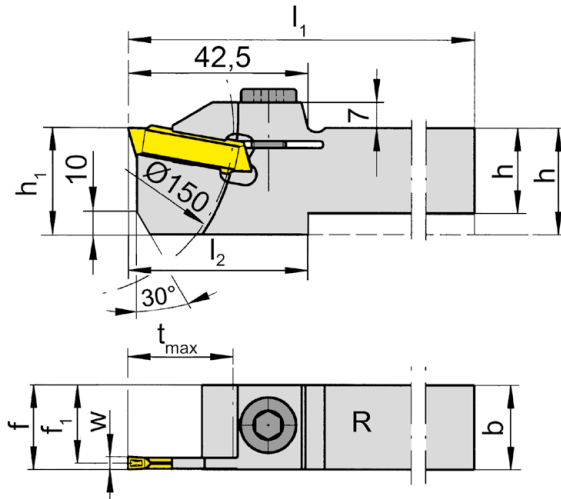
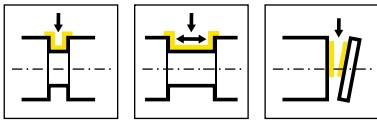

R = version à droite représentée
R = versione destra come in figura

L = version à gauche
L = versione sinistra a specchio

N° de commande Codice prodotto	h	b	l ₁	l ₂	h ₁	f ₁	f	t _{max}	HWS
R226.1616.03	16	16	150	52,5	32	14,55	f ₁ +w/2	25	229030
R226.2020.03	20	20	150	42,5	32	18,55	f ₁ +w/2	25	229030
R226.2525.03	25	25	150	42,5	32	23,55	f ₁ +w/2	25	229030
R226.3225.03	32	25	170	-	32	23,55	f ₁ +w/2	25	229030
R226.1616.04	16	16	150	52,5	32	13,7	f ₁ +w/2	25	229040
R226.2020.04	20	20	150	42,5	32	17,7	f ₁ +w/2	25	229040
R226.2525.04	25	25	150	42,5	32	22,7	f ₁ +w/2	25	229040
R226.3225.04	32	25	170	-	32	22,7	f ₁ +w/2	25	229040
R226.2020.05	20	20	150	42,5	32	17,2	f ₁ +w/2	25	229050 • 229051
R226.2525.05	25	25	150	42,5	32	22,2	f ₁ +w/2	25	229050 • 229051
R226.3225.05	32	25	170	-	32	22,2	f ₁ +w/2	25	229050 • 229051
L226.1616.03	16	16	150	52,5	32	14,55	f ₁ +w/2	25	229030
L226.2020.03	20	20	150	42,5	32	18,55	f ₁ +w/2	25	229030
L226.2525.03	25	25	150	42,5	32	23,55	f ₁ +w/2	25	229030
L226.3225.03	32	25	170	-	32	23,55	f ₁ +w/2	25	229030
L226.1616.04	16	16	150	52,5	32	13,7	f ₁ +w/2	25	229040
L226.2020.04	20	20	150	42,5	32	17,7	f ₁ +w/2	25	229040
L226.2525.04	25	25	150	42,5	32	22,7	f ₁ +w/2	25	229040
L226.3225.04	32	25	170	-	32	22,7	f ₁ +w/2	25	229040
L226.2020.05	20	20	150	42,5	32	17,2	f ₁ +w/2	25	229050 • 229051
L226.2525.05	25	25	150	42,5	32	22,2	f ₁ +w/2	25	229050 • 229051
L226.3225.05	32	25	170	-	32	22,2	f ₁ +w/2	25	229050 • 229051

w voir plaquettes amovibles
w vd. inserti

Pièces Détachées

Ricambi

Porte outils Portainsero	Vis de serrage Vite di serraggio
R/L226...	218.3

H

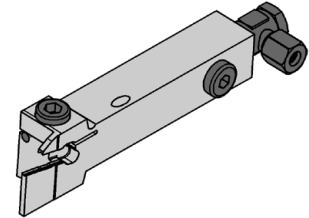
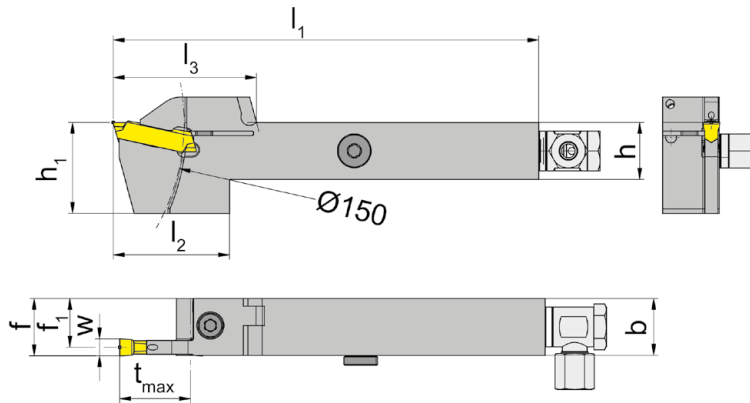
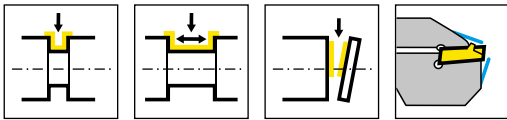

R = version à droite représentée
R = versione destra come in figura

L = version à gauche
L = versione sinistra a specchio

N° de commande Codice prodotto	h	b	l ₁	l ₂	l ₃	h ₁	f ₁	f	t _{max}	HWS
R226.2020.0.03.IK	20	20	150	41	50,5	32	18,55	f ₁ +w/2	25	229030
R226.2525.0.03.IK	25	25	150	39	50,5	32	23,55	f ₁ +w/2	25	229030
R226.2020.0.04.IK	20	20	150	41	50,5	32	17,7	f ₁ +w/2	25	229040
R226.2525.0.04.IK	25	25	150	39	50,5	32	22,7	f ₁ +w/2	25	229040
R226.2020.0.05.IK	20	20	150	41	50,5	32	17,2	f ₁ +w/2	25	229050 • 229051
R226.2525.0.05.IK	25	25	150	39	50,5	32	22,2	f ₁ +w/2	25	229050 • 229051
L226.2020.0.03.IK	20	20	150	41	50,5	32	18,55	f ₁ +w/2	25	229030
L226.2525.0.03.IK	25	25	150	39	50,5	32	23,55	f ₁ +w/2	25	229030
L226.2020.0.04.IK	20	20	150	41	50,5	32	17,7	f ₁ +w/2	25	229040
L226.2525.0.04.IK	25	25	150	39	50,5	32	22,7	f ₁ +w/2	25	229040
L226.2020.0.05.IK	20	20	150	41	50,5	32	17,2	f ₁ +w/2	25	229050 • 229051
L226.2525.0.05.IK	25	25	150	39	50,5	32	22,2	f ₁ +w/2	25	229050 • 229051

w voir plaquettes amovibles
w vd. inserti

Pièces Détachées

Ricambi

Porte outils Portainsero	Arrosage Lubrificazione	Vis de serrage Vite di serraggio	Tournevis TORX PLUS® Cacciavite TORX PLUS®	Vis Vite
R/L226...	004.00.16	6.23T25P	T25PQ	004.00.26

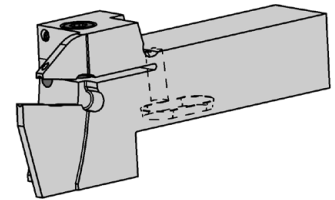
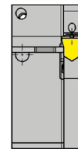
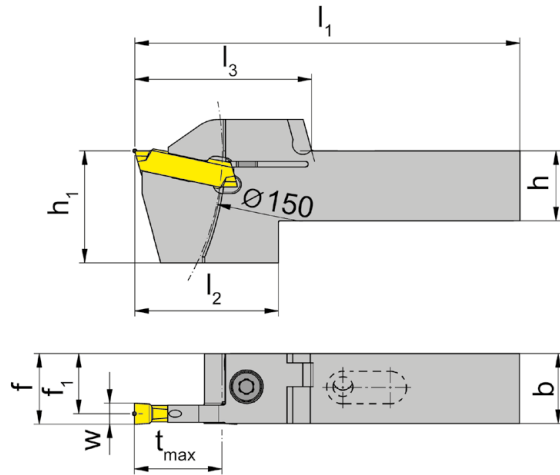
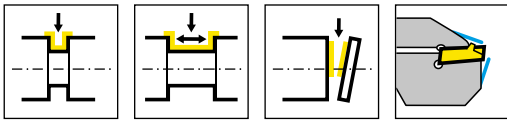

R = version à droite représentée
R = versione destra come in figura

L = version à gauche
L = versione sinistra a specchio

N° de commande Codice prodotto	h	b	l ₁	l ₂	l ₃	h ₁	f ₁	f	t _{max}	HWS
R226.2020.2.03.IK	20	20	110	41	50,5	32	18,55	f ₁ +w/2	25	229030
R226.2020.2.04.IK	20	20	110	41	50,5	32	17,7	f ₁ +w/2	25	229040
R226.2525.2.03.IK	25	25	123	39	50,5	32	23,55	f ₁ +w/2	25	229030
R226.2525.2.04.IK	25	25	123	39	50,5	32	22,7	f ₁ +w/2	25	229040
R226.2525.2.05.IK	25	25	123	39	50,5	32	22,2	f ₁ +w/2	25	229050 • 229051
L226.2020.2.03.IK	20	20	110	41	50,5	32	18,55	f ₁ +w/2	25	229030
L226.2020.2.04.IK	20	20	110	41	50,5	32	17,7	f ₁ +w/2	25	229040
L226.2020.2.05.IK	20	20	110	41	50,5	32	17,2	f ₁ +w/2	25	229050 • 229051
L226.2525.2.03.IK	25	25	123	39	50,5	32	23,55	f ₁ +w/2	25	229030
L226.2525.2.04.IK	25	25	123	39	50,5	32	22,7	f ₁ +w/2	25	229040
L226.2525.2.05.IK	25	25	123	39	50,5	32	22,2	f ₁ +w/2	25	229050 • 229051

w voir plaquettes amovibles
w vd. inserti

Pièces Détachées

Ricambi

Porte outils Portainsero	Vis de serrage Vite di serraggio	Tournevis TORX PLUS® Cacciavite TORX PLUS®
R/L226...	6.23T25P	T25PQ

H

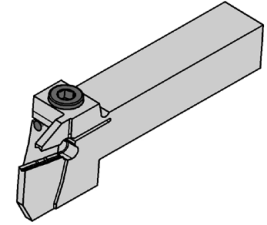
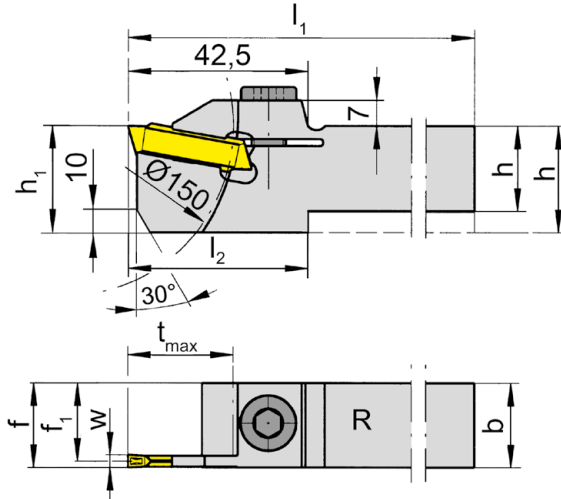
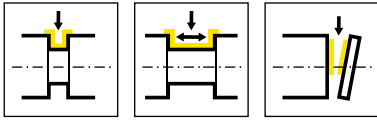

R = version à droite représentée
R = versione destra come in figura

L = version à gauche
L = versione sinistra a specchio

N° de commande Codice prodotto	h	b	l ₁	l ₂	h ₁	f ₁	f	t _{max}	HWS
R226.2525.07	25	25	150	42,5	32	21,2	f ₁ +w/2	25	229070 • 229071
R226.3225.07	32	25	170	-	32	21,2	f ₁ +w/2	25	229070 • 229071
R226.2525.08	25	25	150	42,5	32	21,2	f ₁ +w/2	25	229080 • 229081
R226.3225.08	32	25	170	-	32	21,2	f ₁ +w/2	25	229080 • 229081
L226.2525.07	25	25	150	42,5	32	21,2	f ₁ +w/2	25	229070 • 229071
L226.3225.07	32	25	170	-	32	21,2	f ₁ +w/2	25	229070 • 229071
L226.2525.08	25	25	150	42,5	32	20,2	f ₁ +w/2	25	229080 • 229081
L226.3225.08	32	25	170	-	32	21,2	f ₁ +w/2	25	229080 • 229081

w voir plaquettes amovibles
w vd. inserti

Pièces Détachées

Ricambi

Porte outils Portainsero	Vis de serrage Vite di serraggio
R/L226...	218.3



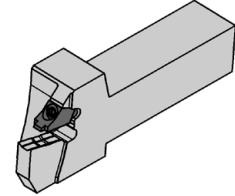
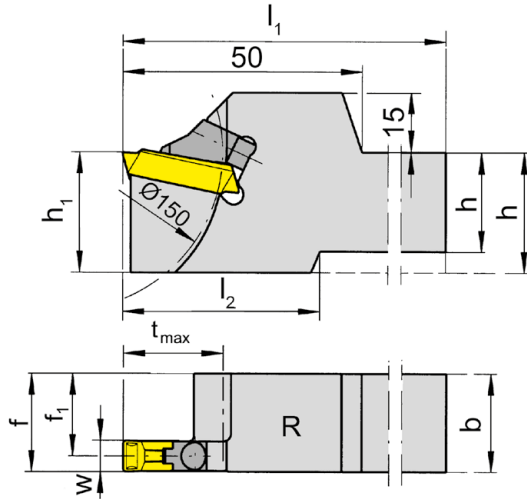
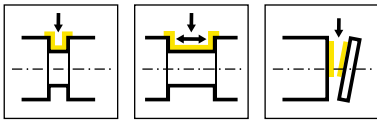

R = version à droite représentée
R = versione destra come in figura

L = version à gauche
L = versione sinistra a specchio

N° de commande Codice prodotto	h	b	l ₁	l ₂	h ₁	f ₁	f	t _{max}	HWS
R226.2525.09	25	25	150	50	32	20,2	f ₁ +w/2	25	229090 • 229091
R226.3225.09	32	25	170	-	32	20,2	f ₁ +w/2	25	229090 • 229091
L226.2525.09	25	25	150	50	32	20,2	f ₁ +w/2	25	229090 • 229091
L226.3225.09	32	25	170	-	32	20,2	f ₁ +w/2	25	229090 • 229091

w voir plaquettes amovibles
w vd. inserti

Pièces Détachées

Ricambi

Porte outils Portainsero	Bride Staffa	Tournevis TORX PLUS® Cacciavite TORX PLUS®
R/L226...	020.1008.0041	T15PQ

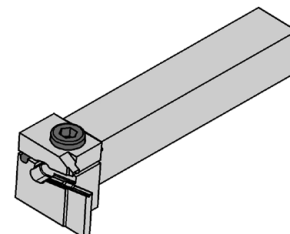
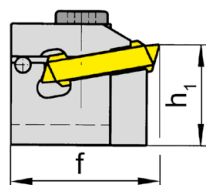
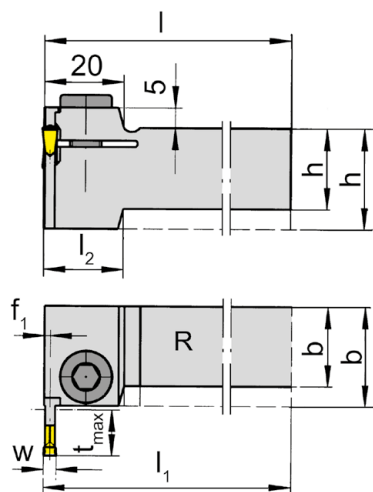
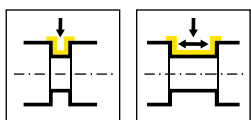

R = version à droite représentée
R = versione destra come in figura

L = version à gauche
L = versione sinistra a specchio

N° de commande Codice prodotto	h	b	l	l_1	l_2	h_1	f	f_1	t_{max}	HWS
R219.2020.03	20	20	150	$l-f_1+w/2$	20	25	37	1,45	11	229030
R219.2525.03	25	25	150	$l-f_1+w/2$	-	25	37	1,45	11	229030
R219.2020.04	20	20	150	$l-f_1+w/2$	20	25	37	2,3	11	229040
R219.2525.04	25	25	150	$l-f_1+w/2$	-	25	37	2,3	11	229040
R219.2020.05	20	20	150	$l-f_1+w/2$	23	25	45	2,8	15	229050 • 229051
R219.2525.05	25	25	150	$l-f_1+w/2$	-	25	45	2,8	15	229050 • 229051
R219.2020.07	20	20	150	$l-f_1+w/2$	23	25	45	3,8	15	229070 • 229071
R219.2525.07	25	25	150	$l-f_1+w/2$	-	25	45	3,8	15	229070 • 229071
L219.2020.03	20	20	150	$l-f_1+w/2$	20	25	37	1,45	11	229030
L219.2525.03	25	25	150	$l-f_1+w/2$	-	25	37	1,45	11	229030
L219.2020.04	20	20	150	$l-f_1+w/2$	20	25	37	2,3	11	229040
L219.2525.04	25	25	150	$l-f_1+w/2$	-	25	37	2,3	11	229040
L219.2020.05	20	20	150	$l-f_1+w/2$	23	25	45	2,8	15	229050 • 229051
L219.2525.05	25	25	150	$l-f_1+w/2$	-	25	45	2,8	15	229050 • 229051
L219.2020.07	20	20	150	$l-f_1+w/2$	23	25	45	3,8	15	229070 • 229071
L219.2525.07	25	25	150	$l-f_1+w/2$	-	25	45	3,8	15	229070 • 229071

w voir plaquettes amovibles
w vd. inserti

Pièces Détachées

Ricambi

Porte outils Portainsero	Vis de serrage Vite di serraggio
R/L219...	218.3

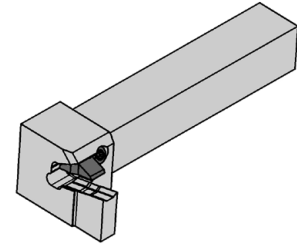
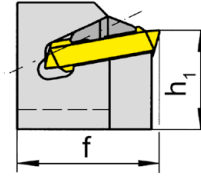
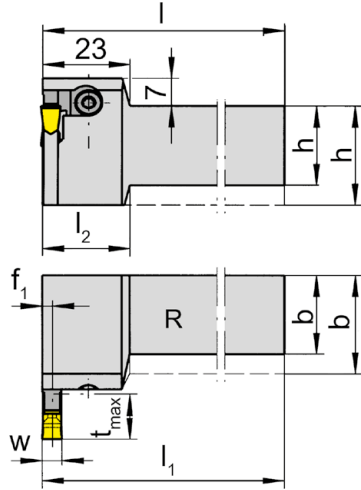
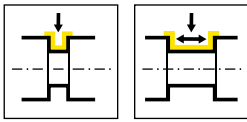

R = version à droite représentée
R = versione destra come in figura

L = version à gauche
L = versione sinistra a specchio

N° de commande Codice prodotto	h	b	l	l_1	l_2	h_1	f	f_1	t_{max}	HWS
R219.2020.09	20	20	150	$l-f_1+w/2$	23	25	45	4,8	15	229090 • 229091
R219.2525.09	25	25	150	$l-f_1+w/2$	-	25	45	4,8	15	229090 • 229091
L219.2020.09	20	20	150	$l-f_1+w/2$	23	25	45	4,8	15	229090 • 229091
L219.2525.09	25	25	150	$l-f_1+w/2$	-	25	45	4,8	15	229090 • 229091

w voir plaquettes amovibles
w vd. inserti

Pièces Détachées
Ricambi

Porte outils Portainsero	Bride Staffa	Tournevis TORX PLUS® Cacciavite TORX PLUS®
L219....	R218.9.32	T15PQ
R219....	L218.9.32	T15PQ

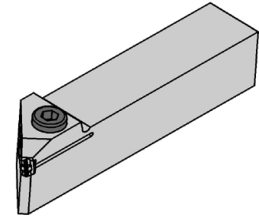
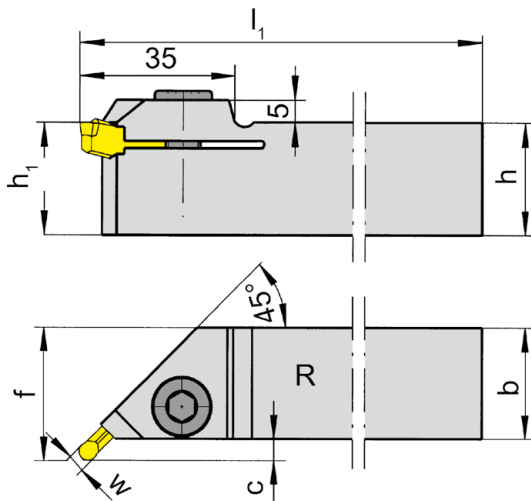
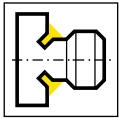

R = version à droite représentée
R = versione destra come in figura

L = version à gauche
L = versione sinistra a specchio

N° de commande Codice prodotto	h	b	l ₁	h ₁	f	C	D _{min}	Largueur de gorge Larghezza della gola	HWS
R225.2525.04	25	25	150	25	30	5	50	3,0-5,0	229040
R225.2525.05	25	25	150	25	30,5	5,5	50	5,1-6,0	229050 • 229051
L225.2525.04	25	25	150	25	30	5	50	3,0-5,0	229040
L225.2525.05	25	25	150	25	30,5	5,5	50	5,1-6,0	229050 • 229051

w voir plaquettes amovibles
w vd. inserti

Facteur de correction Δl_1 , Δc et Δf en fonction
du rayon r

Fattore di correzione Δl_1 , Δc e Δf in funzione del raggio r

r	Δl_1	Δc	Δf
2,5-3	0	0	0
2	-0,147	-0,147	-0,147
1,5	-0,293	-0,293	-0,293

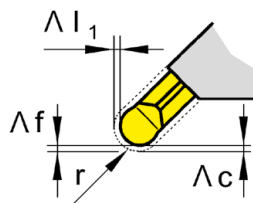

Pièces Détachées

Ricambi

Porte outils Portainsero	Vis de serrage Vite di serraggio
R/L225...	218.3

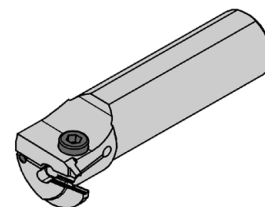
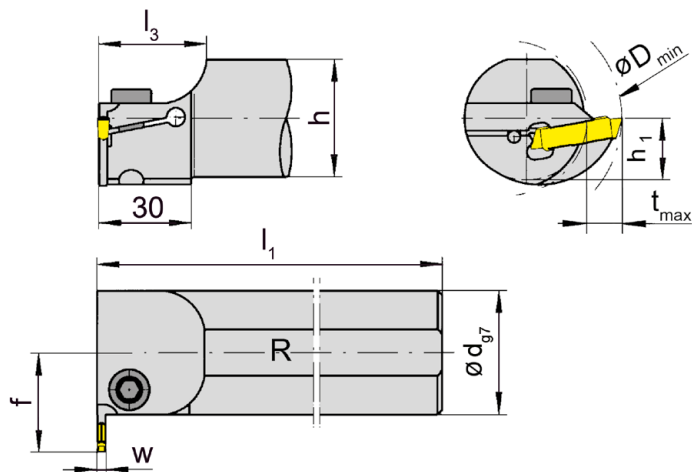
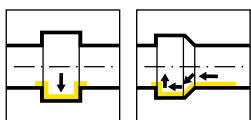

R = version à droite représentée
R = versione destra come in figura

L = version à gauche
L = versione sinistra a specchio

N° de commande Codice prodotto	d	l ₁	l ₃	h	h ₁	f	t _{max}	D _{min}	HWS
R213.0032.0.03	32	150	35	30	15	28	11,5	46	229030
R213.0040.0.03	40	180	39,4	38	19	32	11,5	54	229030
R213.0032.0.04	32	150	35	30	15	28	11,5	46	229040
R213.0040.0.04	40	180	39,4	38	19	32	11,5	54	229040
R213.0032.0.05	32	150	35	30	15	28	11,5	46	229051
R213.0040.0.05	40	180	39,4	38	19	32	11,5	54	229051
L213.0032.0.03	32	150	35	30	15	28	11,5	46	229030
L213.0040.0.03	40	180	39,4	38	19	32	11,5	54	229030
L213.0032.0.04	32	150	35	30	15	28	11,5	46	229040
L213.0040.0.04	40	180	39,4	38	19	32	11,5	54	229040
L213.0032.0.05	32	150	35	30	15	28	11,5	46	229051
L213.0040.0.05	40	180	39,4	38	19	32	11,5	54	229051

w voir plaquettes amovibles
w vd. inserti

Pièces Détachées

Ricambi

Porte outils Portainsero	Vis de serrage Vite di serraggio
R/L213...	218.3



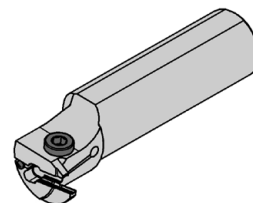
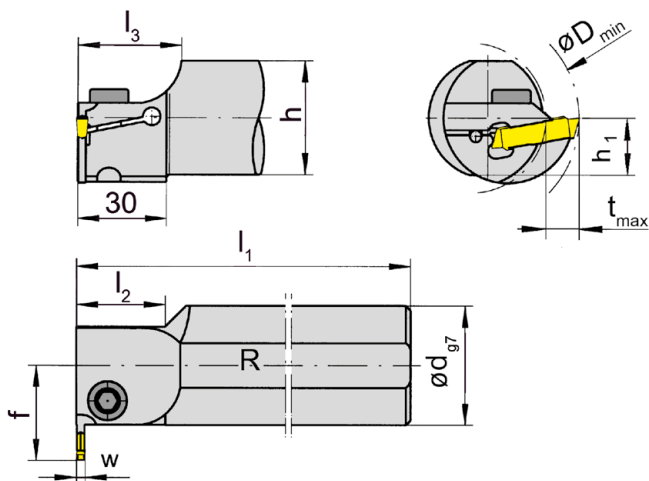
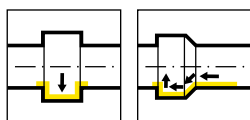

R = version à droite représentée
R = versione destra come in figura

L = version à gauche
L = versione sinistra a specchio

N° de commande Codice prodotto	d	l ₁	l ₂	l ₃	h	h ₁	f	t _{max}	D _{min}	HWS
R213.0025.03	25	150	-	31,8	23	11,5	24,5	7,5	38	229030
R213.0032.03	32	150	30	35	30	15	28	7,5	38	229030
R213.0040.03	40	180	30	37,4	38	19	32	11,5	50	229030
R213.0050.03	50	200	30	39,1	47	23,5	40,5	15	60	229030
R213.0025.04	25	150	-	31,8	23	11,5	24,5	7,5	38	229040
R213.0032.04	32	150	30	35	30	15	28	7,5	38	229040
R213.0040.04	40	180	30	37,4	38	19	32	11,5	50	229040
R213.0050.04	50	200	30	39,1	47	23,5	40,5	15	60	229040
R213.0032.05	32	150	-	35	30	15	28	11,5	46	229051
R213.0040.05	40	180	30	35	38	19	32	11,5	50	229051
R213.0050.05	50	200	30	40	47	23,5	40,5	15	60	229051
R213.0040.07	40	180	30	35	38	19	32	11,5	50	229070 • 229071
R213.0050.07	50	200	30	40	47	23,5	40,5	15	60	229070 • 229071
L213.0025.03	25	150	-	31,8	23	11,5	24,5	7,5	38	229030
L213.0032.03	32	150	30	35	30	15	28	7,5	38	229030
L213.0040.03	40	180	30	37,4	38	19	32	11,5	50	229030
L213.0050.03	50	200	30	39,1	47	23,5	40,5	15	60	229030
L213.0025.04	25	150	-	31,8	23	11,5	24,5	7,5	38	229040
L213.0032.04	32	150	-	35	30	15	28	7,5	38	229040
L213.0040.04	40	180	30	37,4	38	19	32	11,5	50	229040
L213.0050.04	50	200	30	39,1	47	23,5	40,5	15	60	229040
L213.0032.05	32	150	-	35	30	15	28	11,5	46	229051
L213.0040.05	40	180	30	35	38	19	32	11,5	50	229051
L213.0050.05	50	200	30	40	47	23,5	40,5	15	60	229051
L213.0040.07	40	180	30	35	38	19	32	11,5	50	229070 • 229071
L213.0050.07	50	200	30	40	47	23,5	40,5	15	60	229070 • 229071

w voir plaquettes amovibles
w vd. inserti

Le tmax = 11,5 mm sera atteint dans un Dmin 46 mm
La piena profondità di taglio tmax = 11,5 mm può essere raggiunta solo a partire da Dmin 46 mm

Pièces Détachées

Ricambi

Porte outils Portainserito	Vis de serrage Vite di serraggio
R/L213...	218.3

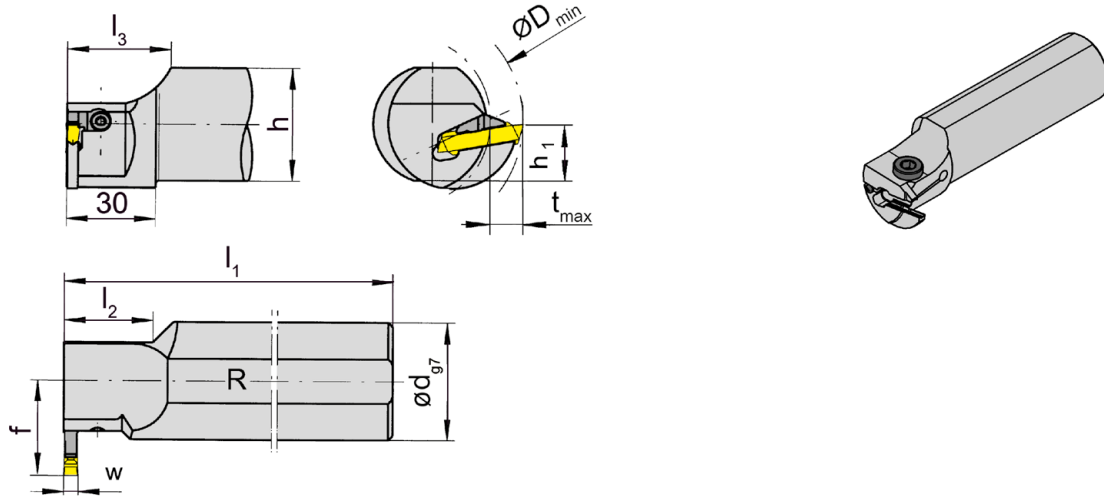
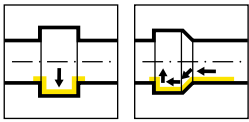

R = version à droite représentée
R = versione destra come in figura

L = version à gauche
L = versione sinistra a specchio

N° de commande Codice prodotto	d	l ₁	l ₂	l ₃	h	h ₁	f	t _{max}	D _{min}	HWS
R213.0040.09	40	180	30	35	38	19	32	11,5	50	229090 • 229091
R213.0050.09	50	200	30	40	47	23,5	40,5	15	60	229090 • 229091
L213.0040.09	40	180	30	35	38	19	32	11,5	50	229090 • 229091
L213.0050.09	50	200	30	40	47	23,5	40,5	15	60	229090 • 229091

w voir plaquettes amovibles
w vd. inserti

Pièces Détachées
Ricambi

Porte outils Portainsero	Bride Staffa	Tournevis TORX PLUS® Cacciavite TORX PLUS®
L213.0...	R218.9	T15PQ
R213.0...	L218.9	T15PQ



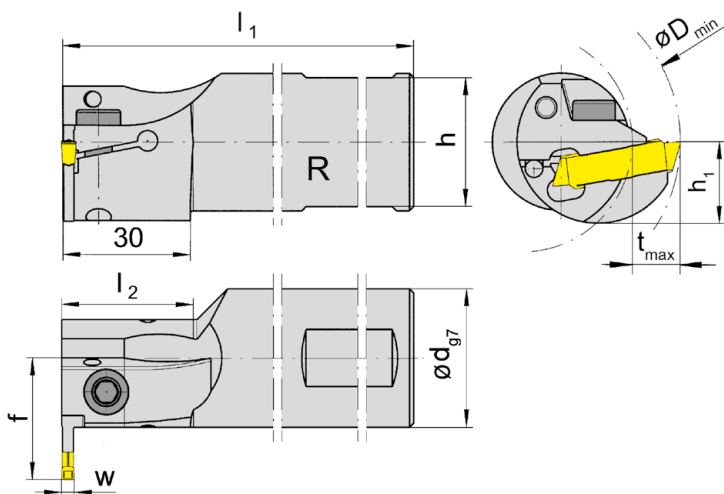
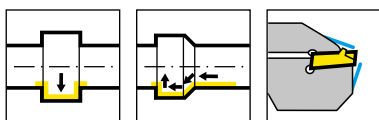

R = version à droite représentée
R = versione destra come in figura

L = version à gauche
L = versione sinistra a specchio

N° de commande Codice prodotto	d	l ₁	l ₂	h	h ₁	f	t _{max}	D _{min}	HWS
R213.0025.03IK	25	150	-	23	11,5	24,5	7,5	38	229030
R213.0025.04IK	25	150	-	23	11,5	24,5	7,5	38	229040
R213.0032.03IK	32	150	30	30	15	28	7,5	38	229030
R213.0032.04IK	32	150	30	30	15	28	7,5	38	229040
R213.0040.03IK	40	180	30	38	19	32	11,5	50	229030
R213.0040.04IK	40	180	30	38	19	32	11,5	50	229040
L213.0025.03IK	25	150	-	23	11,5	24,5	7,5	38	229030
L213.0025.04IK	25	150	-	23	11,5	24,5	7,5	38	229040
L213.0032.03IK	32	150	30	30	15	28	7,5	38	229030
L213.0032.04IK	32	150	30	30	15	28	7,5	38	229040
L213.0040.03IK	40	180	30	38	19	32	11,5	50	229030
L213.0040.04IK	40	180	30	38	19	32	11,5	50	229040

w voir plaquettes amovibles
w vd. inserti

Selon porte outils avec Ø 25 ou 32 mm

Le t_{max} = 11,5 mm sera atteint dans un D_{min} 46 mm

Rif. portainsero con gambo Ø 25 o 32 mm

La piena profondità di taglio t_{max} = 11,5 mm può essere raggiunta solo a partire da D_{min} 46 mm

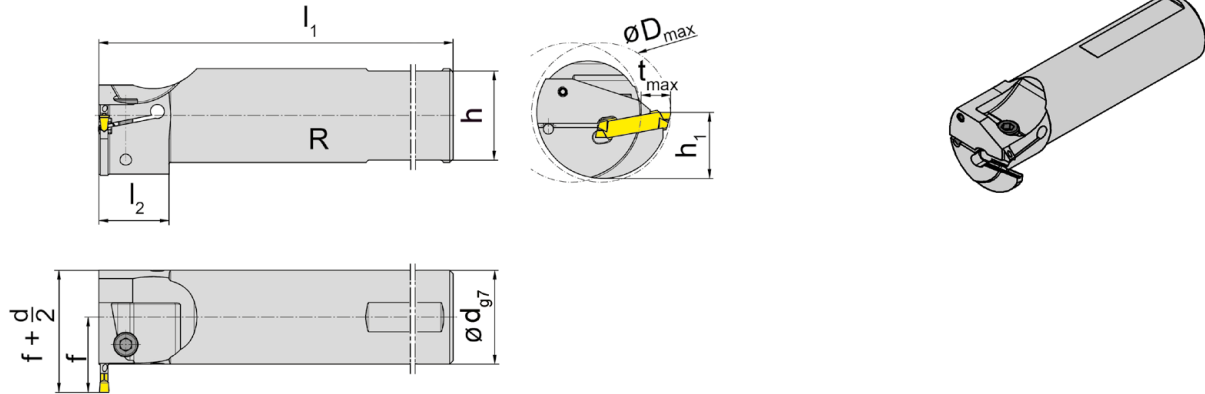
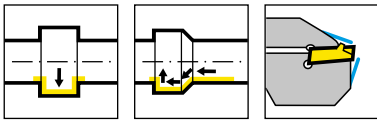

R = version à droite représentée
R = versione destra come in figura

L = version à gauche
L = versione sinistra a specchio

N° de commande Codice prodotto	d	l ₁	l ₂	h	h ₁	f	t _{max}	D _{min}	HWS
R213.0032.0.03IK	32	150	30	30	15	28	11,5	46	229030
R213.0032.0.04IK	32	150	30	30	15	28	11,5	46	229040
R213.0040.0.04IK	40	180	30	38	19	32	11,5	54	229040
R213.0040.0.05IK	40	180	30	38	19	32	11,5	54	229051
L213.0032.0.03IK	32	150	30	30	15	28	11,5	46	229030
L213.0032.0.04IK	32	150	30	30	15	28	11,5	46	229040
L213.0040.0.04IK	40	180	30	38	19	32	11,5	54	229040
L213.0040.0.05IK	40	180	30	38	19	32	11,5	54	229051

w voir plaquettes amovibles
w vd. inserti

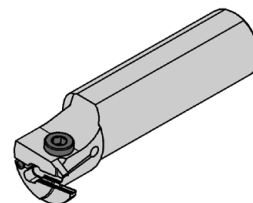
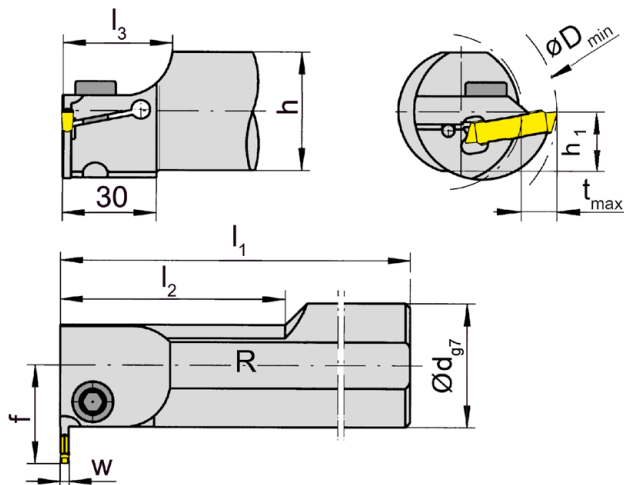
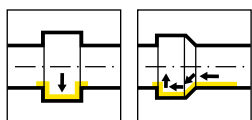

R = version à droite représentée
R = versione destra come in figura

L = version à gauche
L = versione sinistra a specchio

N° de commande Codice prodotto	d	l ₁	l ₂	l ₃	h	h ₁	f	t _{max}	D _{min}	HWS
R214.0032.03	32	200	70	35	30	15	28	7,5	38	229030
R214.0040.03	40	250	80	35	38	19	32	11,5	50	229030
R214.0050.03	50	250	100	40	47	23,5	40,5	15	60	229030
R214.0032.04	32	200	70	35	30	15	28	7,5	38	229040
R214.0040.04	40	250	80	35	38	19	32	11,5	50	229040
R214.0050.04	50	250	100	40	47	23,5	40,5	15	60	229040
R214.0032.05	32	200	-	35	30	15	28	11,5	46	229050 • 229051
R214.0040.05	40	250	80	35	38	19	32	11,5	50	229050 • 229051
R214.0050.05	50	250	100	40	47	23,5	40,5	15	60	229050 • 229051
R214.0040.07	40	250	80	35	38	19	32	11,5	50	229070 • 229071
R214.0050.07	50	250	100	40	47	23,5	40,5	15	60	229070 • 229071
L214.0032.03	32	200	70	35	30	15	28	7,5	38	229030
L214.0040.03	40	250	80	35	38	19	32	11,5	50	229030
L214.0050.03	50	250	100	40	47	23,5	40,5	15	60	229030
L214.0032.04	32	200	70	35	30	15	28	7,5	38	229040
L214.0040.04	40	250	80	35	38	19	32	11,5	50	229040
L214.0050.04	50	250	100	40	47	23,5	40,5	15	60	229040
L214.0032.05	32	200	-	35	30	15	28	11,5	46	229050 • 229051
L214.0040.05	40	250	80	35	38	19	32	11,5	50	229050 • 229051
L214.0050.05	50	250	100	40	47	23,5	40,5	15	60	229050 • 229051
L214.0040.07	40	250	80	35	38	19	32	11,5	50	229070 • 229071
L214.0050.07	50	250	100	40	47	23,5	40,5	15	60	229070 • 229071

w voir plaquettes amovibles
w vd. inserti

Selon porte outils avec Ø 25 ou 32 mm

Le tmax = 11,5 mm sera atteint dans un Dmin 46 mm

Rif. portainsero con gambo Ø 25 o 32 mm

La piena profondità di taglio tmax = 11,5 mm può essere raggiunta solo a partire da Dmin 46 mm

Pièces Détachées

Ricambi

Porte outils Portainsero	Vis de serrage Vite di serraggio
R/L214...	218.3

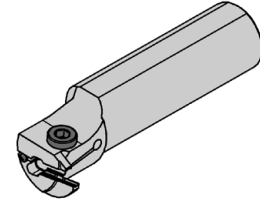
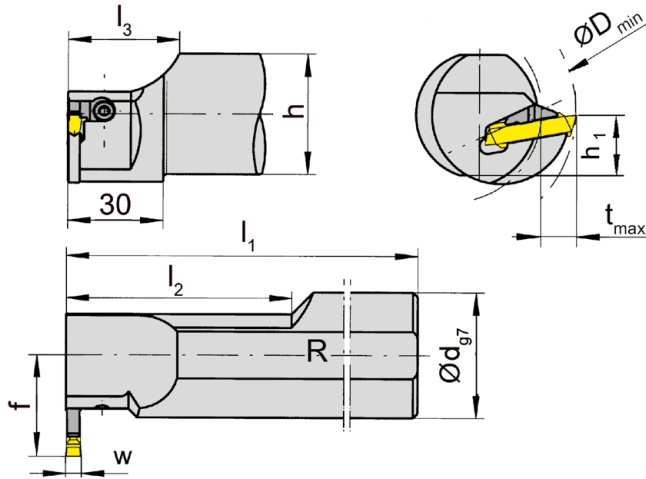
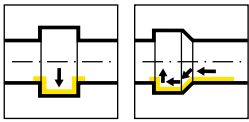

R = version à droite représentée
R = versione destra come in figura

L = version à gauche
L = versione sinistra a specchio

N° de commande Codice prodotto	d	l ₁	l ₂	l ₃	h	h ₁	f	t _{max}	D _{min}	HWS
R214.0040.09	40	250	80	35	38	19	32	11,5	50	229090 • 229091
R214.0050.09	50	250	100	40	47	23,5	40,5	15	60	229090 • 229091
L214.0040.09	40	250	80	35	38	19	32	11,5	50	229090 • 229091
L214.0050.09	50	250	100	40	47	23,5	40,5	15	60	229090 • 229091

w voir plaquettes amovibles
w vd. inserti

Pièces Détachées
Ricambi

Porte outils Portainsero	Bride Staffa	Tournevis TORX PLUS® Cacciavite TORX PLUS®
L214.0...	R218.9	T15PQ
R214.0...	L218.9	T15PQ

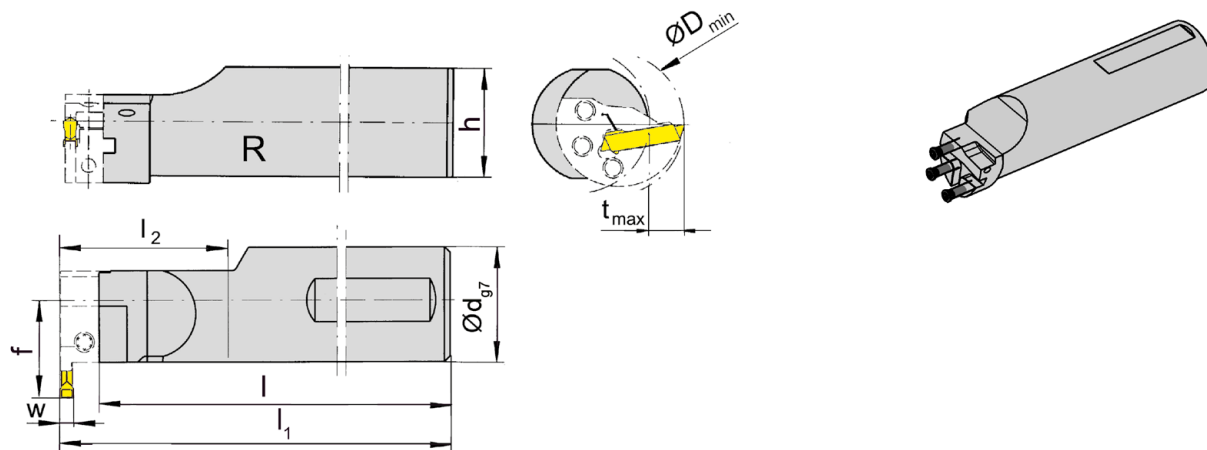
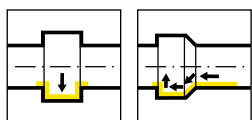

R = version à droite représentée
R = versione destra come in figura

L = version à gauche
L = versione sinistra a specchio

N° de commande Codice prodotto	d	l	l ₂	h	f	HWS
RB229.0040.1.K2	40	172,5	30	38	35,5	BK2291
RB229.0040.2.K2	40	185,5	60	38	35,5	BK2291
LB229.0040.1.K2	40	172,5	30	38	35,5	BK2292
LB229.0040.2.K2	40	185,5	60	38	35,5	BK2292

w voir plaquettes amovibles
w vd. inserti

Dimensions pour Dmin, tmax et b1 voir cassettes
Per le dimensioni Dmin, tmax e b1 vd. sezione cartucce

Note:

pour cassettes BK229 **sans** arrosage interne

Nota:

per cartucce BK229 senza lubrorefrigerante

Pièces Détachées

Ricambi

Base de support Attacco Base	Vis de serrage Vite di serraggio	Tournevis TORX PLUS® Cacciavite TORX PLUS®
R/LB229...	030.0518.T20P	T20PQ

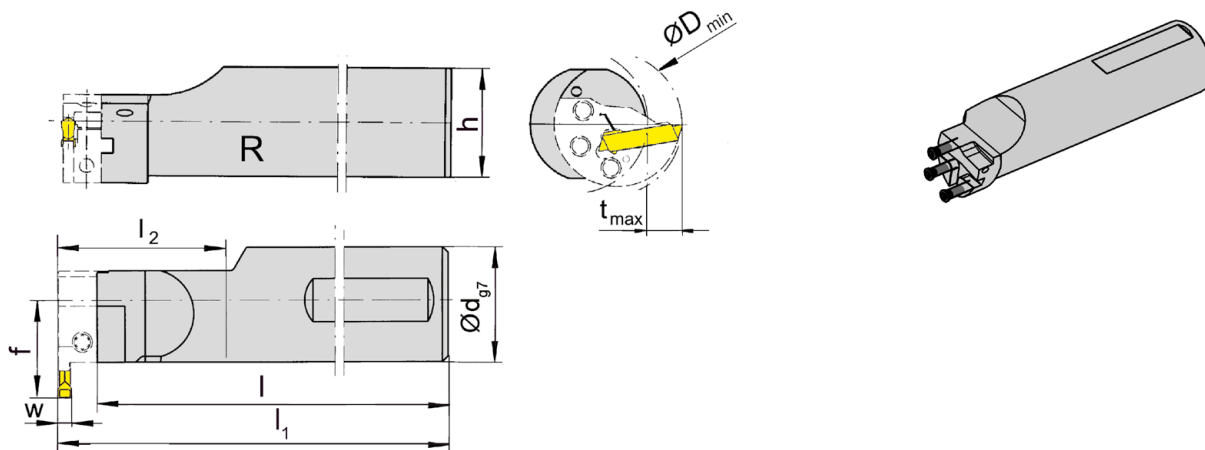
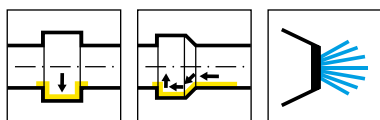

R = version à droite représentée
R = versione destra come in figura

L = version à gauche
L = versione sinistra a specchio

N° de commande Codice prodotto	d	l	l ₂	h	f	HWS
RB229.0040.1.K2.IK	40	172,5	30	38	35,5	BK2291
RB229.0040.2.K2.IK	40	185,5	60	38	35,5	BK2291
LB229.0040.1.K2.IK	40	172,5	30	38	35,5	BK2292
LB229.0040.2.K2.IK	40	185,5	60	38	35,5	BK2292

w voir plaquettes amovibles
w vd. inserti

Note:
pour cassettes BK229 avec arrosage interne

Nota:
per cartucce BK229 con lubrorefrigerante

H

Pièces Détachées

Ricambi

Base de support Attacco Base	Vis de serrage Vite di serraggio	Tournevis TORX PLUS® Cacciavite TORX PLUS®
R/LB229...	030.0518.T20P	T20PQ

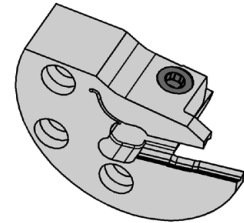
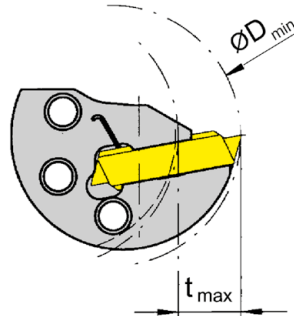
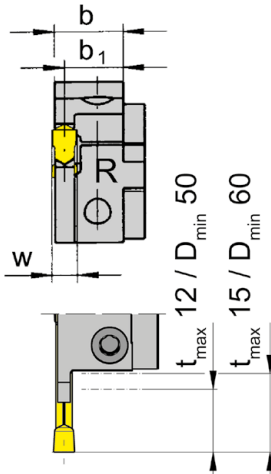
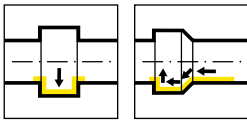

R = version à droite représentée
R = versione destra come in figura

L = version à gauche
L = versione sinistra

N° de commande Codice prodotto	b	b ₁	HWS	HMS
RBK229.0050.03	14,25	13	229030	BK2291
RBK229.0050.04	14,2	12,5	229040	BK2291
RBK229.0050.05	13,85	11,5	229050 • 229051	BK2291
LBK229.0050.03	14,25	13	229030	BK2292
LBK229.0050.04	14,2	12,5	229040	BK2292
LBK229.0050.05	13,85	11,5	229050 • 229051	BK2292

w voir plaquettes amovibles
w vd. inserti

Note:
pour base du support B229 **sans** arrosage interne

Nota:
per attacco base B229 senza lubrorefrigerante

La vis de serrage est vendue avec le base de support.

La vite di bloccaggio è fornita col portainserito base - non va ordinata separatamente.

Profondeur de gorge selon le ø d'alésage
Profondità gola in funzione al ø del foro

Dmin	tmax
50	12
60	15

Pièces Détachées

Ricambi

Cassette Cartuccia	Vis de serrage Vite di serraggio	Tournevis TORX PLUS® Cacciavite TORX PLUS®
R/LBK229...	5.13T20EP	T20PQ

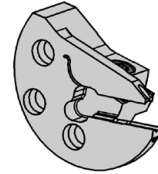
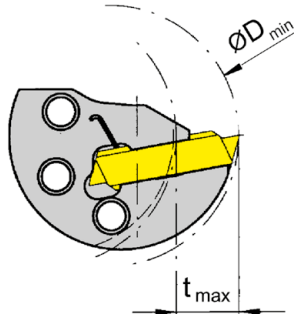
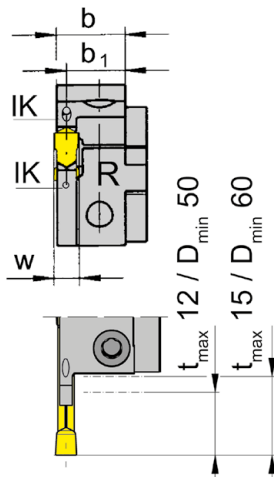
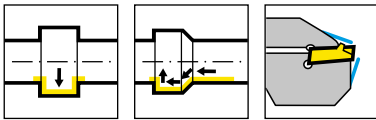

R = version à droite représentée
R = versione destra come in figura

L = version à gauche
L = versione sinistra

N° de commande Codice prodotto	b	b ₁	HWS	HMS
RBK229.0050.03.IK	14,2	13	229030	BK2291
RBK229.0050.04.IK	14,15	12,5	229040	BK2291
RBK229.0050.05.IK	13,8	11,5	229050 • 229051	BK2292
LBK229.0050.03.IK	14,2	13	229030	BK2292
LBK229.0050.04.IK	14,15	12,5	229040	BK2292
LBK229.0050.05.IK	13,8	11,5	229050 • 229051	BK2292

w voir plaquettes amovibles
w vd. inserti

Note:

pour base du support B229 avec arrosage interne

Nota:

per attacco base B224 con lubrorefrigerante

La vis de serrage est vendue avec le base de support.

La vite di bloccaggio è fornita col portainserito base - non va ordinata separatamente.

Profondeur de gorge selon le ø d'alésage

Profondità gola in funzione al ø del foro

Dmin	tmax
50	12
60	15

Pièces Détachées

Ricambi

Cassette Cartuccia	Vis de serrage Vite di serraggio	Tournevis TORX PLUS® Cacciavite TORX PLUS®
R/LBK229.0050...	5.13T20EP	T20PQ

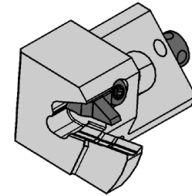
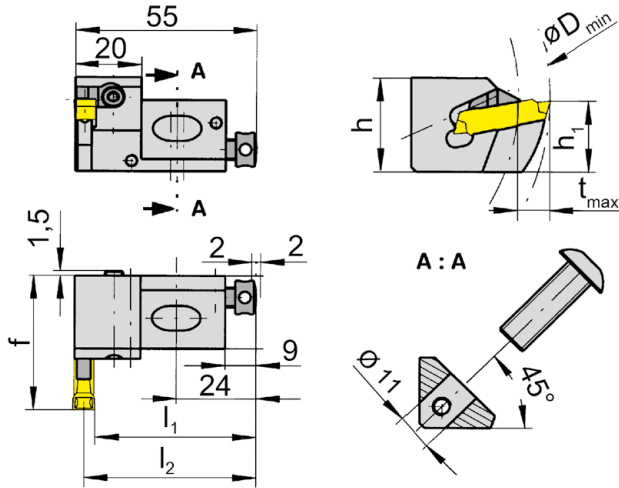
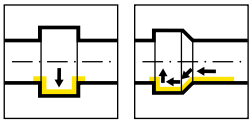

R = version à droite représentée
R = versione destra come in figura

L = version à gauche
L = versione sinistra a specchio

N° de commande Codice prodotto	h	h ₁	f	l ₂	l ₁
R257.2222.05	29	22	42	52,2	l ₂ -w/2
R257.2222.07	29	22	42	51,2	l ₂ -w/2
R257.2222.09	29	22	42	50,2	l ₂ -w/2
L257.2222.05	29	22	42	52,2	l ₂ -w/2
L257.2222.07	29	22	42	51,2	l ₂ -w/2
L257.2222.09	29	22	42	50,2	l ₂ -w/2

w voir plaquettes amovibles
w vd. inserti

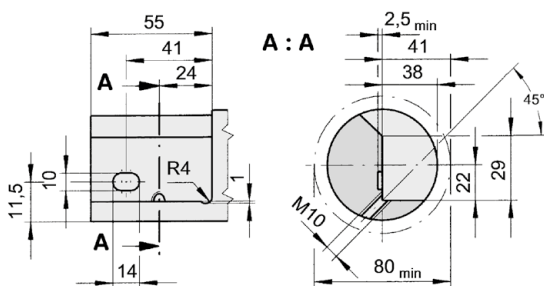

Pièces Détachées

Ricambi

Cartouche Cartuccia	Vis de serrage Vite di serraggio	Vis Vite	Bride Staffa	Tournevis TORX PLUS® Cacciavite TORX PLUS®
R/L257.2222.05	218.3	6.12.020		
R/L257.2222.07	4.08.913	6.12.020	R218.5.7.32	T15PQ
R/L257.2222.09	4.08.913	6.12.020	R218.9.32	T15PQ

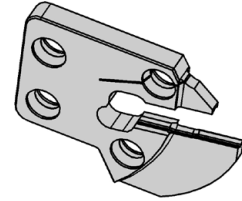
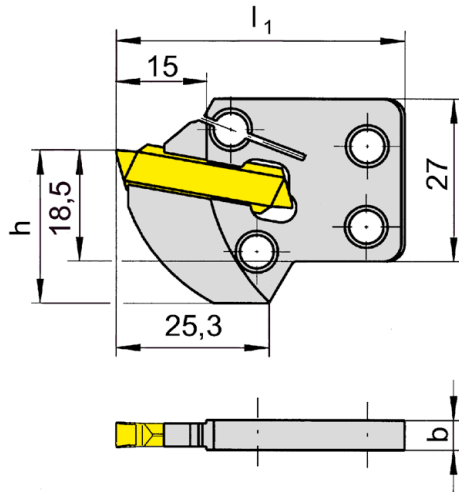
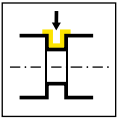

N° de commande Codice prodotto	D _{min}	D _{min 2}	t _{max}	b	l ₁	h	HWS	HMS
050.1827.0009	62	80	10-14	4,9	47	18,5	229040	500000
050.1827.0071	62	80	10-14	4,9	47	18,5	229030	500000

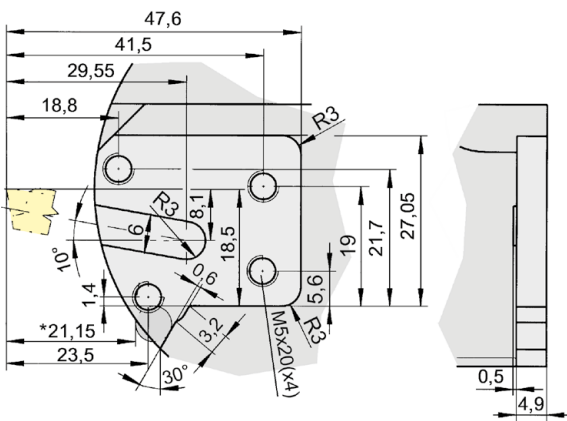

*Côte mesure pour $\varnothing 6$ mm
Su spina di riferimento $\varnothing 6$ mm



Plaquette amovible

Inserto

S229

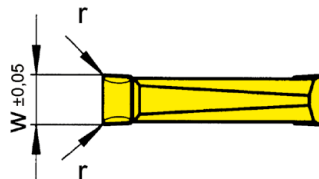
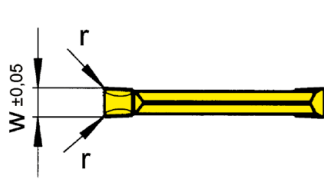
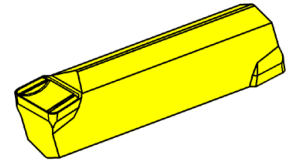
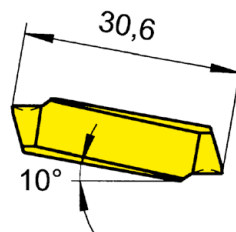
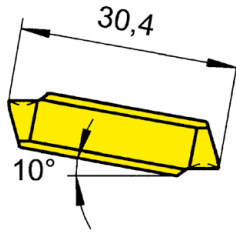
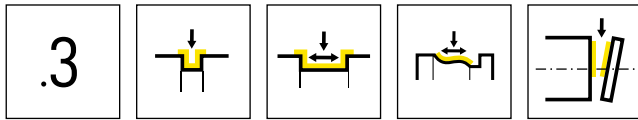

Largueur 3 - 5 mm
Larghezza 3 - 5 mm

Largueur 6 - 10 mm
Larghezza 6 - 10 mm

Nuance
Leghe
▲ en stock
a stock
Δ 4 semaines
4 settimane

N° de commande Codice prodotto	w	r	HIS	MG12	P20	AL96	AS62	AS66	H54	IG66	TA45	TC92	TF42	TF45	TI22	TI25	TN32	TN35
S229.0300.32	3	0,2	229020 • 229030	▲	Δ	▲	▲	▲	▲	▲	Δ	▲		▲	▲	▲	▲	▲
S229.0300.34	3	0,4	229020 • 229030	Δ	Δ	▲	▲	▲	▲	▲	▲	▲		▲	Δ	▲	▲	▲
S229.0400.32	4	0,2	229030 • 229040	Δ	Δ	▲	▲	▲	▲	▲	Δ	▲		▲		▲	▲	▲
S229.0400.34	4	0,4	229030 • 229040	Δ	Δ	▲	▲	▲	▲	▲	▲	▲	▲	▲	Δ	▲	▲	▲
S229.0500.34	5	0,4	229040	Δ	Δ	▲	▲	▲	Δ	▲	Δ	▲		▲	▲	▲	▲	▲
S229.0500.36	5	0,6	229040		Δ				Δ	▲		Δ			Δ	Δ	Δ	Δ
S229.0600.34	6	0,4	229051	Δ	Δ	▲	▲	▲	Δ	▲	Δ	Δ		▲	Δ	▲	▲	▲
S229.0600.38	6	0,8	229051			▲	▲	▲		▲		▲			Δ			
S229.0700.36	7	0,6	229071	Δ	Δ	Δ	▲			▲		Δ				▲	Δ	▲
S229.0800.36	8	0,6	229071 • 229081	Δ	Δ		▲			▲		▲			▲	▲	▲	▲
S229.0800.38	8	0,8	229071 • 229081							▲		Δ					Δ	
S229.0800.3K	8	1,2	229071 • 229081							▲		Δ			Δ			
S229.1000.36	10	0,6	229091	Δ	Δ		▲			▲		Δ				▲	▲	▲
P	O	●	●	●	●	●	●	●	●	●	●	●	●	●	●	●	●	●
M	-	-	-	-	O	-	-	-	●	●	●	-	-	●	-	●	-	●
K	-	-	●	-	●	-	●	-	-	-	●	-	-	●	-	●	-	●
N	-	-	●	-	●	-	-	-	-	-	●	-	-	●	-	●	-	●
S	-	-	-	-	O	-	O	-	O	●	●	-	-	●	-	●	-	●
H	-	-	-	-	-	-	-	-	-	-	-	-	-	-	-	-	-	-

H

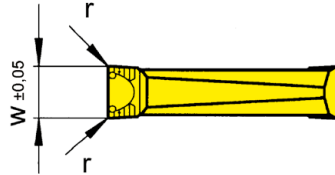
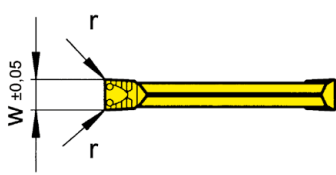
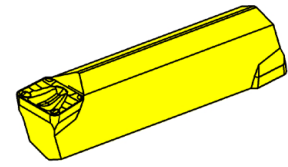
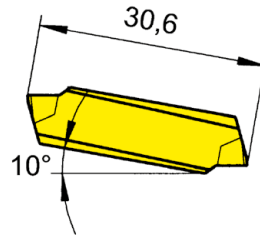
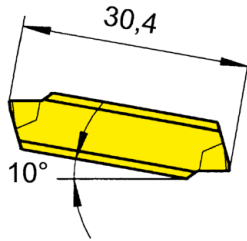
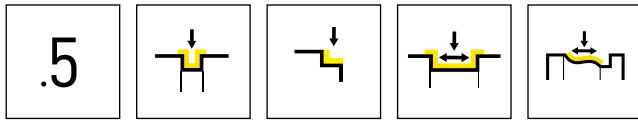

Largueur 3 - 5 mm
Larghezza 3 - 5 mm

Largueur 6 - 10 mm
Larghezza 6 - 10 mm

Nuance
Leghe
▲ en stock
a stock
Δ 4 semaines
4 settimane

N° de commande Codice prodotto	w	r	HIS	P20	AL96	AS62	AS65	IG66	TC92	TF42	TF45	TI22	TI25	TN32	TN35
S229.0300.52	3	0,2	229020 • 229030	Δ		▲		▲	Δ		▲	▲	▲	▲	▲
S229.0300.54	3	0,4	229020 • 229030		Δ	▲		▲	Δ		▲	▲	▲	▲	▲
S229.0400.52	4	0,2	229030 • 229040	Δ	Δ	▲		▲	Δ		▲	▲	▲	▲	▲
S229.0400.54	4	0,4	229030 • 229040		Δ	▲		▲			▲	▲	▲	▲	▲
S229.0500.54	5	0,4	229040	Δ	Δ	▲		▲	▲		▲	▲	▲	▲	▲
S229.0500.56	5	0,6	229040					▲	Δ				Δ	Δ	Δ
S229.0600.54	6	0,4	229051	Δ	Δ	▲		▲	▲		▲		▲	▲	▲
S229.0600.56	6	0,6	229051		Δ			▲	Δ				Δ	Δ	Δ
S229.0600.58	6	0,8	229051			▲	Δ	▲							
S229.0700.56	7	0,6	229071	Δ		▲			Δ			▲		Δ	
S229.0800.56	8	0,6	229071 • 229081	Δ		▲		Δ	Δ			▲		▲	
S229.0800.58	8	0,8	229071 • 229081	Δ	Δ				Δ	Δ		Δ		Δ	
S229.0800.5K	8	1,2	229071 • 229081		Δ				Δ			Δ			
S229.1000.56	10	0,6	229091	Δ	Δ				Δ			▲		▲	
P	●	●	●	●	●	●	●	●	●	●	●	●	●	●	●
M	-	-	-	○	●	-	-	-	-	-	●	-	●	-	●
K	-	●	-	○	-	-	-	-	-	-	●	-	●	-	●
N	-	●	-	-	-	-	-	-	-	-	●	-	●	-	●
S	-	-	-	-	○	-	-	-	-	-	●	-	●	-	●
H	-	-	-	-	-	-	-	-	-	-	-	-	-	-	-



Plaquette amovible

Inserto

S229

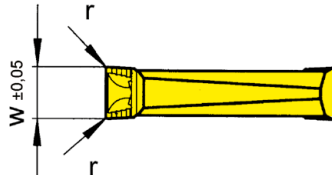
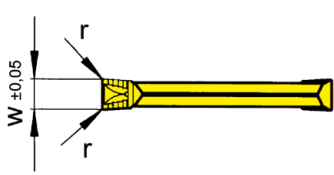
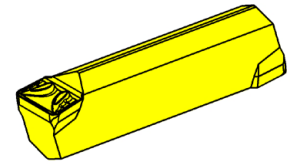
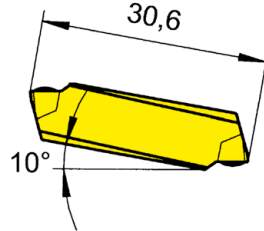
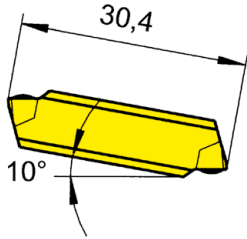
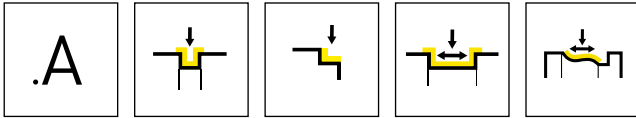

Largeur 3 - 5 mm
Larghezza 3 - 5 mm

Largeur 6 - 10 mm
Larghezza 6 - 10 mm

Nuance
Leghe
▲ en stock
a stock
Δ 4 semaines
4 settimane

N° de commande Codice prodotto	w	r	HIS	P20	AL96	AS62	IG66	TC92	TF42	TF45	TI22	TI25	TN32	TN35
				S229.0300.A2	3	0,2	229020 • 229030	Δ	Δ	▲		Δ		▲
S229.0300.A4	3	0,4	229020 • 229030		Δ	▲				▲	Δ	▲	▲	▲
S229.0400.A2	4	0,2	229030 • 229040	Δ	Δ	▲		Δ		▲	Δ	▲	▲	▲
S229.0400.A4	4	0,4	229030 • 229040		Δ	▲		Δ	▲	Δ	▲	▲	▲	▲
S229.0500.A4	5	0,4	229040			▲	▲	Δ		Δ	▲	Δ	▲	▲
S229.0500.A6	5	0,6	229040		Δ	▲	▲	Δ				▲		
S229.0600.A4	6	0,4	229051	Δ		▲			Δ	▲	▲	Δ	▲	▲
S229.0600.A8	6	0,8	229051			▲			Δ					
S229.0700.A6	7	0,6	229071					Δ	▲					Δ
S229.0800.A6	8	0,6	229071 • 229081				Δ		Δ		▲			▲
S229.0800.A8	8	0,8	229071 • 229081				Δ		Δ		Δ			
S229.0800.AK	8	1,2	229071 • 229081								Δ			
S229.1000.A6	10	0,6	229091	Δ			Δ				Δ		Δ	
S229.1000.A8	10	0,8	229091								Δ			
P	●	●	●	●	●	●	●	●	●	●	●	●	●	●
M	-	-	-	●	-	-	-	-	●	-	-	●	-	●
K	-	●	-	-	-	-	-	-	-	●	-	●	-	●
N	-	●	-	-	-	-	-	-	-	●	-	●	-	●
S	-	-	-	○	-	-	-	-	-	●	-	●	-	●
H	-	-	-	-	-	-	-	-	-	-	-	-	-	-

H

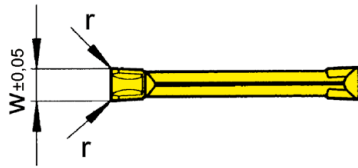
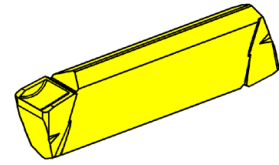
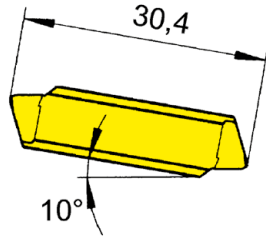
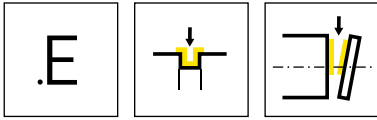

Nuance
Leghe

▲ en stock
a stock

Δ 4 semaines
4 settimane

N° de commande Codice prodotto	w	r	HIS	AS62	TC92	TF45	TF46	TI25
S229.0300.E2	3	0,2	229020 • 229030	▲		▲	▲	▲
S229.0300.E4	3	0,4	229020 • 229030	▲	Δ	▲		
S229.0400.E2	4	0,2	229030 • 229040	▲	Δ	▲	Δ	▲
S229.0400.E4	4	0,4	229030 • 229040	▲	Δ	▲		
P	●	●	●	●	●	●	●	●
M	-	-	●	○	●			
K	-	-	●	●	●			
N	-	-	●	●	●			
S	-	-	●	○	●			
H	-	-	-	-	-			



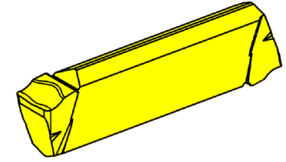
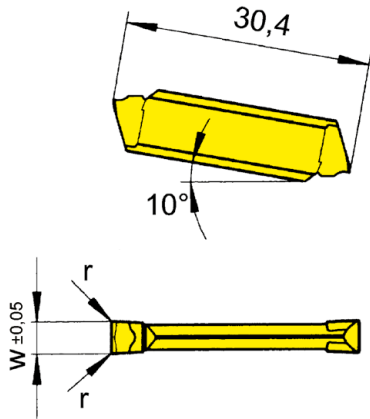
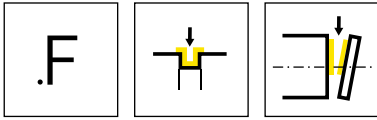

▲ en stock
a stock

Δ 4 semaines
4 settimane

Nuance
Leghe

N° de commande Codice prodotto	w	r	HIS	TC92	TF43	TF45	TF46	TI22	TI25
				▲	▲	▲	▲	▲	▲
S229.0300.F2	3	0,2	229020 • 229030	Δ	▲	▲	▲	▲	Δ
S229.0300.F4	3	0,4	229020 • 229030	Δ	Δ	▲	Δ	Δ	Δ
S229.0400.F2	4	0,2	229030 • 229040	Δ	Δ	▲	Δ	Δ	Δ
S229.0400.F4	4	0,4	229030 • 229040	Δ	Δ	▲	Δ	Δ	Δ
P				●	●	●	●	●	●
M				-	-	●	○	-	●
K				-	-	●	●	-	●
N				-	-	●	●	-	●
S				-	-	●	○	-	●
H				-	-	-	-	-	-

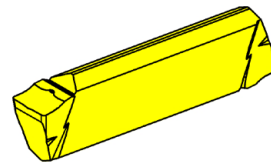
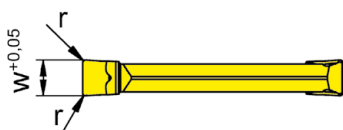
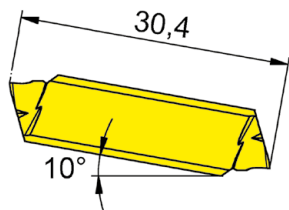
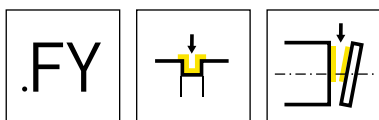

Nuance
Leghe

▲ en stock
a stock

Δ 4 semaines
4 settimane

N° de commande Codice prodotto	w	r	HIS	Nuance				
				HP65	IG35	PH35	TI25	
S229.0300.FY2	3	0,2	229020 • 229030	▲	▲	Δ	▲	
S229.0400.FY3	4	0,3	229030 • 229040	▲	▲	Δ	▲	
				P	●	-	○	●
				M	●	●	○	●
				K	●	-	●	●
				N	○	-	-	●
				S	●	●	-	●
				H	-	-	-	-



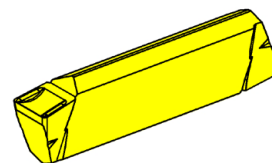
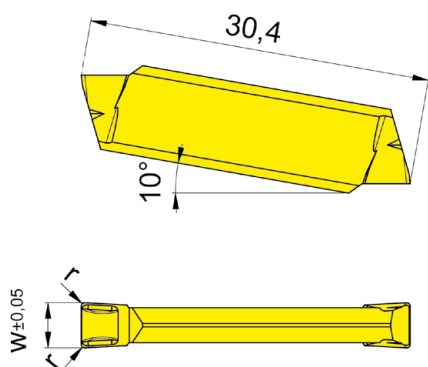
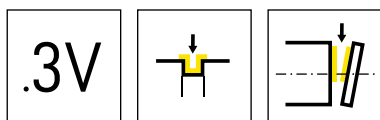

▲ en stock
a stock

▲ Nuance
Leghe

Δ 4 semaines
4 settimane

N° de commande Codice prodotto	w	r	HIS	Nuance Leghe		
				AS45	HP65	IG35
S229.0300.3V2	3	0,2	229020 • 229030	▲	▲	▲
S229.0400.3V3	4	0,3	229030 • 229040	▲	▲	▲
P	●	●	-	●	●	-
M	●	●	●	●	●	●
K	●	●	-	●	●	-
N	○	○	-	○	○	-
S	●	●	●	●	●	●
H	-	-	-	-	-	-

Plaquette amovible

Inserto

S229

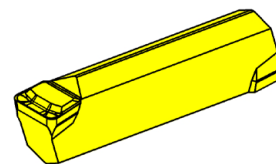
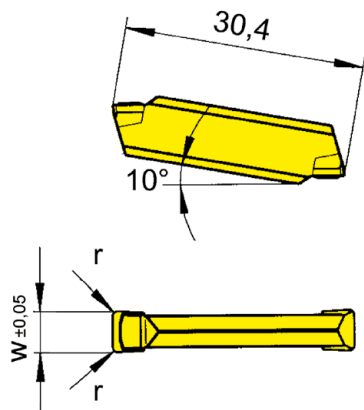
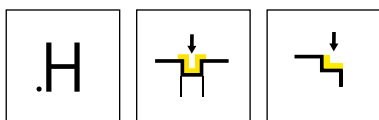

▲ en stock
a stock

△ 4 semaines
4 settimane

Nuance
Leghe

N° de commande Codice prodotto	w	r	HIS	AL96	TF42	TF46
S229.0300.H4	3	0,4	229020 • 229030	▲	△	
S229.0300.H6	3	0,6	229020 • 229030	▲	▲	
S229.0400.H4	4	0,4	229030 • 229040	△	▲	
S229.0400.H6	4	0,6	229030 • 229040	△	△	
S229.0400.H8	4	0,8	229030 • 229040	▲	▲	△
S229.0500.H4	5	0,4	229040	△	△	
S229.0500.H6	5	0,6	229040	△	△	
S229.0500.H8	5	0,8	229040	△	△	
S229.0600.H4	6	0,4	229051	△	▲	
S229.0600.H6	6	0,6	229051	△	△	
S229.0600.H8	6	0,8	229051	△	△	
S229.0600.HK	6	1,2	229051	△	△	
P				●	●	●
M				-	-	o
K				●	-	●
N				●	-	●
S				-	-	o
H				-	-	-



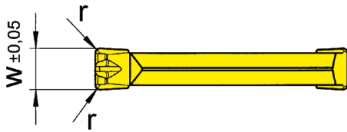
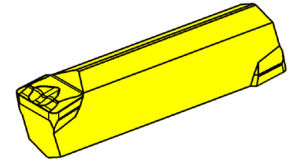
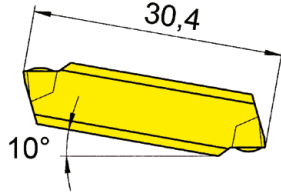
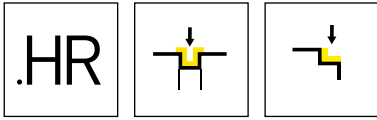

▲ en stock
a stock

△ 4 semaines
4 settimane

Nuance
Leghe

N° de commande Codice prodotto	w	r	HIS	Nuance Leghe		
				AS62	AS66	IG66
S229.0300.HR4	3	0,4	229020 • 229030	▲	△	▲
S229.0400.HR4	4	0,4	229030 • 229040	▲	▲	▲
S229.0500.HR4	5	0,4	229040	▲	▲	▲
S229.0500.HR6	5	0,6	229040	▲	▲	▲
S229.0500.HR8	5	0,8	229040	▲	△	▲
S229.0600.HR4	6	0,4	229050	▲	▲	▲
S229.0600.HR6	6	0,6	229050	▲	▲	▲
S229.0600.HR8	6	0,8	229050	▲	△	▲
S229.0800.HR8.PG	8	0,8	229071 • 229081	▲		▲
P	●	●	●			
M	-	○	●			
K	-	●	-			
N	-	●	-			
S	-	○	○			
H	-	-	-			

H

Plaquette amovible

Inserto

S229

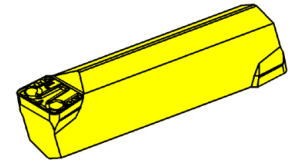
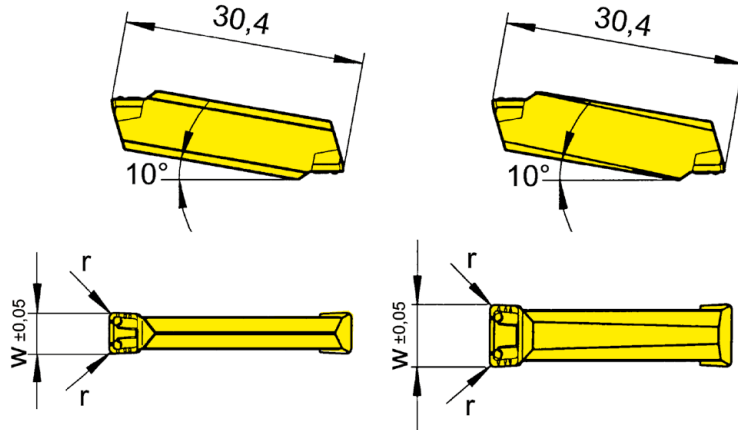
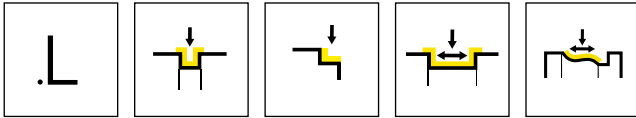

Largeur 4 - 5 mm
Larghezza 4 - 5 mm

Largeur 6 - 8 mm
Larghezza 6,0 - 8,0 mm

Nuance
Leghe
▲ en stock
a stock
Δ 4 semaines
4 settimane

N° de commande Codice prodotto	w	r	HIS	AL96	AS62	AS65	AS66	IG65	IG66	TF42	TI22
S229.0300.L6	3	0,6	229020 • 229030			▲		▲			
S229.0300.L8	3	0,8	229020 • 229030			▲		▲			
S229.0400.L4	4	0,4	229030 • 229040	▲	▲		▲		▲	▲	▲
S229.0400.L6	4	0,6	229030 • 229040				▲		▲	▲	▲
S229.0500.L4	5	0,4	229040	▲	▲		▲		▲	▲	▲
S229.0500.L6	5	0,6	229040	▲	▲		▲		▲	▲	▲
S229.0600.L4	6	0,4	229050	Δ	▲		▲		▲	▲	▲
S229.0500.L8	5	0,8	229040		▲		▲		▲	▲	▲
S229.0600.L6	6	0,6	229050	Δ	▲		▲		▲	▲	▲
S229.0800.L6	8	0,6	229071	▲	▲		▲		▲	▲	▲
P				●	●	●	●	●	●	●	●
M				-	-	○	○	●	●	-	-
K				●	-	○	●	-	-	-	-
N				●	-	-	●	-	-	-	-
S				-	-	-	○	○	○	-	-
H				-	-	-	-	-	-	-	-



Plaquette amovible

Inserto

S229

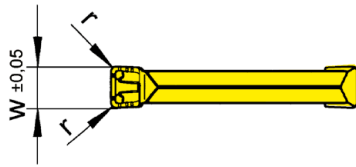
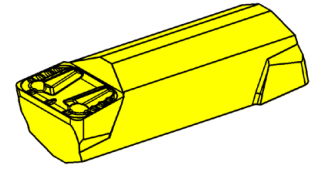
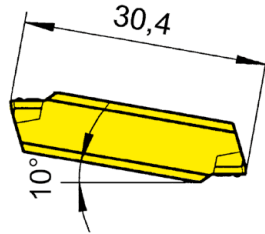
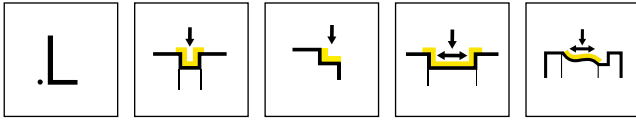

Nuance
Leghe

▲ en stock
a stock

Δ 4 semaines
4 settimane

N° de commande Codice prodotto	w	r	HIS	Nuance	
				AS62	IG66
S229.0600.L4.PG	6	0,4	229050	▲	▲
S229.0800.L8.PG	8	0,8	229071 • 229081	▲	▲
				P ● ●	
				M - ●	
				K - -	
				N - -	
				S - O	
				H - -	



Plaquette amovible

Inserto

S229

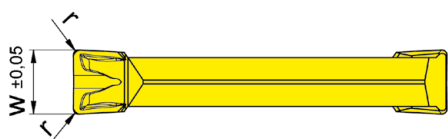
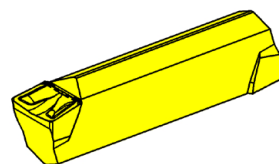
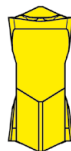
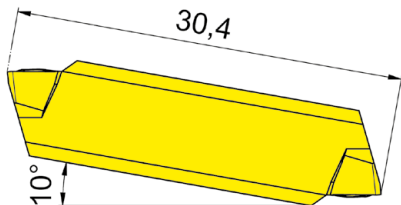
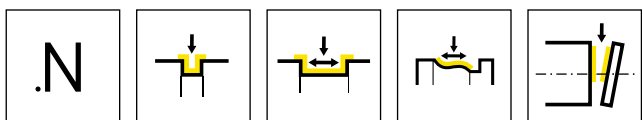

Nuance
Leghe

▲ en stock
a stock

Δ 4 semaines
4 settimane

N° de commande Codice prodotto	w	r	HIS	Nuance Leghe				
				AS45	AS62	DD25	IG66	TI25
S229.0300.N2.G	3	0,2	229020 • 229030	▲			▲	
S229.0300.N4.G	3	0,4	229020 • 229030	▲			▲	
S229.0400.N2.G	4	0,2	229030 • 229040	▲			▲	
S229.0400.N4.G	4	0,4	229030 • 229040	▲			▲	
S229.0500.N2.G	5	0,2	229040				▲	▲
S229.0500.N4.G	5	0,4	229040	▲	▲		▲	Δ
S229.0500.N6.G	5	0,6	229040	Δ	▲		▲	Δ
S229.0500.N8.G	5	0,8	229040		▲		▲	
S229.0600.N4.G	6	0,4	229050	▲			▲	Δ
S229.0600.N6.G	6	0,6	229050	▲			▲	Δ
P				●	●	-	●	●
M				●	-	-	●	●
K				●	-	-	-	●
N				○	-	●	-	●
S				●	-	○	○	●
H				-	-	-	-	-



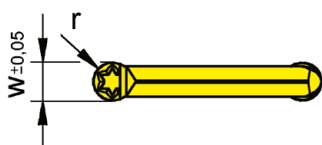
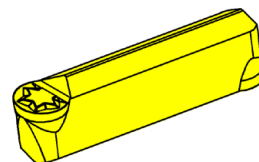
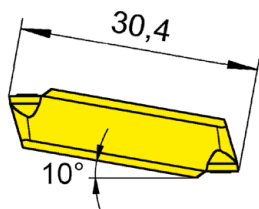
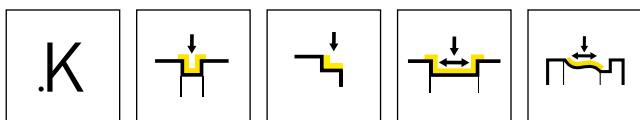

▲ en stock
a stock

△ 4 semaines
4 settimane

Nuance
Leghe

N° de commande Codice prodotto	w	r	HIS	Nuance Leghe		
				AS62	AS66	IG66
S229.0015.K3	3	1,5	229020 • 229030	▲	▲	▲
S229.0020.K4	4	2	229030 • 229040	▲	▲	▲
S229.0025.K5	5	2,5	229040	▲	▲	▲
S229.0030.K6	6	3	229050	▲	▲	▲
S229.0040.K8	8	4	229070 • 229080	▲	▲	▲
				P	•	•
				M	-	•
				K	-	-
				N	-	•
				S	-	•
				H	-	-

D_{min} pour rayon de dégagement avec porte outils à 45°

D_{min} per scarico di rettifica con portainsero 45°

t _{max}	S229.0015.K3	S229.0020.K4	S229.0025.K5	S229.0030.K6
0,5	Ø 26	Ø 26	Ø 32	Ø 32
1,0	Ø 76	Ø 55	Ø 42	Ø 37
1,5	Ø 78	Ø 58	Ø 45	Ø 41
2,0	Ø 80	Ø 59	Ø 46	Ø 42
2,5	Ø 82	Ø 60	Ø 47	Ø 43
3,0	Ø 84	Ø 62	Ø 48	Ø 44
3,5	Ø 87	Ø 63	Ø 49	Ø 46
4,0	Ø 89	Ø 65	Ø 50	Ø 47

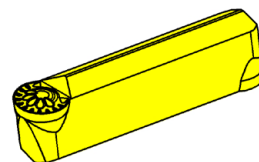
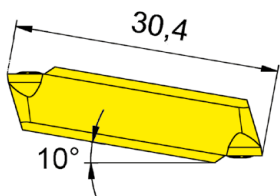
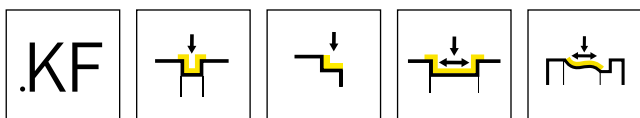

Nuance
Leghe

▲ en stock
a stock

Δ 4 semaines
4 settimane

N° de commande Codice prodotto	w	r	HIS	Nuance	
				AS66	IG66
S229.0015.KF3	3	1,5	229020 • 229030	▲	▲
S229.0020.KF4	4	2	229030 • 229040	▲	▲
S229.0025.KF5	5	2,5	229040	▲	▲
S229.0030.KF6	6	3	229050	▲	▲
S229.0040.KF8	8	4	229070 • 229080	▲	▲
				P ● ●	
				M ○ ●	
				K ● -	
				N ● -	
				S ○ ○	
				H - -	



D_{min} pour rayon de dégagement avec porte outils à 45°

D_{min} per scarico di rettifica con portainsero 45°

t _{max}	S229.0015.KF3	S229.0020.KF4	S229.0025.KF5	S229.0030.KF6
0,5	Ø 26	Ø 26	Ø 32	Ø 32
1,0	Ø 76	Ø 55	Ø 42	Ø 37
1,5	Ø 78	Ø 58	Ø 45	Ø 41
2,0	Ø 80	Ø 59	Ø 46	Ø 42
2,5	Ø 82	Ø 60	Ø 47	Ø 43
3,0	Ø 84	Ø 62	Ø 48	Ø 44
3,5	Ø 87	Ø 63	Ø 49	Ø 46
4,0	Ø 89	Ø 65	Ø 50	Ø 47

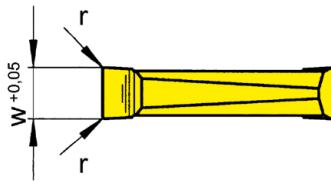
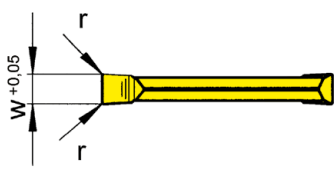
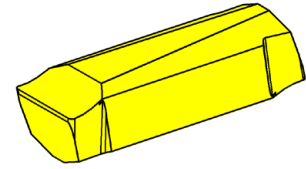
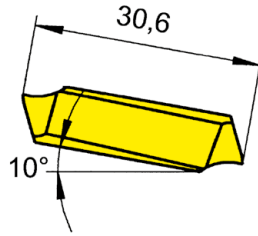
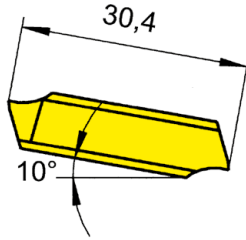
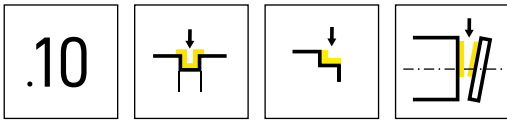

Largeur de gorge 2,5 - 5,0 mm
Larghezza della gola 2,5 - 5,0 mm

Largeur 5,1 - 10,4 mm
Larghezza 5,1 - 10,4 mm

Nuance
Leghe
▲ en stock
a stock
Δ 4 semaines
4 settimane

N° de commande Codice prodotto	w	r	HIS		K10	MG12	P20	AS62	IG66	TC92	TN32	TN35	H20	Nuance	
														▲	Δ
229.0250.10	2,5	0,2	229020						▲		▲	▲			
229.0300.10	3	0,2	229020 • 229030	▲	▲		▲	▲	▲	▲	▲	▲	▲	▲	
229.0400.10	4	0,2	229030 • 229040	▲		▲	▲	▲	▲	Δ	▲	Δ			
229.0500.10	5	0,2	229040	▲		▲	Δ	Δ	Δ	▲	▲	Δ			
229.0600.10	6	0,4	229051	Δ		Δ	Δ	Δ	Δ	Δ	Δ	Δ			
229.0700.10	7	0,4	229071	Δ		Δ	Δ	Δ	Δ	Δ	Δ	Δ			
229.0800.10	8	0,4	229071 • 229081	Δ		Δ	Δ	Δ	Δ	Δ	Δ	Δ			
229.0900.10	9	0,4	229091	Δ		Δ	Δ	Δ	Δ	Δ	Δ	Δ			
229.1000.10	10	0,4	229091	Δ		Δ	Δ	Δ	Δ	Δ	Δ	Δ			
				P	●	o	●	●	●	●	●	●	●	●	
				M	o	-	-	-	●	-	-	●	o		
				K	●	-	-	-	-	-	-	●	-		
				N	●	-	-	-	-	-	-	●	-		
				S	o	-	-	-	o	-	-	●	-		
				H	-	-	-	-	-	-	-	-	-		

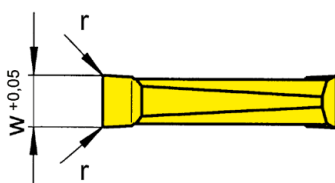
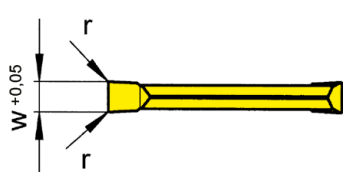
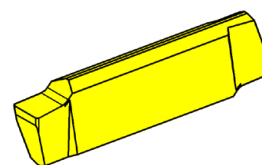
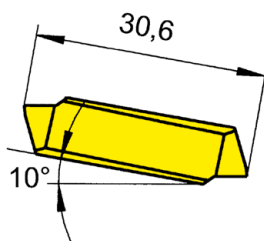
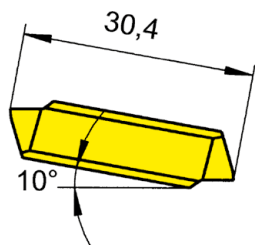
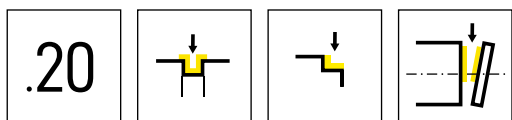

Largueur 3 - 5 mm
Larghezza 3 - 5 mm

Largueur 5,1 - 10,4 mm
Larghezza 5,1 - 10,4 mm

▲ en stock
a stock

Nuance
Leghe
Δ 4 semaines
4 settimane

N° de commande Codice prodotto	w	r	HIS		K10	AS62	IG66	TC92	TN32	H20	Nuance Leghe	
											▲ en stock a stock	Δ 4 semaines 4 settimane
229.0300.20	3	0,2	229020 • 229030	▲	▲	Δ	▲	▲		▲		
229.0400.20	4	0,2	229030 • 229040	▲	▲	Δ	Δ	Δ	▲			
229.0500.20	5	0,2	229040	▲	▲	Δ	▲					
229.0600.20	6	0,4	229051	▲	▲	Δ	Δ					
229.0700.20	7	0,4	229071	▲		Δ						
229.0800.20	8	0,4	229071 • 229081	▲		Δ						
229.0900.20	9	0,4	229091	Δ		Δ						
229.1000.20	10	0,4	229091	Δ		Δ						
				P	●	●	●	●	●	●		
				M	○	-	●	-	-	○		
				K	●	-	-	-	-	-		
				N	●	-	-	-	-	-		
				S	○	-	○	-	-	-		
				H	-	-	-	-	-	-		



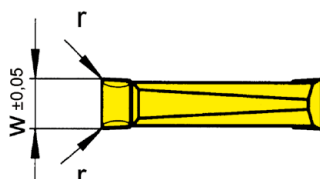
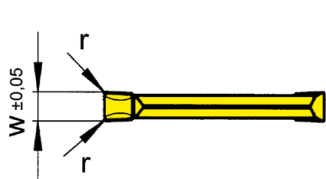
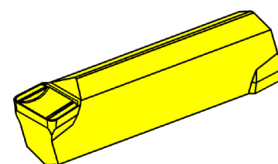
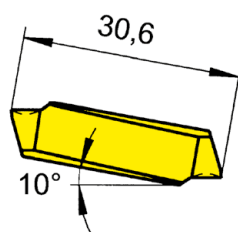
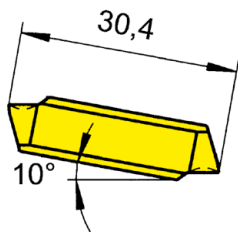
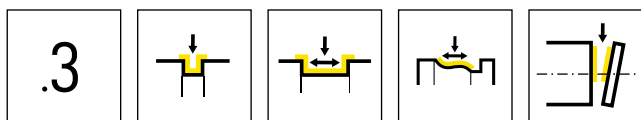

Largueur 3 - 5 mm
Larghezza 3 - 5 mm

Largueur 5,1 - 10,4 mm
Larghezza 5,1 - 10,4 mm

▲ en stock
a stock

Nuance
Leghe
Δ 4 semaines
4 settimane

N° de commande Codice prodotto	w	r	HIS	Nuance / Leghe									
				K10	MG12	P20	AS62	IG66	TC92	TI22	TI25	TN32	TN35
229.0300.31	3	0,2	229020 • 229030	▲	▲	▲	▲	▲	▲		▲	▲	▲
229.0300.34	3	0,4	229020 • 229030			Δ	▲	▲	Δ			▲	▲
229.0350.31	3,5	0,2	229030				▲	▲				▲	▲
229.0400.31	4	0,2	229030 • 229040	▲		▲	▲	▲	▲			▲	▲
229.0400.34	4	0,4	229030 • 229040			▲	▲	▲	Δ			▲	▲
229.0500.31	5	0,2	229040	▲		▲	▲	▲	Δ	▲		▲	▲
229.0500.34	5	0,4	229040			Δ	Δ	Δ	Δ			▲	▲
229.0500.36	5	0,6	229040					Δ	Δ			Δ	Δ
229.0600.31	6	0,4	229051			▲	Δ	Δ	▲			▲	▲
229.0600.38	6	0,8	229051				Δ	Δ	Δ			Δ	Δ
229.0700.31	7	0,4	229071			Δ	Δ	Δ	Δ			▲	▲
229.0800.31	8	0,4	229071 • 229081			▲	▲	Δ				▲	▲
229.0900.31	9	0,4	229091				Δ	▲	▲			▲	▲
229.1000.31	10	0,4	229091				Δ	Δ	Δ			▲	▲
P	●	○	●	●	●	●	●	●	●	●	●	●	●
M	○	-	-	-	●	-	-	-	●	-	-	●	●
K	●	-	-	-	-	-	-	-	-	-	-	-	●
N	●	-	-	-	-	-	-	-	-	-	●	-	●
S	○	-	-	-	○	-	-	-	-	-	●	-	●
H	-	-	-	-	-	-	-	-	-	-	-	-	-

H

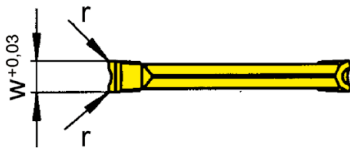
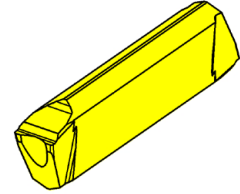
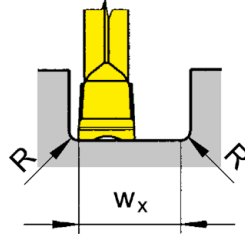
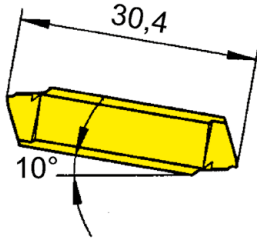
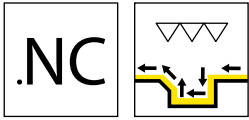

Nuance
Leghe
▲ en stock
a stock
Δ 4 semaines
4 settimane

N° de commande Codice prodotto	w	r	w _x	HIS	H20
229.NC30.02	3	0,2	4,5	229030 • 229040	▲
229.NC40.02	4	0,2	6,4	229030 • 229040	▲

wx = largeur de gorge - R(droite) - R(gauche)
wx = larghezza gola - R(destro) - R(sinistro)

P	●
M	○
K	-
N	-
S	-
H	-



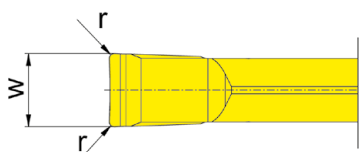
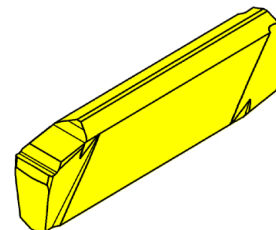
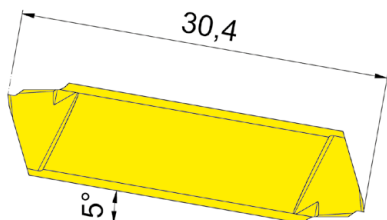
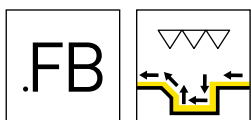

Nuance
Leghe

▲ en stock
a stock

Δ 4 semaines
4 settimane

N° de commande Codice prodotto	w	r	HIS	IG6T	H20
229.FB30.02	3	0,2	229030	Δ	▲
229.FB40.02	4	0,2	229040	Δ	▲
				P ● ●	
				M ● ●	
				K - -	
				N - -	
				S ● -	
				H - -	

Calcul de la plus petite largeur de gorge possible w_x
Calcolo della larghezza di gola w_x più basso possibile

Exemple 229.FB30.02
Esempio

$w_x = 2 \times \text{Largeur de gorge} / \text{Larghezza della gola } w - 2 \times \text{Rayon d'angles plaque} / \text{Spigolo raggiato inserto } r$

$w_x = 2 \times 3 \text{ mm} - 2 \times 0,2 \text{ mm}$

$w_x = 5,6 \text{ mm}$

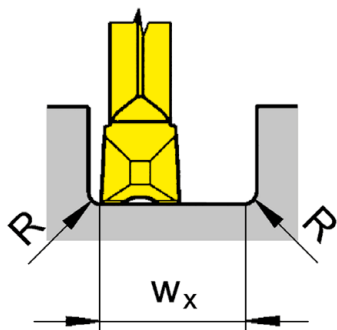

Déroulement du processus
Percorso di lavoro

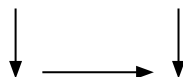

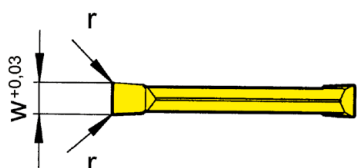
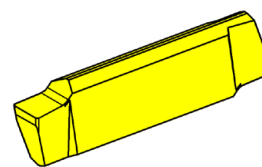
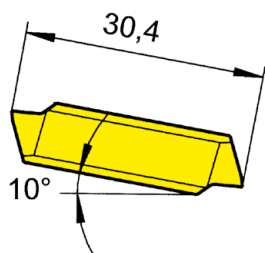
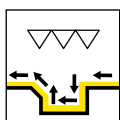

▲ en stock
a stock

Δ 4 semaines
4 settimane

Nuance
Leghe

N° de commande Codice prodotto	w	r	HIS	TN32	H20
				▲	▲
229.0300.02	3	0,2	229020 • 229030	▲	▲
229.0400.02	4	0,2	229030 • 229040	Δ	▲
				P ● ●	
				M - o	
				K - -	
				N - -	
				S - -	
				H - -	



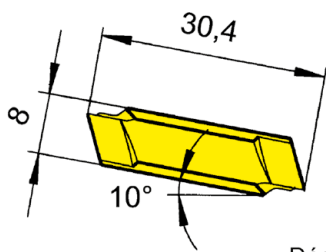
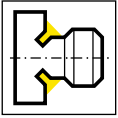

Contournage
Esecuzione di profili

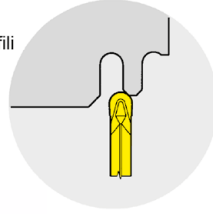

ou
o

Dégagement d'angle
Gole di sacarico ad angolo

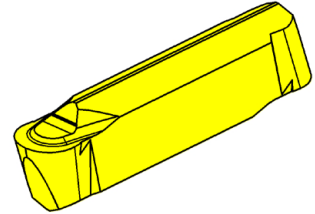
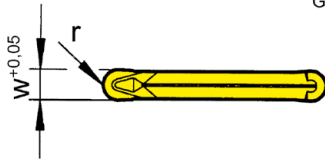
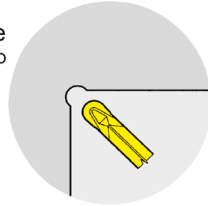

Nuance
Leghe

▲ en stock
a stock

Δ 4 semaines
4 settimane

N° de commande Codice prodotto	w	r	HIS	Nuance					
				MG12	P20	AS62	AS66	TN32	H20
229.0015.30	3	1,5	229020 • 229030	▲	▲	▲		▲	▲
229.0020.40	4	2	229030 • 229040	▲	▲	▲		▲	
229.0025.50	5	2,5	229040	▲	▲		▲	▲	
229.0030.60	6	3	229050		▲	▲		▲	
				P	O	●	●	●	●
				M	-	-	-	O	-
				K	-	-	-	●	-
				N	-	-	-	●	-
				S	-	-	-	O	-
				H	-	-	-	-	-

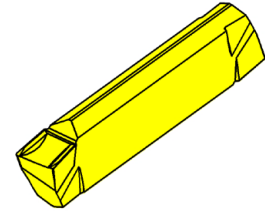
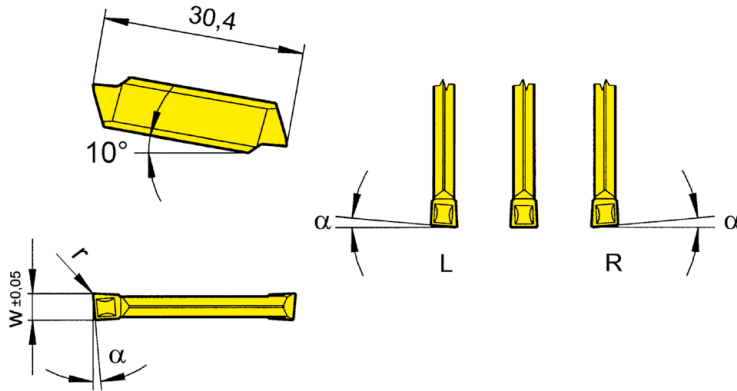
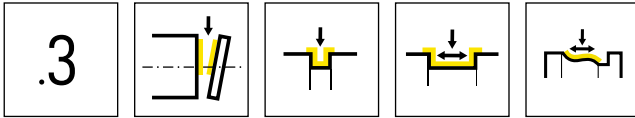

R = version à droite représentée
R = versione destra come in figura

L = version à gauche
L = versione sinistra a specchio

Nuance
Leghe
▲ en stock
a stock
Δ 4 semaines
4 settimane

N° de commande Codice prodotto	w	r	α	HIS	MG12	P20	AL96	AS62	AS66	H54	IG66	TA45	TC92	TF45	TI22	TI25	TN32	TN35
					▲	▲	▲	▲	▲	▲	▲	▲	▲	▲	▲	▲	▲	▲
R229.5300.31	3	0,2	5°	229020 • 229030	▲			▲					▲			▲	▲	▲
RS229.0530.32	3	0,2	5°	229020 • 229030				▲				Δ	▲	▲		▲	▲	▲
RS229.0540.32	4	0,2	5°	229030 • 229040				▲				Δ	Δ	▲		▲	▲	Δ
L229.5300.31	3	0,2	5°	229020 • 229030	▲			▲					▲			▲	▲	▲
LS229.0530.32	3	0,2	5°	229020 • 229030				▲				Δ	Δ	▲		▲	▲	▲
LS229.0540.32	4	0,2	5°	229030 • 229040								Δ	Δ	▲		▲	▲	Δ
S229.0300.32	3	0,2	-	229020 • 229030	▲	Δ	▲	▲	▲	▲	▲	Δ	▲	▲	▲	▲	▲	▲
S229.0400.32	4	0,2	-	229030 • 229040	Δ	Δ	▲	▲	▲	▲	▲	Δ	▲	▲		▲	▲	▲
R/L229.5300.31 précision affûtée, longueur 30,0 mm R/L229.5300.31 rettificato di precisione, lunghezza 30,0 mm					P	O	●	●	●	●	●	●	●	●	●	●	●	●
					M	-	-	-	O	●	●	●	-	●	-	●	-	●
					K	-	-	●	-	●	-	-	●	●	-	●	-	●
					N	-	-	●	-	●	-	-	●	-	-	●	-	●
					S	-	-	-	-	O	-	O	●	-	●	-	●	-
					H	-	-	-	-	-	-	-	-	-	-	-	-	-



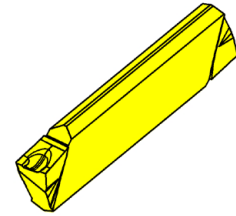
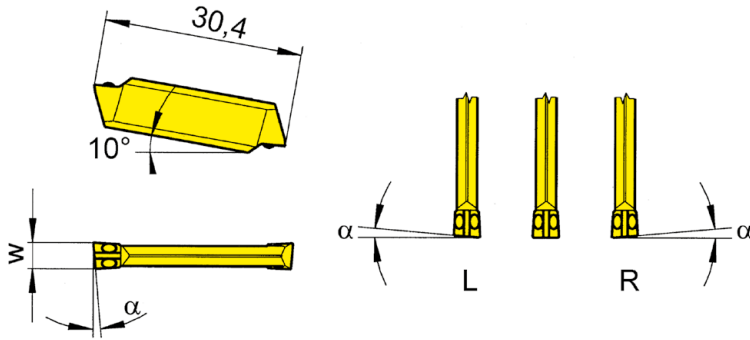
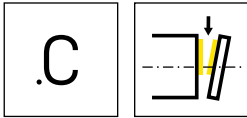

R = version à droite représentée
R = versione destra come in figura

L = version à gauche
L = versione sinistra a specchio

▲ en stock
a stock

Nuance
Leghe
Δ 4 semaines
4 settimane

N° de commande Codice prodotto	w	α	HIS	Nuance Leghe			
				TC92	TF45	TI25	TN35
RS229.0530.C0	3	5°	229020 • 229030	Δ	▲	▲	▲
RS229.0540.C0	4	5°	229030 • 229040	Δ	Δ	Δ	▲
RS229.0830.C0	3	8°	229020 • 229030	▲	▲	▲	▲
RS229.0840.C0	4	8°	229030 • 229040		Δ	Δ	▲
LS229.0530.C0	3	5°	229020 • 229030	Δ	▲	▲	▲
LS229.0540.C0	4	5°	229030 • 229040	Δ	Δ	Δ	
LS229.0830.C0	3	8°	229020 • 229030	▲	▲	▲	▲
LS229.0840.C0	4	8°	229030 • 229040	Δ	Δ	Δ	Δ
S229.0030.C0	3	0°	229020 • 229030	Δ	▲	▲	▲
S229.0040.C0	4	0°	229030 • 229040	Δ	Δ	Δ	▲
P				●	●	●	●
M				-	●	●	●
K				-	●	●	●
N				-	●	●	●
S				-	●	●	●
H				-	-	-	-

H

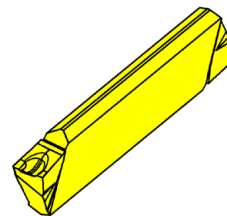
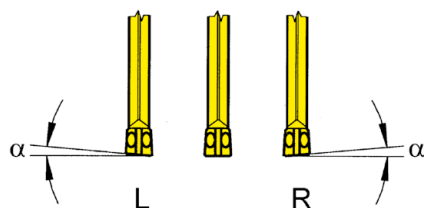
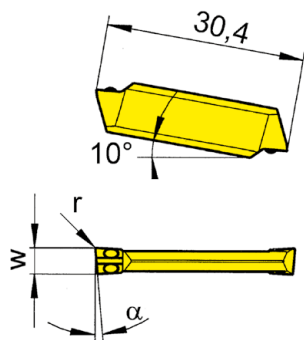
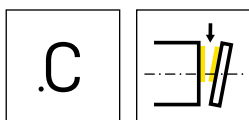

R = version à droite représentée
R = versione destra come in figura

L = version à gauche
L = versione sinistra a specchio

▲ en stock
a stock

Nuance
Leghe
Δ 4 semaines
4 settimane

N° de commande Codice prodotto	w	r	α	HIS		TC92	TF45	TI25	TN35
RS229.0530.C1	3	0,15	5°	229020 • 229030		Δ	Δ	▲	▲
RS229.0830.C1	3	0,15	8°	229020 • 229030		Δ	▲	▲	▲
RS229.0540.C1	4	0,15	5°	229030 • 229040		Δ	Δ	Δ	Δ
RS229.0840.C1	4	0,15	8°	229030 • 229040			Δ	Δ	▲
LS229.0530.C1	3	0,15	5°	229020 • 229030		Δ	Δ	▲	▲
LS229.0830.C1	3	0,15	8°	229020 • 229030		Δ	▲	Δ	▲
LS229.0540.C1	4	0,15	5°	229030 • 229040		Δ	Δ		Δ
LS229.0840.C1	4	0,15	8°	229030 • 229040		Δ	Δ	Δ	Δ
S229.0030.C1	3	0,15	0°	229020 • 229030		Δ	Δ	▲	▲
						P	●	●	●
						M	-	●	●
						K	-	●	●
						N	-	●	●
						S	-	●	●
						H	-	-	-



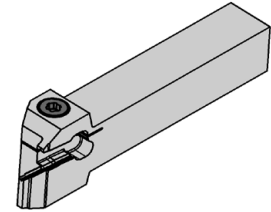
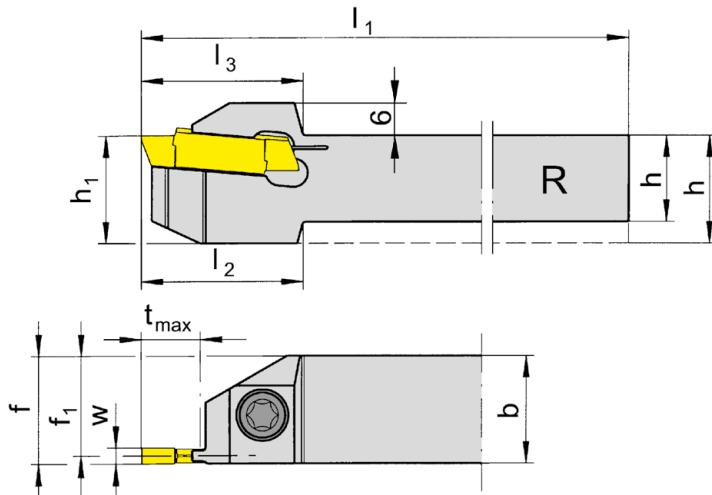
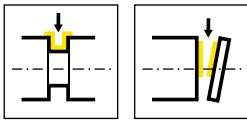

R = version à droite représentée
R = versione destra come in figura

L = version à gauche
L = versione sinistra a specchio

N° de commande Codice prodotto	h	b	l ₁	l ₂	l ₃	h ₁	f	f ₁	t _{max}	HWS
RH259.1616.03	16	16	135	30	30	20	f ₁ +w/2	14,55	11	229030
RH259.2020.03	20	20	135	-	30	20	f ₁ +w/2	18,55	11	229030
RH259.2525.03	25	25	135	-	30	25	f ₁ +w/2	23,55	11	229030
RH259.1616.13	16	16	135	33	33	20	f ₁ +w/2	14,55	18	229030
RH259.2020.13	20	20	135	-	33	20	f ₁ +w/2	18,55	18	229030
RH259.2525.13	25	25	135	-	33	25	f ₁ +w/2	23,55	18	229030
LH259.1616.03	16	16	135	30	30	20	f ₁ +w/2	14,55	11	229030
LH259.2020.03	20	20	135	-	30	20	f ₁ +w/2	18,55	11	229030
LH259.2525.03	25	25	135	-	30	25	f ₁ +w/2	23,55	11	229030
LH259.1616.13	16	16	135	33	33	20	f ₁ +w/2	14,55	18	229030
LH259.2020.13	20	20	135	-	33	20	f ₁ +w/2	18,55	18	229030
LH259.2525.13	25	25	135	-	33	25	f ₁ +w/2	23,55	18	229030

w voir plaquettes amovibles
w vd. inserti

Pièces Détachées

Ricambi

Porte outils Portainsero	Vis de serrage Vite di serraggio	Tournevis TORX PLUS® Cacciavite TORX PLUS®
R/LH259...	6.23T25P	T25PQ

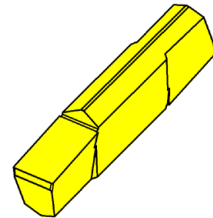
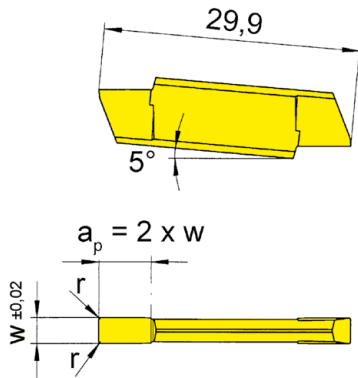
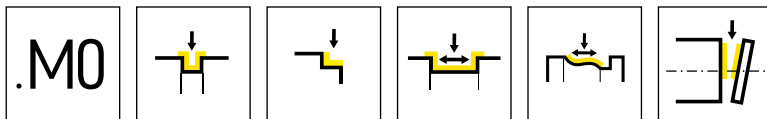

La profondeur de passe en chariotage a_p
Tornitura longitudinale fino a a_p

2 x w pour usinage des laitons (Ms58)
2 x w su ottone (Ms58)

▲ en stock
a stock

Nuance
Leghe
Δ 4 semaines
4 settimane

N° de commande Codice prodotto	w	r	HIS	MG12
259.0300.M1	3	0,15	229030	▲
259.0300.M2	3	0,2	229030	▲
259.0400.M1	4	0,15	229030	▲
259.0400.M2	4	0,2	229030	▲

P	o
M	-
K	-
N	-
S	-
H	-

