

**312**



**T**

**Porte outils et plaquettes**

Largueur de gorge 1,5 - 5 mm

**Portainserito e inserti**

Larghezza della gola 1,5 - 5 mm

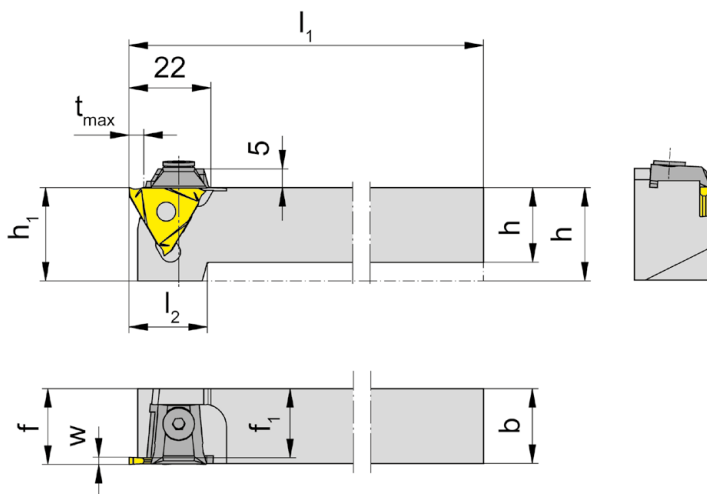
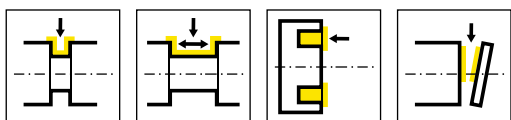

R = version à droite représentée  
R = versione destra come in figura

L = version à gauche  
L = versione sinistra a specchio

N° de commande Codice prodotto	h	b	l <sub>1</sub>	l <sub>2</sub>	h <sub>1</sub>	f <sub>1</sub>	f	t <sub>max</sub>	HWS
R360.1212.02	12	12	100	24	25	9,5	f <sub>1</sub> +w-a <sub>1</sub>	6	31202N • 31202R • 31202L
R360.1616.02	16	16	125	22	25	13,5	f <sub>1</sub> +w-a <sub>1</sub>	6	31202N • 31202R • 31202L
R360.2020.02	20	20	125	21	25	17,5	f <sub>1</sub> +w-a <sub>1</sub>	6	31202N • 31202R • 31202L
R360.2525.02	25	25	150	-	25	22,5	f <sub>1</sub> +w-a <sub>1</sub>	6	31202N • 31202R • 31202L
R360.3232.02	32	32	170	-	32	29,5	f <sub>1</sub> +w-a <sub>1</sub>	6	31202N • 31202R • 31202L
R360.1212.03	12	12	100	24	25	8,5	f <sub>1</sub> +w-a <sub>1</sub>	6	31203N • 31203R • 31203L
R360.1616.03	16	16	125	22	25	12,5	f <sub>1</sub> +w-a <sub>1</sub>	6	31203N • 31203R • 31203L
R360.2020.03	20	20	125	21	25	16,5	f <sub>1</sub> +w-a <sub>1</sub>	6	31203N • 31203R • 31203L
R360.2525.03	25	25	150	-	25	21,5	f <sub>1</sub> +w-a <sub>1</sub>	6	31203N • 31203R • 31203L
R360.3232.03	32	32	170	-	32	28,5	f <sub>1</sub> +w-a <sub>1</sub>	6	31203N • 31203R • 31203L
L360.1212.02	12	12	100	24	25	9,5	f <sub>1</sub> +w-a <sub>1</sub>	6	31202N • 31202R • 31202L
L360.1616.02	16	16	125	22	25	13,5	f <sub>1</sub> +w-a <sub>1</sub>	6	31202N • 31202R • 31202L
L360.2020.02	20	20	125	21	25	17,5	f <sub>1</sub> +w-a <sub>1</sub>	6	31202N • 31202R • 31202L
L360.2525.02	25	25	150	-	25	22,5	f <sub>1</sub> +w-a <sub>1</sub>	6	31202N • 31202R • 31202L
L360.3232.02	32	32	170	-	32	29,5	f <sub>1</sub> +w-a <sub>1</sub>	6	31202N • 31202R • 31202L
L360.1212.03	12	12	100	24	25	8,5	f <sub>1</sub> +w-a <sub>1</sub>	6	31203N • 31203R • 31203L
L360.1616.03	16	16	125	22	25	12,5	f <sub>1</sub> +w-a <sub>1</sub>	6	31203N • 31203R • 31203L
L360.2020.03	20	20	125	21	25	16,5	f <sub>1</sub> +w-a <sub>1</sub>	6	31203N • 31203R • 31203L
L360.2525.03	25	25	150	-	25	21,5	f <sub>1</sub> +w-a <sub>1</sub>	6	31203N • 31203R • 31203L
L360.3232.03	32	32	170	-	32	28,5	f <sub>1</sub> +w-a <sub>1</sub>	6	31203N • 31203R • 31203L

w, a1 voir plaquettes amovibles  
w, a1 vd. inserti

### Pièces Détachées

Ricambi

Porte outils Portainsero	Bride Staffa
R/L360.1...	11.3
R/L360...	16.4

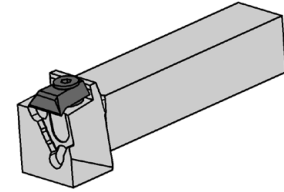
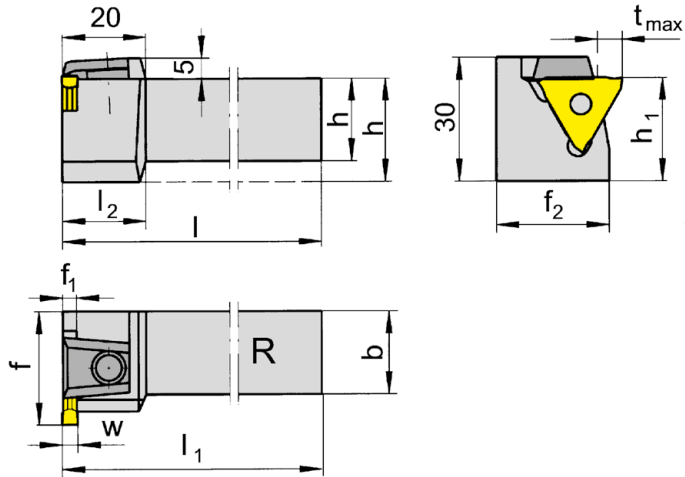
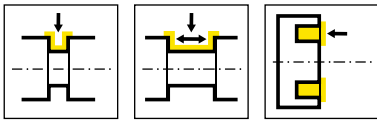

R = version à droite représentée  
R = versione destra come in figura

L = version à gauche  
L = versione sinistra a specchio

N° de commande Codice prodotto	h	b	l	l <sub>1</sub>	l <sub>2</sub>	h <sub>1</sub>	f	t <sub>max</sub>	f <sub>1</sub>	f <sub>2</sub>	HWS
R369.2020.02	20	20	125	l-f <sub>1</sub> +w-a <sub>1</sub>	20	25	27	6	2,5	23,5	31202N • 31202R • 31202L
R369.2525.02	25	25	150	l-f <sub>1</sub> +w-a <sub>1</sub>	-	25	32	6	2,5	28,5	31202N • 31202R • 31202L
R369.2020.03	20	20	125	l-f <sub>1</sub> +w-a <sub>1</sub>	20	25	27	6	3,5	23,5	31203N • 31203R • 31203L
R369.2525.03	25	25	150	l-f <sub>1</sub> +w-a <sub>1</sub>	-	25	32	6	3,5	28,5	31203N • 31203R • 31203L
L369.2020.02	20	20	125	l-f <sub>1</sub> +w-a <sub>1</sub>	20	25	27	6	2,5	23,5	31202N • 31202R • 31202L
L369.2525.02	25	25	150	l-f <sub>1</sub> +w-a <sub>1</sub>	-	25	32	6	2,5	28,5	31202N • 31202R • 31202L
L369.2020.03	20	20	125	l-f <sub>1</sub> +w-a <sub>1</sub>	20	25	27	6	3,5	23,5	31203N • 31203R • 31203L
L369.2525.03	25	25	150	l-f <sub>1</sub> +w-a <sub>1</sub>	-	25	32	6	3,5	28,5	31203N • 31203R • 31203L

w, a1 voir plaquettes amovibles  
w, a1 vd. inserti

### Pièces Détachées

Ricambi

Porte outils Portainsero	Bride Staffa
R/L369...	16.4



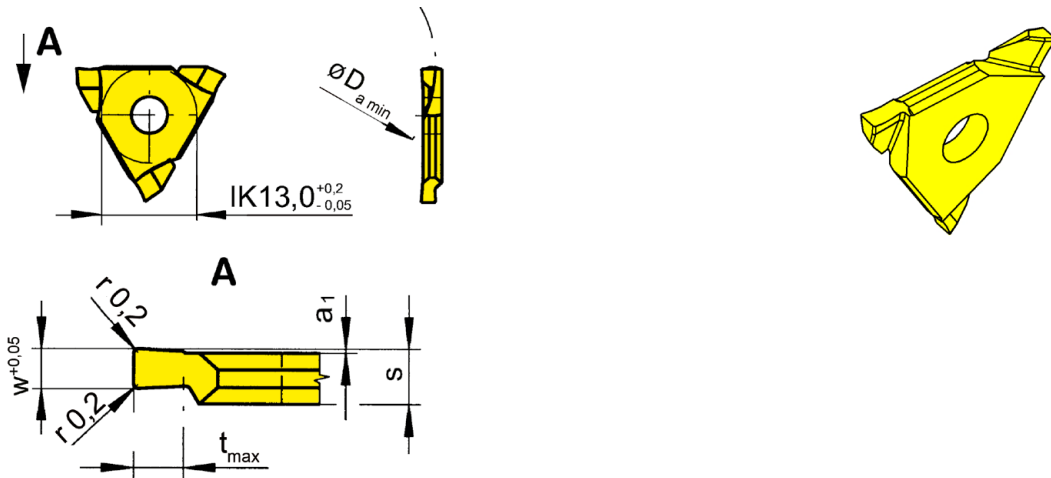
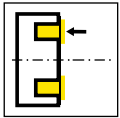

R = version à droite représentée  
R = versione destra come in figura

L = version à gauche  
L = versione sinistra a specchio

▲ en stock  
a stock

Nuance  
Leghe  
Δ 4 semaines  
4 settimane

N° de commande Codice prodotto	w	t <sub>max</sub>	a <sub>1</sub>	s	D <sub>a min</sub>	HIS	Nuance Leghe		
							MG12	EG55	TN35
R312.2015.02	1,5	2	0,2	2,7	20	31202N • 31202R • 31202R		▲	▲
R312.3020.02	2	3	0,2	2,7	30	31202N • 31202R • 31202R		▲	▲
R312.3030.02	3	3	0,2	3,7	30	31203N • 31203R • 31203R		▲	▲
R312.3050.02	5	3,5	0,2	5,3	30	31204N • 31204R • 31204R		Δ	
L312.2015.02	1,5	2	0,2	2,7	20	31202N • 31202R • 31202L		▲	▲
L312.3020.02	2	3	0,2	2,7	30	31202N • 31202R • 31202L	Δ	▲	▲
L312.3030.02	3	3	0,2	3,7	30	31203N • 31203R • 31203L		▲	▲
L312.3050.02	5	3,5	0,2	5,3	30	31204N • 31204R • 31204L		Δ	
							P	o	•
							M	-	o
							K	-	o
							N	-	-
							S	-	-
							H	-	-

T

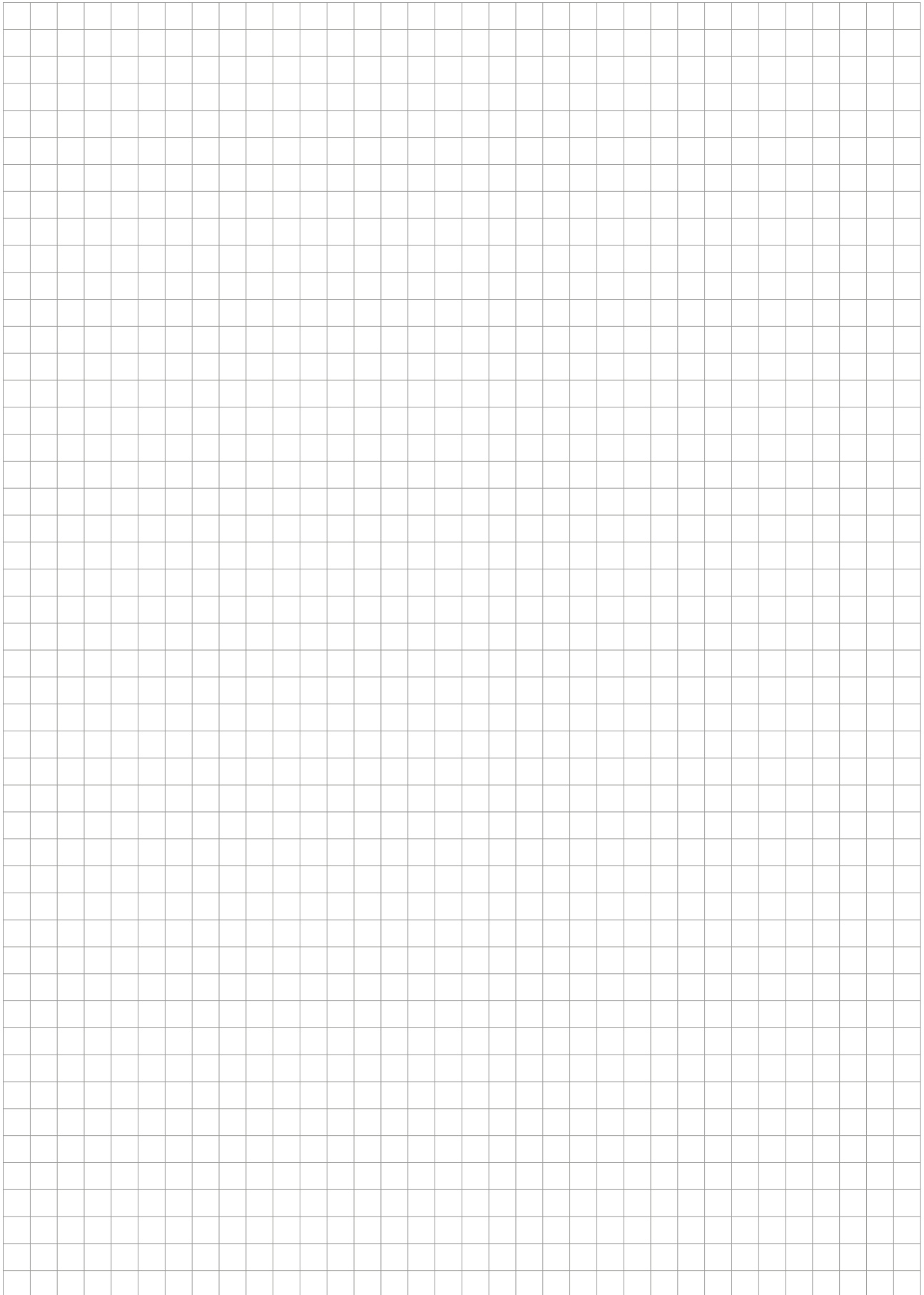

Porte outils  
Portainserito  
356/357

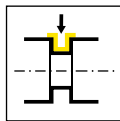

Page/Pag.  
598-599

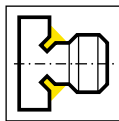

Page/Pag.  
600

Plaquette amovible  
Inserto  
A315

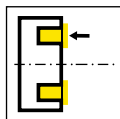

Page/Pag.  
601-603

Informations techniques  
Informazioni tecniche

Page/Pag.  
604