

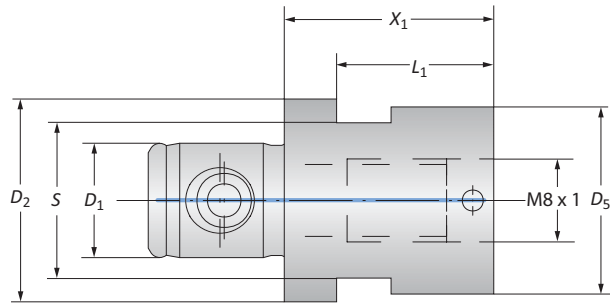

Adapters



Adapters

MVS Connection	Boring Connection	Adapter				Weight	Service Key	Part No.
		$D_2 D_1$	X_1	L_1	S			
 19.5 - 11	M8 x 1	20.00	15.00	15/P	18.00	0.05 (kg)	15 S / P	219168
23 - 11	M8 x 1	20.00	-	19/P	23.00	0.07 (kg)	19 S / P	219169

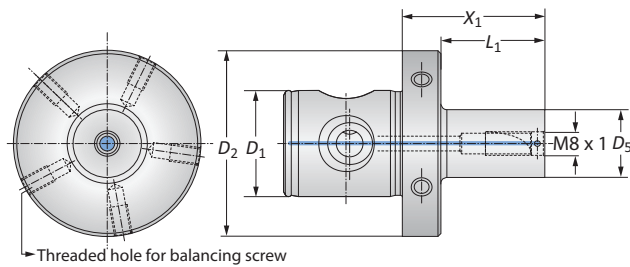

Balanced Adapters

MVS Connection	Boring Connection	Adapter			Weight	Balancing Screw	Part No.
		$D_2 D_1$	X_1	L_1			
 50 - 28	M8 x 1	32.00	19.00	15.00	0.35 (kg)	M6 x 1 x 10	219185
50 - 28	M8 x 1	48.00	35.00	18.00	0.40 (kg)	M6 x 1 x 10	219176
50 - 28	M8 x 1	48.00	35.00	23.00	0.45 (kg)	M6 x 1 x 10	219177

NOTE: Balance refers to a specific residual imbalance of ≤ 10 g mm/kg

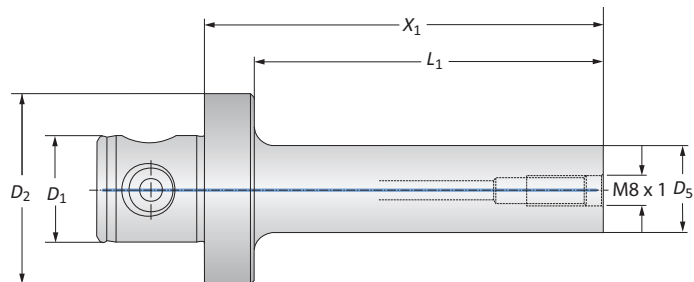

Vibration Reducing Heavy Metal Adapters

MVS Connection	Boring Connection	Adapter			Weight	Part No.
		$D_2 D_1$	X_1	L_1		
 50 - 28	M8 x 1	68.00	55.00	15.00	0.80 (kg)	248147
50 - 28	M8 x 1	84.00	71.00	19.00	1.00 (kg)	248148
50 - 28	M8 x 1	104.00	91.00	23.00	1.30 (kg)	248149

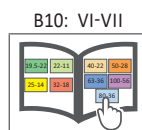
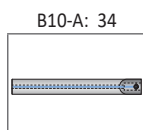
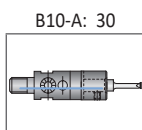
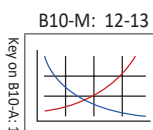

 = Metric (mm)