

537 Accessories | 3E<sup>TECH</sup> Accessories | Clamping Pieces

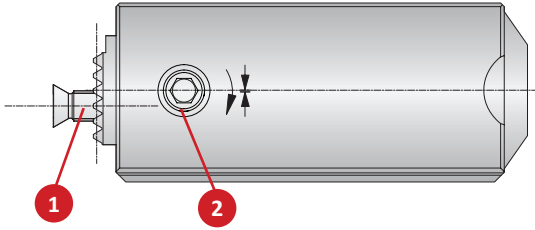

537 Analogue Cassette

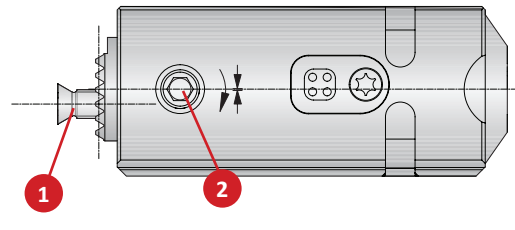

537 3E<sup>TECH</sup> Cassette

537 Accessories

Cassette Part No.	1 Countersunk Screw		2 Clamping Screw	
	Part No.	Service Key	Part No.	Service Key
537051	215462	T20 / H	115249	s4 / F
537052	215462	T20 / H	315789	s4 / F

3E<sup>TECH</sup> Accessories

1
Charging Unit
Part No.
536016



NOTE: Charging unit sold separately from 3E<sup>TECH</sup>

NOTE: 3E<sup>TECH</sup> adjustment accuracy of 0.0001" or 0.001 mm on diameter

3E<sup>TECH</sup> Accessories (Old Display)

1	2
Sealing Ring	Battery CR2032
Part No.	Part No.
215483	515491

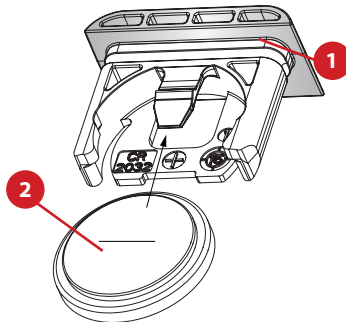

NOTE: Not required for 3E<sup>TECH</sup> (New Display)

537 Clamping Pieces

Slide Type	Complete Part No.	Service Key		Replacement Components		
				1 Cap Screw	2 Clamping Nut	3 Disk Spring
Serrated Tool Bodies	137026	115578	s6 / B	215101	140118	337105
Basic and Eco Slides	137027			215102	215105	337105
Flex Slides	137019			415900	215105	337105

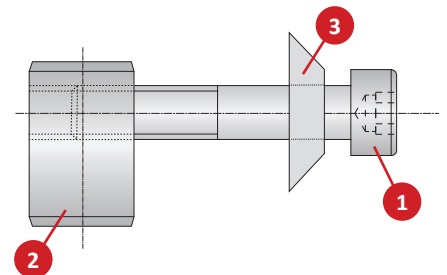

NOTE: Clamping pieces sold separately

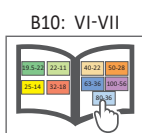
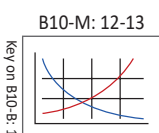

 = Metric (mm)  
Inserts sold separately