

UPA 4 Boring Heads and Accessories

Diameter Range: 0.000" - 15.748" (0.00 mm - 400.00 mm)

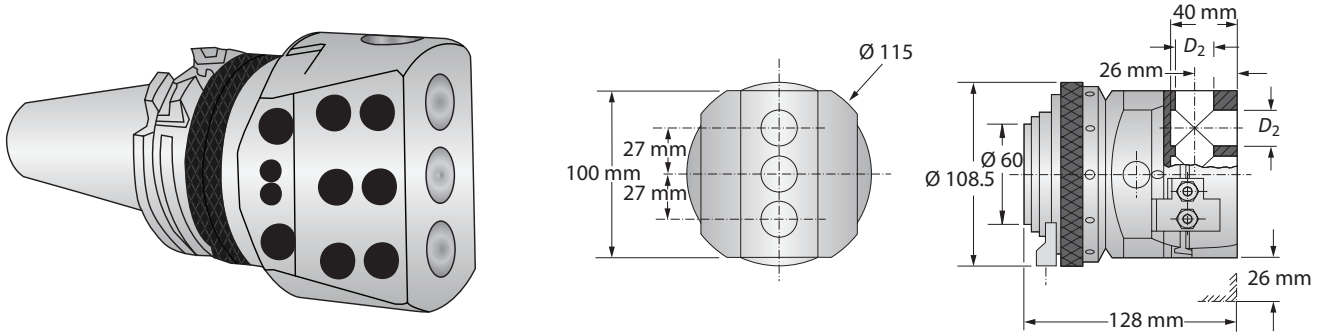

UPA 4 Boring Heads

		Boring Head		
Boring Range	D_2	Weight	Part No.	
0.00 - 400.00	22.00	6.50 (kg)	007020	

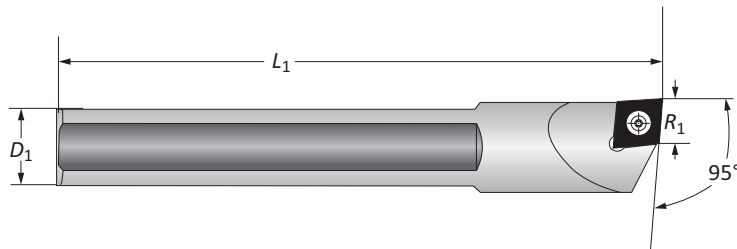

UPA 4 Boring Bars

		Boring Bar					
D_1	L_1	R_1	Weight	Cutting Direction	Insert Form	Part No.	
22.00	100.00	13.50	0.10 (kg)	R	103	081092	
22.00	100.00	13.50	0.10 (kg)	L	103	218089	

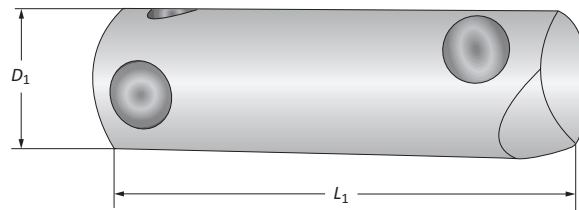

UPA 4 Boring Bars

		Boring Bar			
D_1	L_1	Boring Depth	Designation	Part No.	
22.00	85.00	45.00	B 408	073006	
22.00	125.00	85.00	B 412	073007	
22.00	165.00	125.00	B 416	073008	

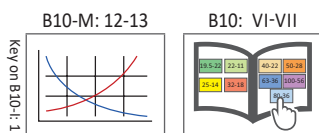

UPA 4 Accessories

Reducing Sleeves | Boring Bar Holders

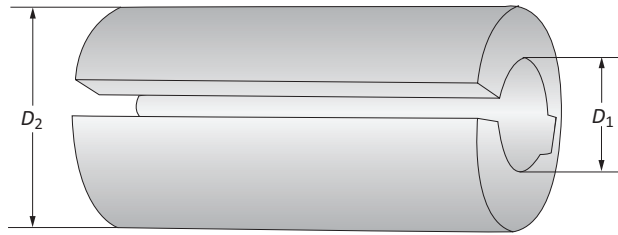

UPA 4 Reducing Sleeves

Reducing Sleeve			
D_2	D_1	Weight	Part No.
22.00	8.00	0.10 (kg)	071107
22.00	10.00	0.10 (kg)	071108
22.00	12.00	0.10 (kg)	071109
22.00	14.00	0.08 (kg)	071110
22.00	18.00	0.08 (kg)	071111

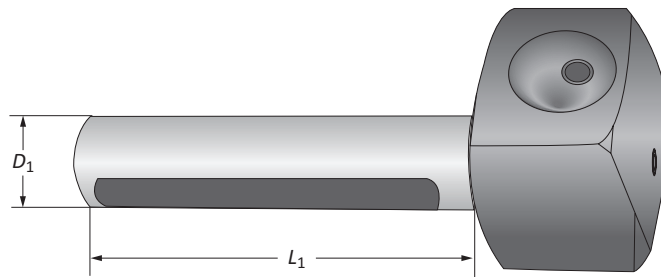

UPA 4 Boring Bar Holders

Boring Bar Holder				
D_1	L_1	Designation	Working Diameter Range	Part No.
22.00	98.00	BH 410	115.00 - 240.00	075003
22.00	180.00	BH 418	220.00 - 400.00	075004

UPA 4 Square Turning Bit

Square Turning Bit			
S	L_1	Weight	Part No.
6.00	40.00	11 (g)	089001

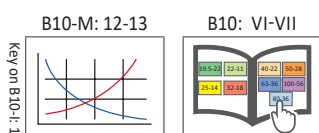
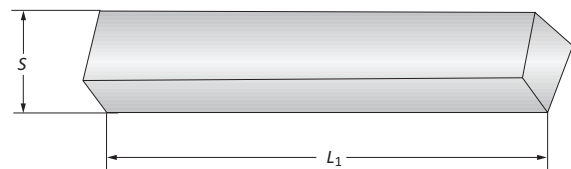

m = Metric (mm)

UPA 5-S 6 Boring Heads and Accessories

Diameter Range: 0.00 mm - 620.00 mm

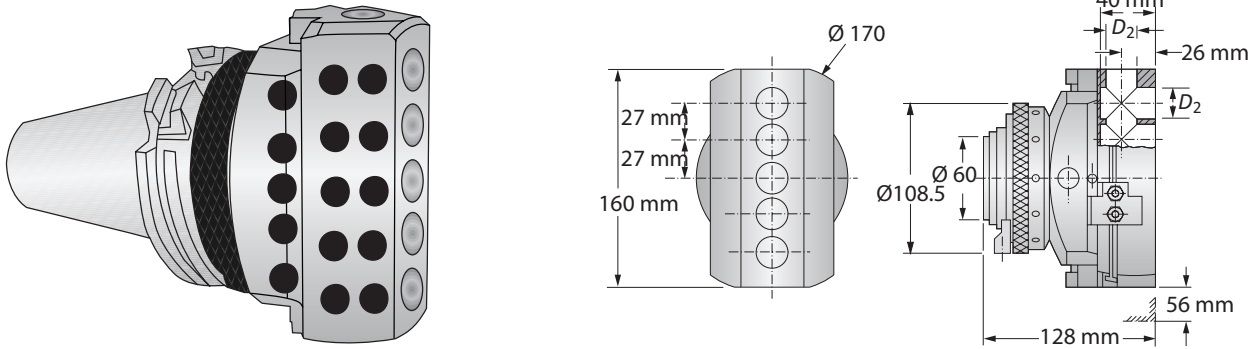

UPA 5-S 6 Boring Heads

		Boring Head		
Boring Range	D_2	Weight	Part No.	
0.00 - 620.00	22.00	7.90 (kg)	013020	

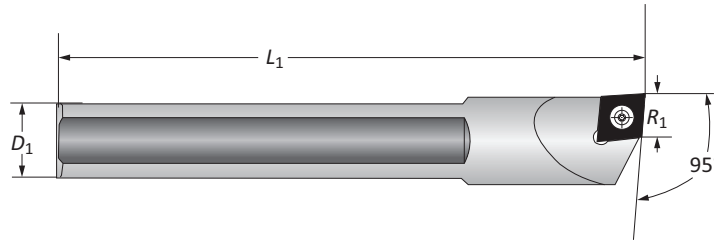

UPA 5-S 6 Boring Bars

		Boring Bar					
D_1	L_1	R_1	Weight	Cutting Direction	Insert Form	Part No.	
22.00	100.00	13.50	0.10 (kg)	R	103	081092	
22.00	100.00	13.50	0.10 (kg)	L	103	218089	

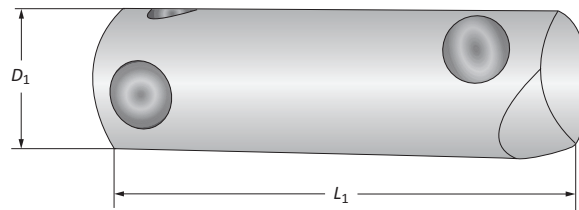

UPA 5-S 6 Boring Bars

		Boring Bar			
D_1	L_1	Boring Depth	Designation	Part No.	
22.00	85.00	45.00	B 408	073006	
22.00	125.00	85.00	B 412	073007	
22.00	165.00	125.00	B 416	073008	

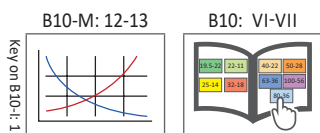

Ⓜ = Metric (mm)

UPA 5-S 6 Accessories

Reducing Sleeves | Boring Bar Holders

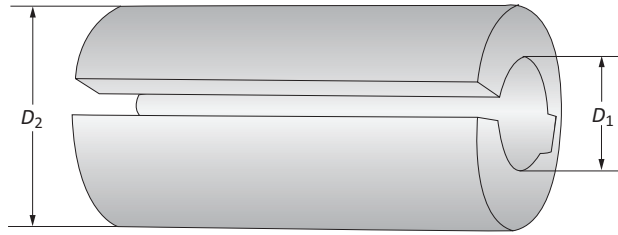

UPA 5-S 6 Reducing Sleeves

Reducing Sleeve				
	D_2	D_1	Weight	Part No.
m	22.00	8.00	0.10 (kg)	071107
	22.00	10.00	0.10 (kg)	071108
	22.00	12.00	0.10 (kg)	071109
	22.00	14.00	0.08 (kg)	071110
	22.00	18.00	0.08 (kg)	071111

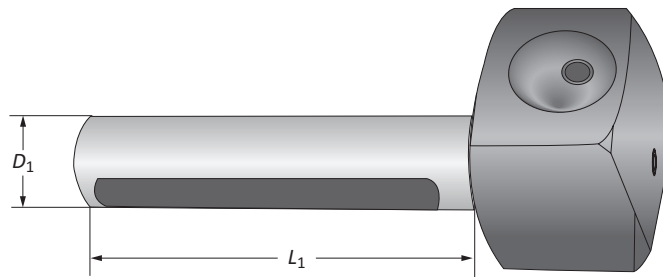

UPA 5-S 6 Boring Bar Holders

Boring Bar Holder					
	D_1	L_1	Designation	Working Diameter Range	Part No.
m	22.00	228.00	BH 513	120.00 - 400.00	075003
	22.00	230.00	BH 523	270.00 - 620.00	075004

UPA 5-S 6 Square Turning Bit

Square Turning Bit				
	S	L_1	Weight	Part No.
m	6.00	40.00	11 (g)	089001

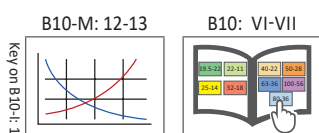
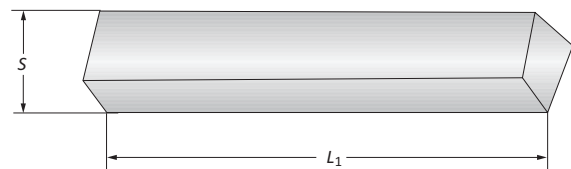

m = Metric (mm)

UPA 4 and 5-S 6 Master Shanks

CAT 40/50 | Morse Taper | NMTB 40/50

CAT 40/50 Shanks

Shank				
	Style	D_{10}	Weight	Part No.
m	CAT 40	M16 x 2	1.45 (kg)	130005T016960
	CAT 50	M24 x 3	3.20 (kg)	130005T016962

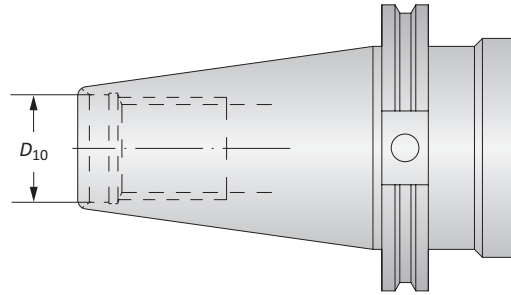

Morse Taper Shanks

Shank			
	Style	Weight	Part No.
m	MT 4	0.86 (kg)	130005T003590
	MT 5	1.65 (kg)	130005T003920

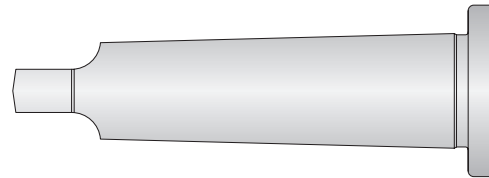

NMTB 40/50 Shanks

Shank				
	Style	D_{10}	Weight	Part No.
m	NMTB40	5/8 - 11	1.30 (kg)	130005T004498
	NMTB50	1 - 8	2.90 (kg)	130005T004480

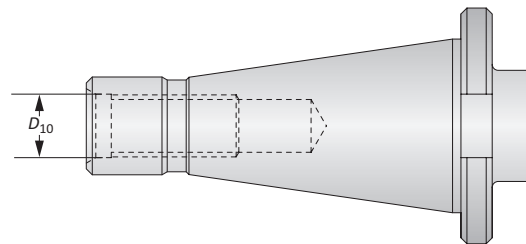

Differential Screw

	Thread	Weight	Part No.
m	M20 x 2.5	0.07 (kg)	KW9209

