

## Accessories for Collet Chucks

Diameter Range: 0.50 mm - 10.00 mm

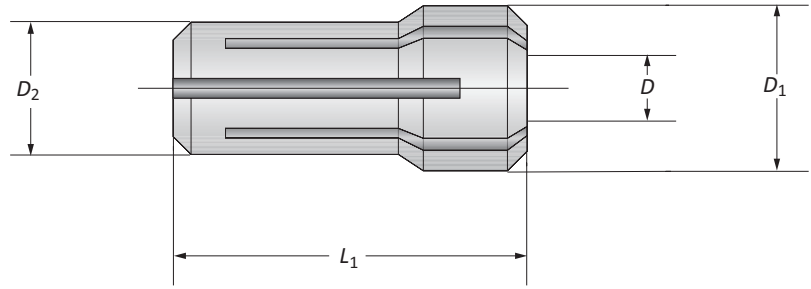

### Collet Sets for Erickson System

Metric	Nominal Size	Standard-No.	Set				Part No.
			$D_1$	$D_2$	$L_1$	$D$	
	6	416 E	9.50	7.62	25.50	0.50 - 6.00	<b>071016</b>
	10	417 E	13.50	11.43	30.40	0.50 - 10.00	<b>071017</b>

### Collets for Erickson System

Metric	Collet	Diameter Range	Part No.
	Nominal Size	$D$	
m	6	0.50 - 1.00	<b>071355</b>
	6	1.00 - 1.50	<b>071356</b>
	6	1.50 - 2.00	<b>071357</b>
	6	2.00 - 2.50	<b>071358</b>
	6	2.50 - 3.00	<b>071359</b>
	6	3.00 - 3.50	<b>071360</b>
	6	3.50 - 4.00	<b>071361</b>
	6	4.00 - 4.50	<b>071362</b>
	6	4.50 - 5.00	<b>071363</b>
	6	5.00 - 5.50	<b>071364</b>
	6	5.50 - 6.00	<b>071365</b>
	10	0.50 - 1.00	<b>071368</b>
	10	1.00 - 1.50	<b>071369</b>
	10	1.50 - 2.00	<b>071370</b>
	10	2.00 - 2.50	<b>071371</b>
	10	2.50 - 3.00	<b>071372</b>
	10	3.00 - 3.50	<b>071373</b>
	10	3.50 - 4.00	<b>071374</b>
	10	4.00 - 4.50	<b>071375</b>
	10	4.50 - 5.00	<b>071376</b>
10	5.00 - 5.50	<b>071377</b>	
10	5.50 - 6.00	<b>071378</b>	
10	6.00 - 6.50	<b>071379</b>	
10	6.50 - 7.00	<b>071380</b>	
10	7.00 - 7.50	<b>071381</b>	
10	7.50 - 8.00	<b>071382</b>	
10	8.00 - 8.50	<b>071383</b>	
10	8.50 - 9.00	<b>071384</b>	
10	9.00 - 9.50	<b>071385</b>	
10	9.50 - 10.00	<b>071681</b>	

B10-M: 12-13

B10: VI-VII

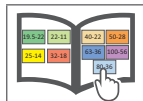
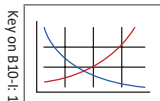

**m** = Metric (mm)

## Accessories for Collet Chucks

ISO 10897-A (DIN 6388-A)

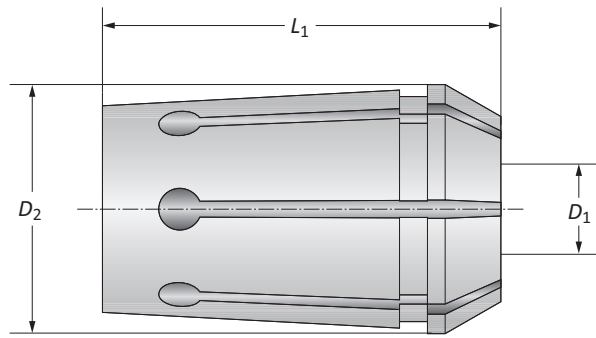

### Collet Sets

	Nominal Size	Standard-No.	Set			Part No.
			$D_2$	$L_1$	$D_1$	
m	A 16	410 E	22.65	40.00	2.00 - 16.00	071003
	A 25	444 E	32.90	52.00	2.00 - 25.00	071004
	A 32	450 E	41.30	60.00	4.00 - 32.00	071019

### Collets

	Nominal Size	Diameter	
		$D_1$	Part No.
m	A 16	2.00	071140
	A 16	2.50	071141
	A 16	3.00	071142
	A 16	3.50	071143
	A 16	4.00	071144
	A 16	4.50	071145
	A 16	5.00	071146
	A 16	5.50	071147
	A 16	6.00	071148
	A 16	6.50	071149
	A 16	7.00	071150
	A 16	7.50	071151
	A 16	8.00	071152
	A 16	8.50	071153
	A 16	9.00	071154
	A 16	9.50	071155
	A 16	10.00	071156
	A 16	10.50	071157
	A 16	11.00	071158
	A 16	11.50	071159
A 16	12.00	071160	
A 16	12.50	071161	
A 16	13.00	071162	
A 16	13.50	071163	
A 16	14.00	071164	
A 16	14.50	071165	
A 16	15.00	071166	
A 16	15.50	071167	
A 16	16.00	071168	

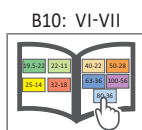
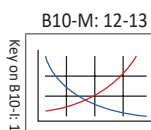

m = Metric (mm)

## Accessories for Collet Chucks

ISO 10897-A (DIN 6388-A)

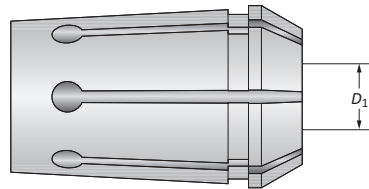

### Collets

	Nominal Size	Diameter	
		$D_1$	Part No.
	A 25	2.00	071169
	A 25	3.00	071170
	A 25	4.00	071171
	A 25	5.00	071172
	A 25	6.00	071173
	A 25	7.00	071174
	A 25	8.00	071175
	A 25	9.00	071176
	A 25	10.00	071177
	A 25	11.00	071178
	A 25	12.00	071179
	A 25	13.00	071180
	A 25	14.00	071181
	A 25	15.00	071182
	A 25	16.00	071183
	A 25	17.00	071184
	A 25	18.00	071185
	A 25	19.00	071186
	A 25	20.00	071187
	A 25	21.00	071188
	A 25	22.00	071189
	A 25	23.00	071190
	A 25	24.00	071191
	A 25	25.00	071192
	A 32	4.00	071612
	A 32	5.00	071419
III	A 32	6.00	071420
	A 32	7.00	071613
	A 32	8.00	071421
	A 32	9.00	071614
	A 32	10.00	071422
	A 32	11.00	071666
	A 32	12.00	071423
	A 32	13.00	071667
	A 32	14.00	071668
	A 32	15.00	071669
	A 32	16.00	071424
	A 32	17.00	071670
	A 32	18.00	071665
	A 32	19.00	071671
	A 32	20.00	071416
	A 32	21.00	071672
	A 32	22.00	071673
	A 32	23.00	071674
	A 32	24.00	071675
	A 32	25.00	071417
	A 32	26.00	071676
	A 32	27.00	071677
	A 32	28.00	071678
	A 32	29.00	071679
	A 32	30.00	071633
	A 32	31.00	071680
	A 32	32.00	071418

## Accessories for Collet Chucks

ISO 10897-B (DIN 6388-B)

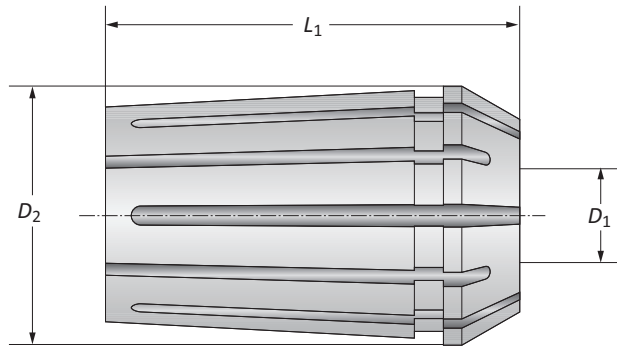

### Collet Sets

	Nominal Size	Standard-No.	Set			Part No.
			$D_2$	$L_1$	$D_1$	
<b>m</b>	B 16	415 E	22.65	40.00	1.50 - 16.00	<b>071005</b>
	B 25	462 E	32.90	52.00	3.50 - 25.00	<b>071006</b>
	B 32	467 E	41.30	60.00	5.50 - 32.00	<b>071022</b>

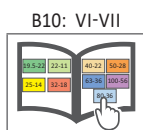
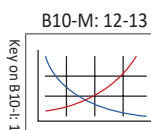

**m** = Metric (mm)

## Accessories for Collet Chucks

ISO 10897-B (DIN 6388-B)

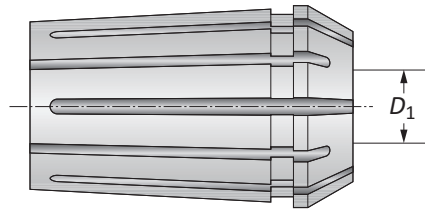

### Collets

Nominal Size	Diameter $D_1$	Part No.
B 25	3.50 - 4.00	071627
B 25	4.00 - 4.50	071628
B 25	4.50 - 5.00	071218
B 25	5.00 - 5.50	071219
B 25	5.50 - 6.00	071220
B 25	6.00 - 6.50	071221
B 25	6.50 - 7.00	071222
B 25	7.00 - 7.50	071223
B 25	7.50 - 8.00	071224
B 25	8.00 - 8.50	071225
B 25	8.50 - 9.00	071226
B 25	9.00 - 9.50	071227
B 25	9.50 - 10.00	071228
B 25	10.00 - 10.50	071229
B 25	10.50 - 11.00	071230
B 25	11.00 - 11.50	071231
B 25	11.50 - 12.00	071232
B 25	12.00 - 12.50	071233
B 25	12.50 - 13.00	071234
B 25	13.00 - 13.50	071235
B 25	13.50 - 14.00	071236
B 25	14.00 - 14.50	071237
B 25	14.50 - 15.00	071238
B 25	15.00 - 15.50	071239
B 25	15.50 - 16.00	071240
B 25	16.00 - 16.50	071241
B 25	16.50 - 17.00	071242
B 25	17.00 - 17.50	071243
B 25	17.50 - 18.00	071244
B 25	18.00 - 18.50	071245
B 25	18.50 - 19.00	071246
B 25	19.00 - 19.50	071247
B 25	19.50 - 20.00	071248
B 25	20.00 - 20.50	071249
B 25	20.50 - 21.00	071250
B 25	21.00 - 21.50	071251
B 25	21.50 - 22.00	071252
B 25	22.00 - 22.50	071253
B 25	22.50 - 23.00	071254
B 25	23.00 - 23.50	071255
B 25	23.50 - 24.00	071256
B 25	24.00 - 24.50	071257
B 25	24.50 - 25.00	071258

mm

B10-M: 12-13

B10: VI-VII

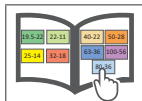
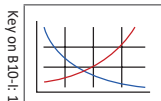

mm = Metric (mm)

Accessories for Collet Chucks

ISO 10897-B (DIN 6388-B)

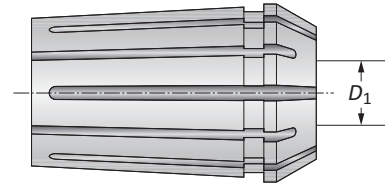

Collets

Nominal Size	Diameter	Part No.
	$D_1$	
B 32	5.50 - 6.00	071686
B 32	6.00 - 6.50	071687
B 32	6.50 - 7.00	071688
B 32	7.00 - 7.50	071689
B 32	7.50 - 8.00	071690
B 32	8.00 - 8.50	071691
B 32	8.50 - 9.00	071692
B 32	9.00 - 9.50	071693
B 32	9.50 - 10.00	071542
B 32	10.00 - 10.50	071543
B 32	10.50 - 11.00	071544
B 32	11.00 - 11.50	071545
B 32	11.50 - 12.00	071546
B 32	12.00 - 12.50	071547
B 32	12.50 - 13.00	071548
B 32	13.00 - 13.50	071549
B 32	13.50 - 14.00	071550
B 32	14.00 - 14.50	071551
B 32	14.50 - 15.00	071552
B 32	15.00 - 15.50	071553
B 32	15.50 - 16.00	071554
B 32	16.00 - 16.50	071555
B 32	16.50 - 17.00	071556
B 32	17.00 - 17.50	071557
B 32	17.50 - 18.00	071558
B 32	18.00 - 18.50	071559
B 32	18.50 - 19.00	071560
B 32	19.00 - 19.50	071561
B 32	19.50 - 20.00	071562
B 32	20.00 - 20.50	071563
B 32	20.50 - 21.00	071564
B 32	21.00 - 21.50	071565
B 32	21.50 - 22.00	071566
B 32	22.00 - 22.50	071567
B 32	22.50 - 23.00	071568
B 32	23.00 - 23.50	071569
B 32	23.50 - 24.00	071570
B 32	24.00 - 24.50	071571
B 32	24.50 - 25.00	071572
B 32	25.00 - 25.50	071573
B 32	25.50 - 26.00	071574
B 32	26.00 - 26.50	071575
B 32	26.50 - 27.00	071576
B 32	27.00 - 27.50	071577
B 32	27.50 - 28.00	071578
B 32	28.00 - 28.50	071579
B 32	28.50 - 29.00	071580
B 32	29.00 - 29.50	071581
B 32	29.50 - 30.00	071582
B 32	30.00 - 30.50	071583
B 32	30.50 - 31.00	071584
B 32	31.00 - 31.50	071585
B 32	31.50 - 32.00	071586

m

## Accessories for Collet Chucks

ISO 10897-A (DIN 6388-A)

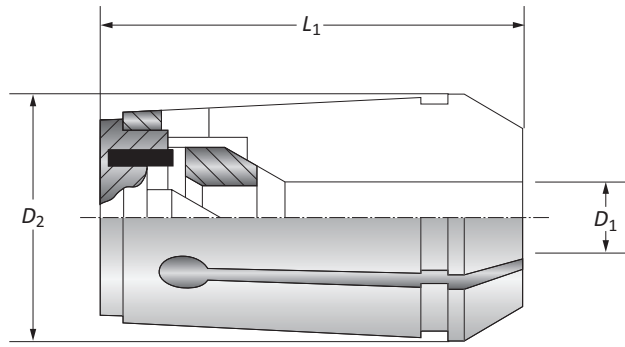

### Collet Sets for Clarkson System

	Nominal Size	Standard-No.	Diameter		Part No.
			$D_1$	$D_2$	
m	A 16	421 E	6.00 - 12.00	22.65	071013
	A 25	459 E	6.00 - 25.00	32.90	071014
	A 32	460 E	6.00 - 32.00	41.30	071020

**NOTE:** Recommended to use clamping nuts with ball-bearings to lock collets

### Collets for Clarkson System

	Nominal Size	Diameter	
		$D_1$	Part No.
m	A 16	6.00	071304
	A 16	8.00	071305
	A 16	10.00	071306
	A 16	12.00	071307
	A 25	6.00	071308
	A 25	8.00	071309
	A 25	10.00	071310
	A 25	12.00	071311
	A 25	16.00	071312
	A 25	20.00	071313
	A 25	25.00	071684
	A 32	6.00	071427
	A 32	8.00	071428
	A 32	10.00	071429
	A 32	12.00	071430
	A 32	16.00	071431
A 32	20.00	071432	
A 32	25.00	071433	
A 32	32.00	071685	

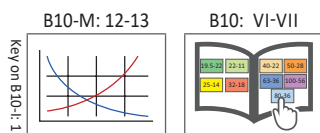

## Accessories for Collet Chucks

ISO 15488-B (DIN 6499-B)

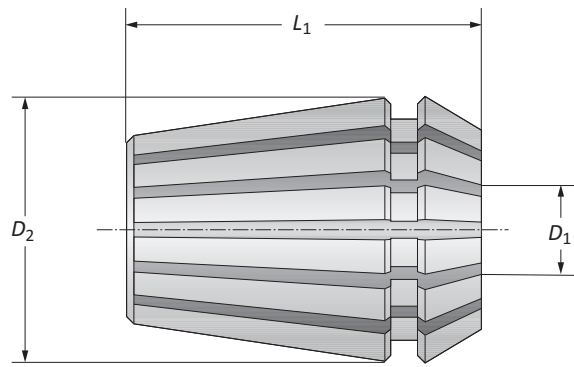

### Collet Sets

	Nominal Size	Standard-No.	Diameter		Collet Set		Part No.
			$D_1$	$D_2$	$L_1$		
m	ER 8	4004 E	1.00 - 5.00	8.50	13.50	<b>071034</b>	
	ER 11	4008 E	1.00 - 7.00	11.00	18.00	<b>071028</b>	
	ER 16	426 E	0.50 - 10.00	16.00	27.50	<b>071029</b>	
	ER 25	430 E	1.50 - 16.00	25.00	34.00	<b>071031</b>	
	ER 32	470 E	2.00 - 20.00	32.00	40.00	<b>071032</b>	
	ER 40	472 E	3.00 - 26.00	40.00	46.00	<b>071033</b>	

### Collets

	Nominal Size	Diameter		Part No.
		$D_1$		
m	ER 8	1.00		<b>071986</b>
	ER 8	1.50		<b>071987</b>
	ER 8	2.00		<b>071988</b>
	ER 8	2.50		<b>071989</b>
	ER 8	2.60 - 3.00		<b>071990</b>
	ER 8	3.10 - 3.50		<b>071991</b>
	ER 8	3.60 - 4.00		<b>071992</b>
	ER 8	4.10 - 4.50		<b>071993</b>
	ER 8	4.60 - 5.00		<b>071994</b>
	ER 11	1.00		<b>071700</b>
	ER 11	1.50		<b>071701</b>
	ER 11	2.00		<b>071702</b>
	ER 11	2.50		<b>071703</b>
	ER 11	2.60 - 3.00		<b>071704</b>
	ER 11	3.10 - 3.50		<b>071705</b>
	ER 11	3.60 - 4.00		<b>071706</b>
	ER 11	4.10 - 4.50		<b>071707</b>
	ER 11	4.60 - 5.00		<b>071708</b>
	ER 11	5.10 - 5.50		<b>071709</b>
	ER 11	5.60 - 6.00		<b>071710</b>
	ER 11	6.10 - 6.50		<b>071711</b>
	ER 11	6.60 - 7.00		<b>071712</b>

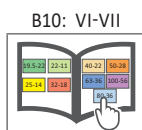
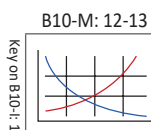

m = Metric (mm)



## Accessories for Collet Chucks

ISO 15488-B (DIN 6499-B)

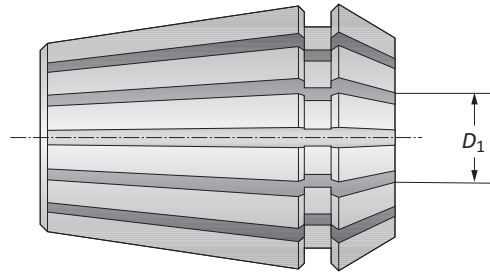

### Collets

	Nominal Size	Diameter		
			$D_1$	
	ER 16		0.50 - 1.00	071713
	ER 16		1.00 - 1.50	071714*
	ER 16		1.00 - 2.00	071715
	ER 16		2.00 - 2.50	071716*
	ER 16		2.50 - 3.00	071717
	ER 16		3.00 - 3.50	071718*
	ER 16		3.50 - 4.00	071719
	ER 16		4.00 - 4.50	271132*
<b>m</b>	ER 16		4.00 - 5.00	071720
	ER 16		5.00 - 5.50	271133*
	ER 16		5.50 - 6.00	071721
	ER 16		6.00 - 6.50	271134*
	ER 16		6.00 - 7.00	071722
	ER 16		7.00 - 7.50	271135*
	ER 16		7.5 - 8.00	071723
	ER 16		8.00 - 8.50	271136*
	ER 16		8.50 - 9.00	071724
	ER 16		9.00 - 9.50	271137*
	ER 16		9.00 - 10.00	071725

\* Items not contained in set.

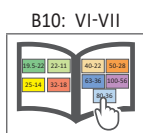
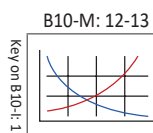







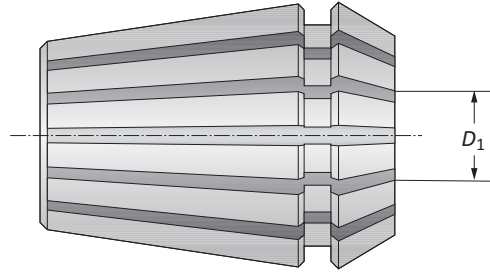













**m** = Metric (mm)

## Accessories for Collet Chucks

ISO 15488-B (DIN 6499-B)



### Collets

Nominal Size	Diameter		Part No.
	$D_1$		
ER 25	1.50 - 2.00		071743
ER 25	2.00 - 2.50		071744*
ER 25	2.50 - 3.00		071745
ER 25	3.00 - 3.50		271128*
ER 25	3.50 - 4.00		071746
ER 25	4.00 - 4.50		271129*
ER 25	4.50 - 5.00		071747
ER 25	5.00 - 5.50		271130*
ER 25	5.50 - 6.00		071748
ER 25	6.00 - 6.50		271131*
ER 25	6.50 - 7.00		071749
ER 25	7.00 - 8.00		071750
ER 25	8.00 - 9.00		071751
ER 25	9.00 - 10.00		071752
ER 25	10.00 - 11.00		071753
ER 25	11.00 - 12.00		071754
ER 25	12.00 - 13.00		071755
ER 25	13.00 - 14.00		071756
ER 25	14.00 - 15.00		071757
ER 25	15.00 - 16.00		071758
 ER 32	2.00 - 3.00		071761
 ER 32	3.00 - 4.00		071762
 ER 32	4.00 - 5.00		071763
 ER 32	5.00 - 6.00		071764
 ER 32	6.00 - 7.00		071765
 ER 32	7.00 - 8.00		071766
 ER 32	8.00 - 9.00		071767
 ER 32	9.00 - 10.00		071768
 ER 32	10.00 - 11.00		071769
 ER 32	11.00 - 12.00		071770
 ER 32	12.00 - 13.00		071771
 ER 32	13.00 - 14.00		071772
 ER 32	14.00 - 15.00		071773
 ER 32	15.00 - 16.00		071774
 ER 32	16.00 - 17.00		071775
 ER 32	17.00 - 18.00		071776
 ER 32	18.00 - 19.00		071777
 ER 32	19.00 - 20.00		071778
 ER 32	17.00 - 18.00		071776
 ER 32	18.00 - 19.00		071777
 ER 32	19.00 - 20.00		071778

\* Items not contained in set.

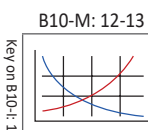

 = Metric (mm)

## Accessories for Collet Chucks

ISO 15488-B (DIN 6499-B)

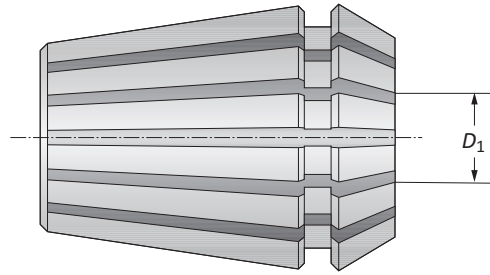

	Nominal Size	Diameter		Part No.
		$D_1$		
	ER 40	3.00 - 4.00		<b>071779</b>
	ER 40	4.00 - 5.00		<b>071780</b>
	ER 40	5.00 - 6.00		<b>071781</b>
	ER 40	6.00 - 7.00		<b>071782</b>
	ER 40	7.00 - 8.00		<b>071783</b>
	ER 40	8.00 - 9.00		<b>071784</b>
	ER 40	9.00 - 10.00		<b>071785</b>
	ER 40	10.00 - 11.00		<b>071786</b>
	ER 40	11.00 - 12.00		<b>071787</b>
	ER 40	12.00 - 13.00		<b>071788</b>
<b>m</b>	ER 40	13.00 - 14.00		<b>071789</b>
	ER 40	14.00 - 15.00		<b>071790</b>
	ER 40	15.00 - 16.00		<b>071791</b>
	ER 40	16.00 - 17.00		<b>071792</b>
	ER 40	17.00 - 18.00		<b>071793</b>
	ER 40	18.00 - 19.00		<b>071794</b>
	ER 40	19.00 - 20.00		<b>071795</b>
	ER 40	20.00 - 21.00		<b>071796</b>
	ER 40	21.00 - 22.00		<b>071797</b>
	ER 40	22.00 - 23.00		<b>071798</b>
	ER 40	23.00 - 24.00		<b>071799</b>
	ER 40	24.00 - 25.00		<b>071800</b>
	ER 40	25.00 - 26.00		<b>071801</b>

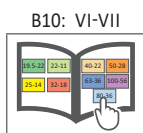
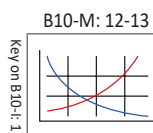

**m** = Metric (mm)

## Collet Sets for Taps DIN 371/374/376

ISO 15488-B (DIN 6499-B)

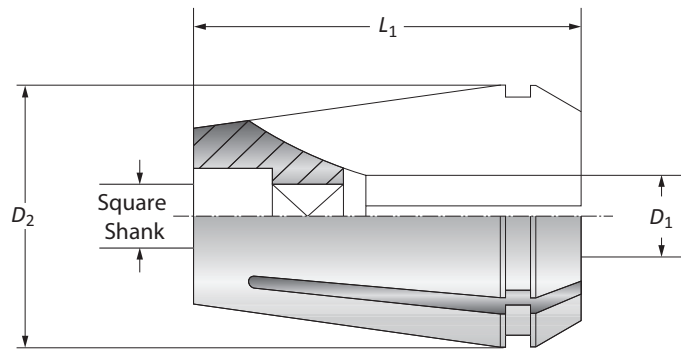

### Collet Sets

	Nominal Size	Standard-No.	Clamping Range $D_1$	Collet Set		Part No.
				$D_2$	$L_1$	
m	ER 16	426 EGB	4.50 - 7.00	16.00	27.50	071045
	ER 25	430 EGB	4.50 - 12.00	25.00	34.00	071047
	ER 32	470 EGB	4.50 - 16.00	32.00	40.00	071048
	ER 40	472 EGB	7.00 - 20.00	40.00	46.00	071049

**NOTE:** To lock these collets, we recommend using the clamping nuts with sliding ring for higher clamping forces.

### Taps

	Shank		Tap		
	$D_1$	Square Shank	DIN 371	DIN 374	DIN 376
m	4.50	3.40	M 4	M 6 x...	M 6
	5.50	4.30	-	M 7 x...	M 7
	6.00	4.90	M 4,5/5/6	M 8 x...	M 8
	7.00	5.50	M 7	M 9/10 x...	M 9/10
	8.00	6.20	M 8	M 6 x...	M 11
	9.00	7.00	M 9	M 6 x...	M 12
	10.00	8.00	M 10	-	-
	11.00	9.00	-	M 14 x...	M 14
	12.00	9.00	M 12	M 16 x...	M 16
	14.00	11.00	-	M 18 x...	M 18
	16.00	12.00	-	M 20 x...	M 20
	18.00	14.00	-	M 22/24 x...	M 22/24
	20.00	16.00	-	M 27 x...	M 27

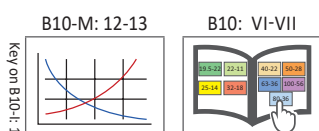

m = Metric (mm)

## Accessories for Collet Sets for Taps DIN 371/374/376

ISO 15488-B (DIN 6499-B)

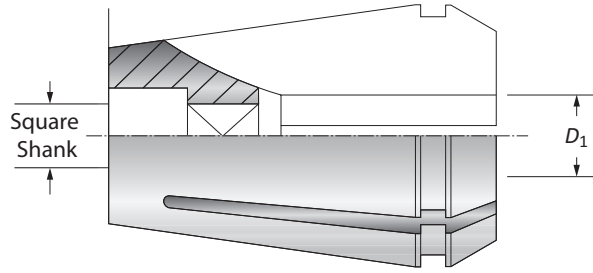

Nominal Size	Suitable Taps		Part No.
	$D_1$	Square Shank	
ER 16	4.50	3.40	071901
ER 16	5.50	4.30	071902
ER 16	6.00	4.90	071903
ER 16	7.00	5.50	071904
ER 25	4.50	3.40	071912
ER 25	5.50	4.30	071913
ER 25	6.00	4.90	071914
ER 25	7.00	5.50	071915
ER 25	8.00	6.20	071916
ER 25	9.00	7.00	071917
ER 25	10.00	8.00	071918
ER 25	11.00	9.00	071919
ER 25	12.00	9.00	071920
ER 32	4.50	3.40	071921
ER 32	5.50	4.30	071922
ER 32	6.00	4.90	071923
ER 32	7.00	5.50	071924
ER 32	8.00	6.20	071925
ER 32	9.00	7.00	071926
ER 32	10.00	8.00	071927
ER 32	11.00	9.00	071928
ER 32	12.00	9.00	071929
ER 32	14.00	11.00	071930
ER 32	16.00	12.00	071931
ER 40	7.00	5.50	071932
ER 40	8.00	6.20	071933
ER 40	9.00	7.00	071934
ER 40	10.00	8.00	071935
ER 40	11.00	9.00	071936
ER 40	12.00	9.00	071937
ER 40	14.00	11.00	071938
ER 40	16.00	12.00	071939
ER 40	18.00	14.50	071940
ER 40	20.00	16.00	071941

Ⓜ

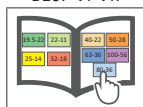
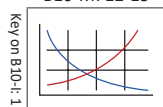

## Accessories for Collet Chucks: ISO 15488-B (DIN 6499-B)

### Collets

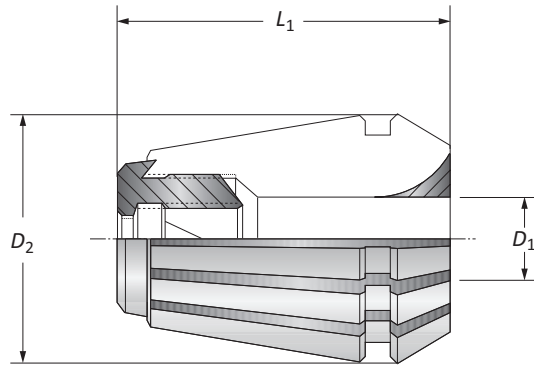

#### Collets for Mill Cutters with Pull Thread System

	Nominal Size	Standard-No.	Clamping Range $D_2$	Collet		Part No.
				$L_1$	$D_1$	
Ⓜ	ER 32	470 ECL	32.00	46.00	6.00 - 16.00	071052
	ER 40	472 ECL	40.00	52.00	6.00 - 25.00	071053

### Collets

	Collet		Part No.
	Nominal Size	$D_1$	
Ⓜ	ER 32	6.00	071826
	ER 32	8.00	071827
	ER 32	10.00	071828
	ER 32	12.00	071829
	ER 32	16.00	071830
	ER 40	6.00	071831
	ER 40	8.00	071832
	ER 40	10.00	071833
	ER 40	12.00	071834
	ER 40	16.00	071835
	ER 40	20.00	071836
	ER 40	25.00	071837

**NOTE:** To lock these collets, we recommend using the clamping nuts with sliding ring for higher clamping forces.

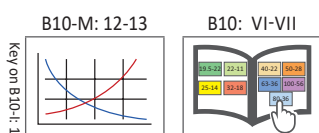

Ⓜ = Metric (mm)